

**ASSEMBLY INSTRUCTIONS  
INSTRUCTIONS DE MONTAGE**

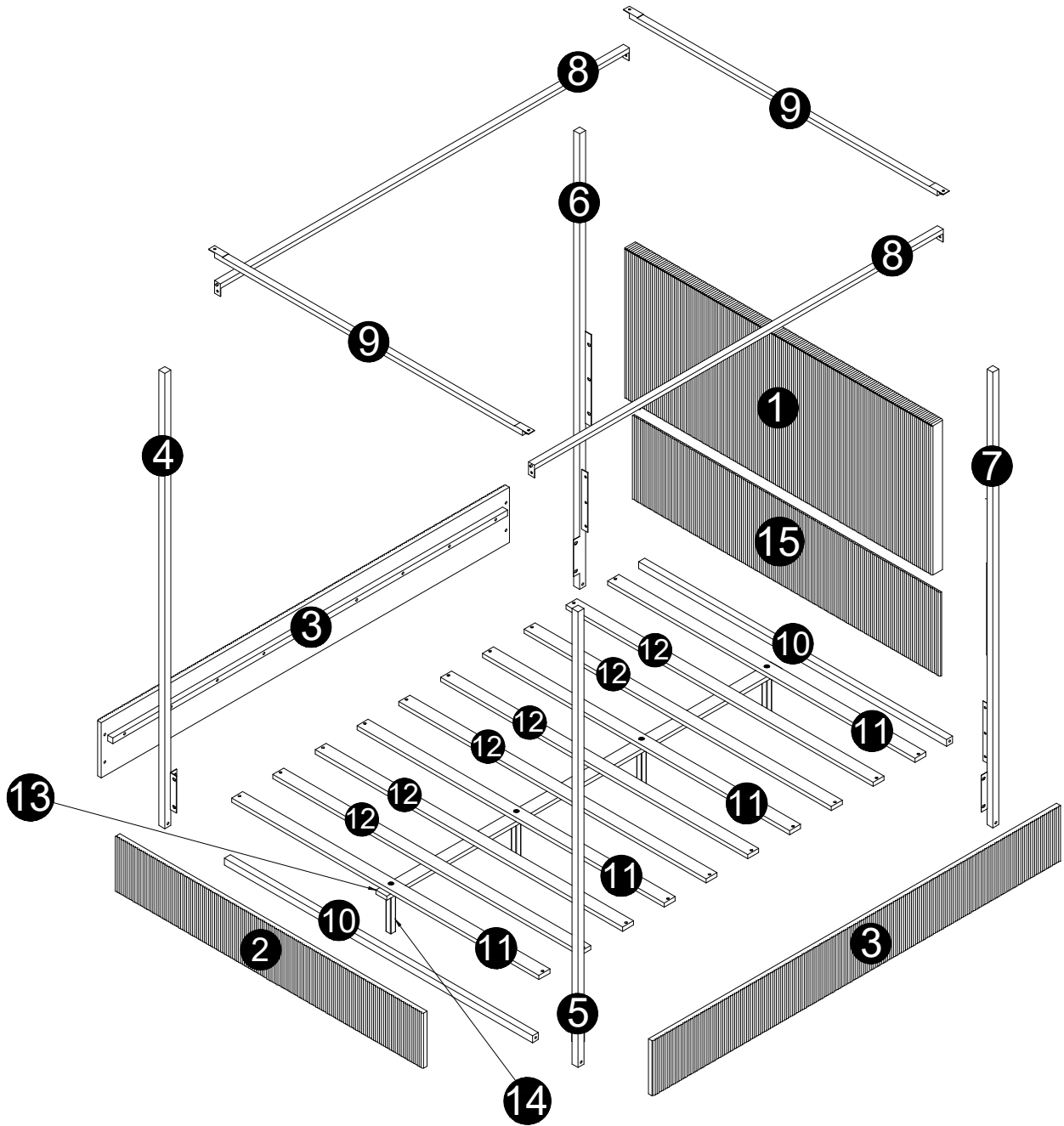

**PARTS**  
**LES PIÈCES**

**BOX:1/2**

check that you've received all parts  
listed below  
vérifiez que vous avez reçu toutes les  
pièces répertoriées ci-dessous

**1** (1PC)

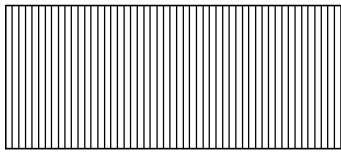

Head Board  
Tête de lit

**15** (1PC)

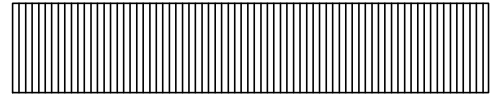

Support Bar  
Bar de soutien

**2** (1PC)



Foot Board  
Planche à pied

**11** (4PCS)

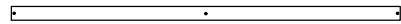

Slats  
Lattes

**12** (6PCS)

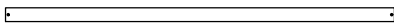

Slats  
Lattes

**14** (4PCS)

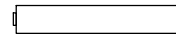

Support Legs  
Jambes de soutien

**HARDWARE**

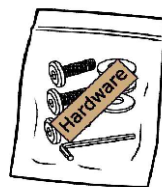

# PARTS LES PIÈCES

BOX:2/2

check that you've received all parts  
listed below  
vérifiez que vous avez reçu toutes les  
pièces répertoriées ci-dessous

**3** (2PCS)

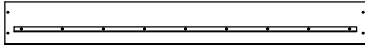

Side Board  
Panneau latéral

**5** (1PC)

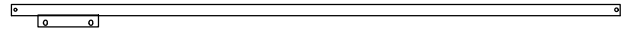

Bed Footboard Post  
poteau de pied de lit

**4** (1PC)

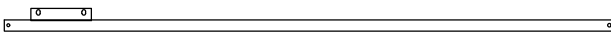

Bed Footboard Post  
poteau de pied de lit

**7** (1PC)

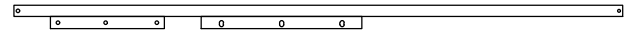

Bed Headboard Post  
poteau de tête de lit

**6** (1PC)

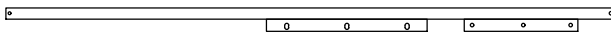

Bed Headboard Post  
poteau de tête de lit

**9** (2PCS)

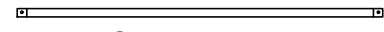

Short Top Bar  
barre courte en haut

**8** (2PCS)

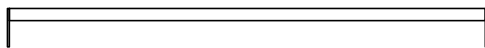

Long Top Bar  
Longue barre en haut

**13** (1PC)

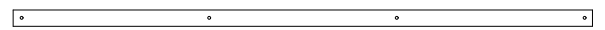

Support Slat  
Latte de support









**10** (2PCS)







bottom reinforcement  
renfort inférieur

# HARDWARE LIST

## LISTE DU MATÉRIEL



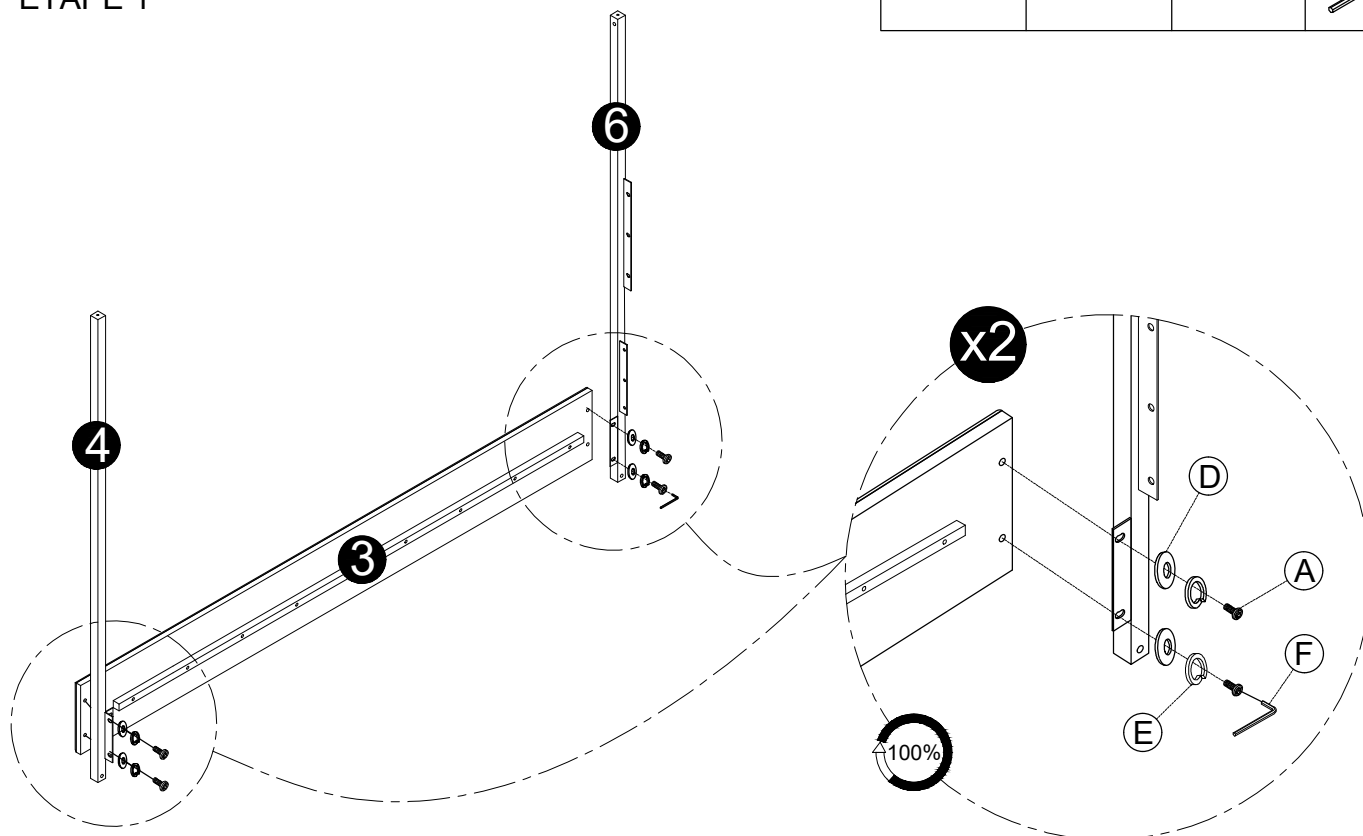

NO	OUTLOOK	DESC	QTY
A		Bolts 5/16*20mm	26 pcs
B		Bolts 5/16*50mm	4 pcs
C		Bolts 5/16*70mm	4 pcs
D		Flat washer Ø19x1.5 mm	34 pcs
E		Spring washer Ø13x1 mm	34 pcs
F		Allen Wrench 80x30x4 mm	1 pc
G		Screws Ø4x30 mm	20 pcs
H		L- Bracket 19x19*2 mm	4 pcs
I		Screws Ø4x12 mm	14 pcs

STEP 1  
ÉTAPE 1

Ax4 	Dx4 	Ex4 	Fx1 
--	--	--	---





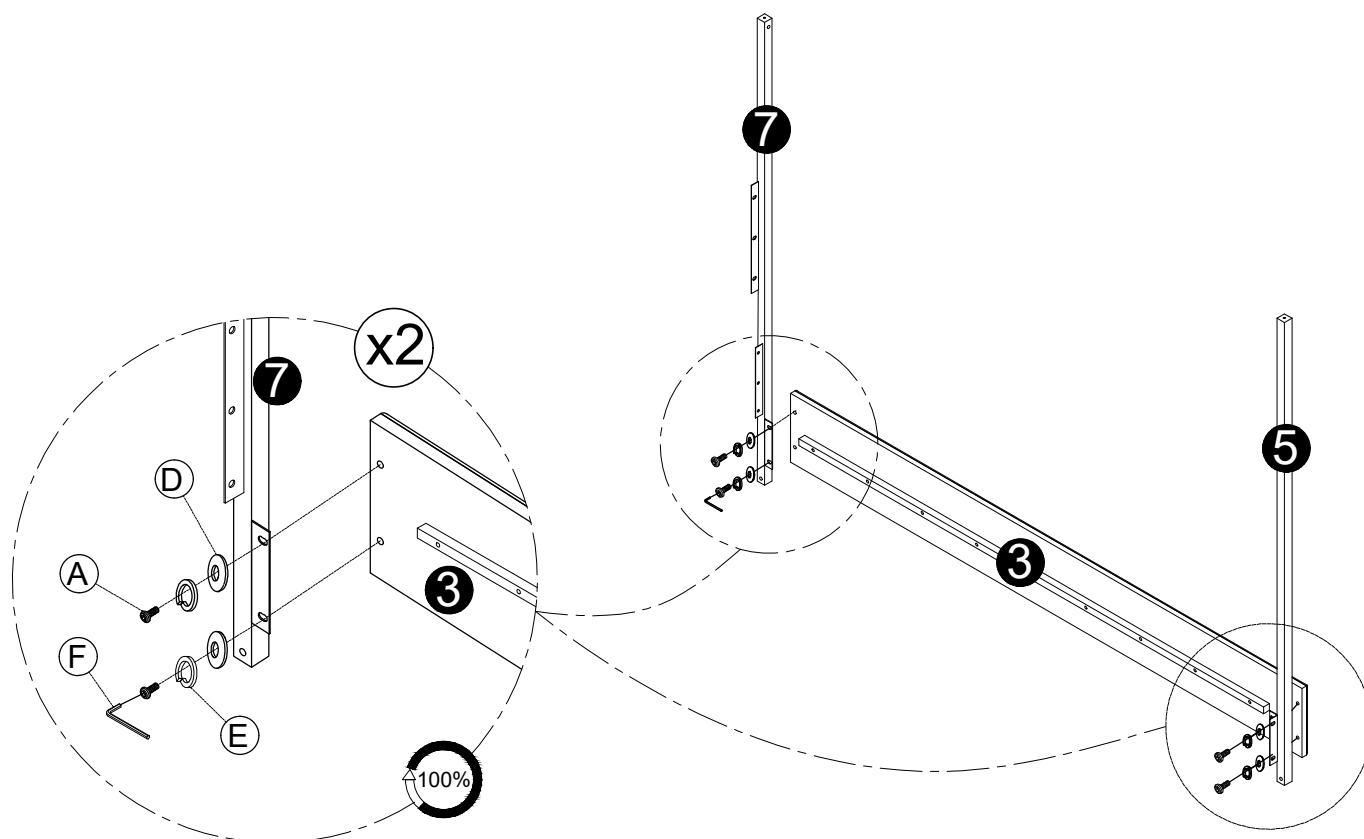

STEP 2  
ÉTAPE 2

Ax4 	Dx4 	Ex4 	Fx1 
--	--	--	--





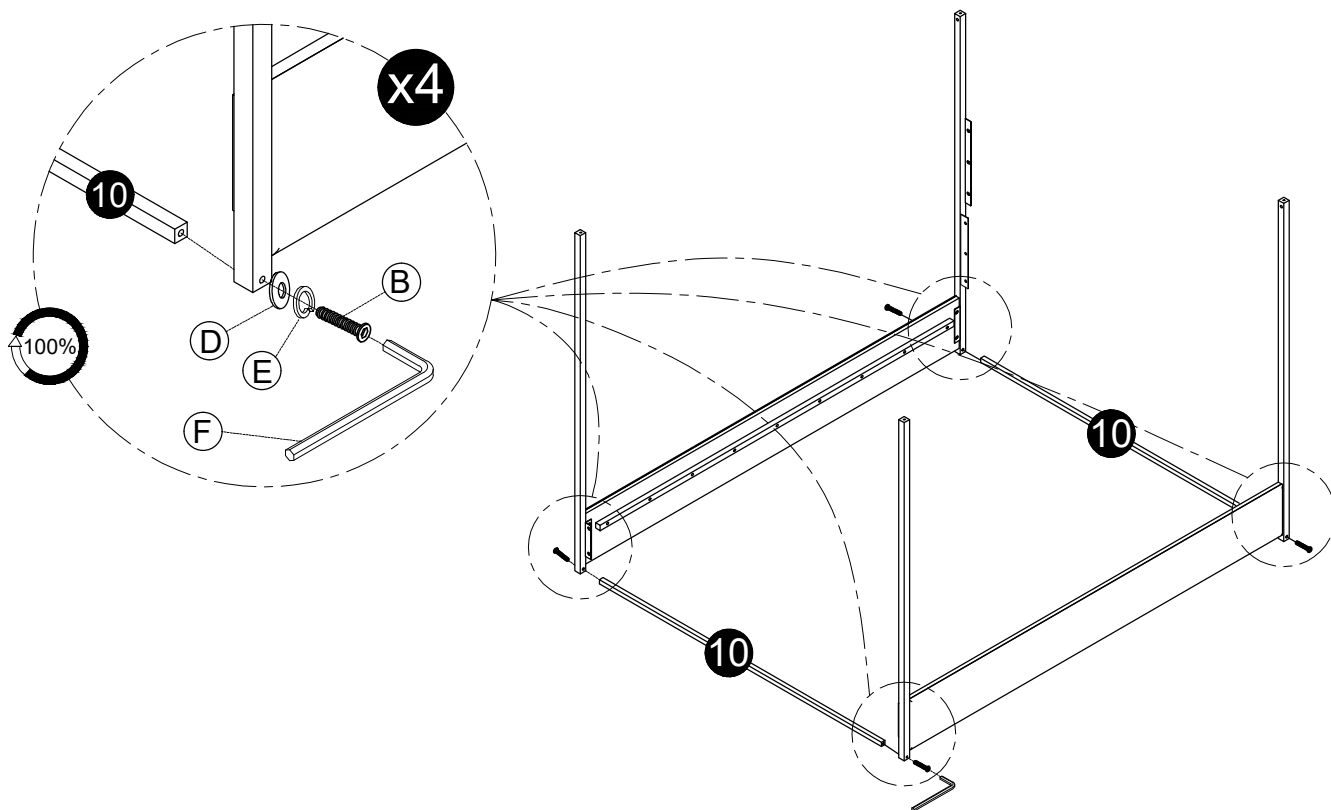

STEP 3  
ÉTAPE 3

Bx4 	Dx4 	Ex4 	Fx1 
---	--	--	--





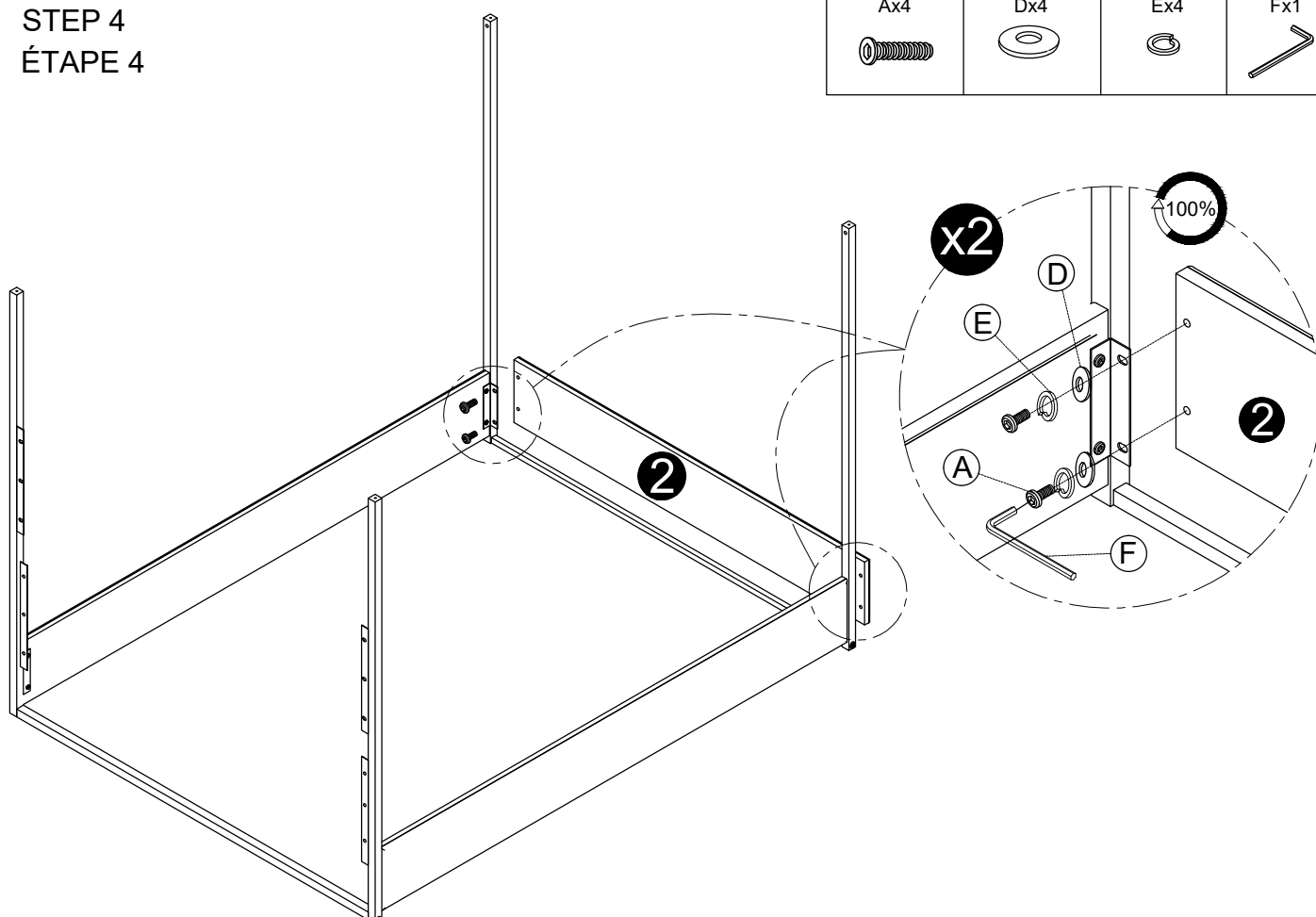

STEP 4  
ÉTAPE 4

Ax4 	Dx4 	Ex4 	Fx1 
---	--	--	--



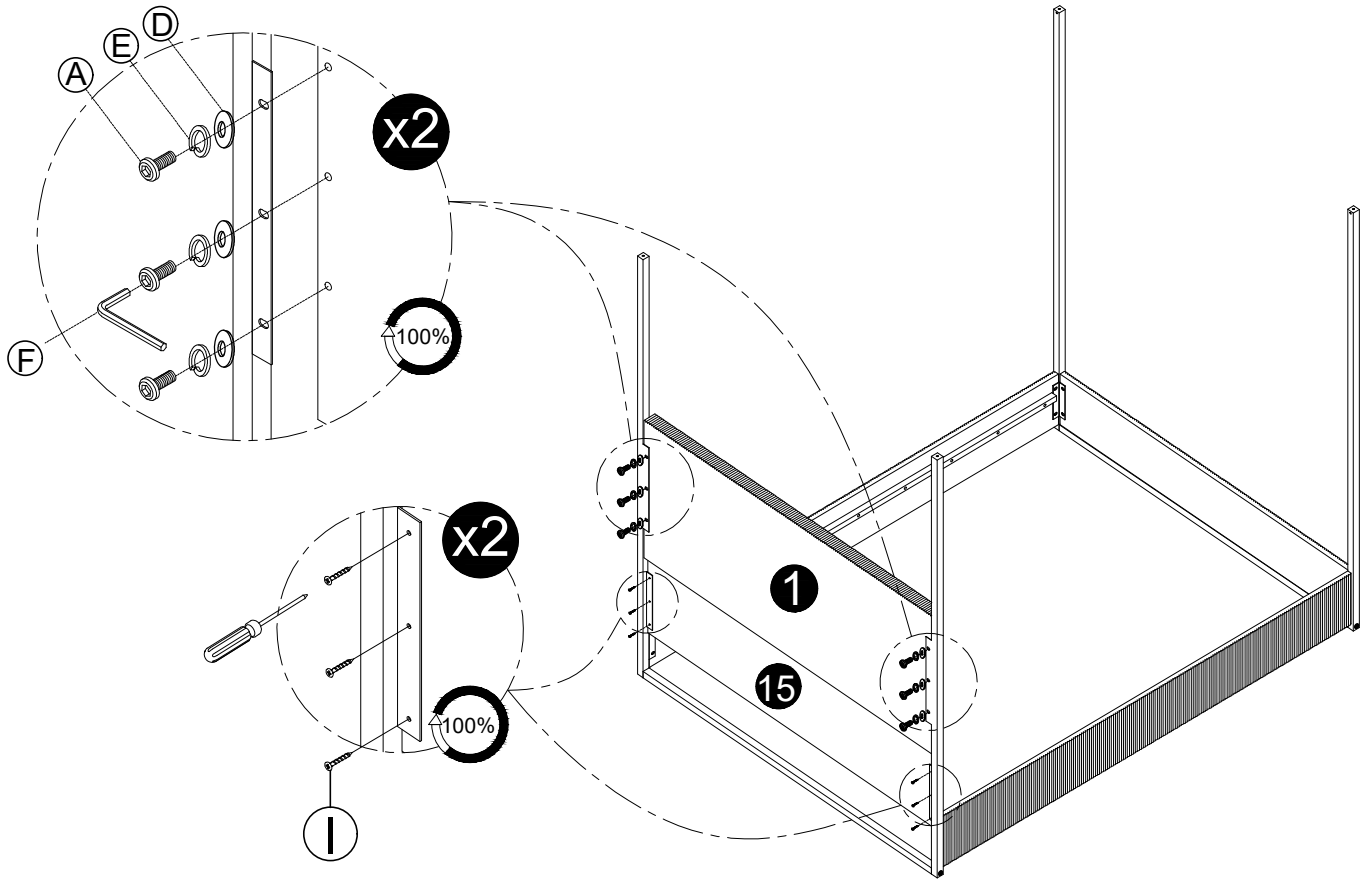

STEP 5  
ÉTAPE 5

Ax6	Dx6	Ex6	Fx1	Ix6
				





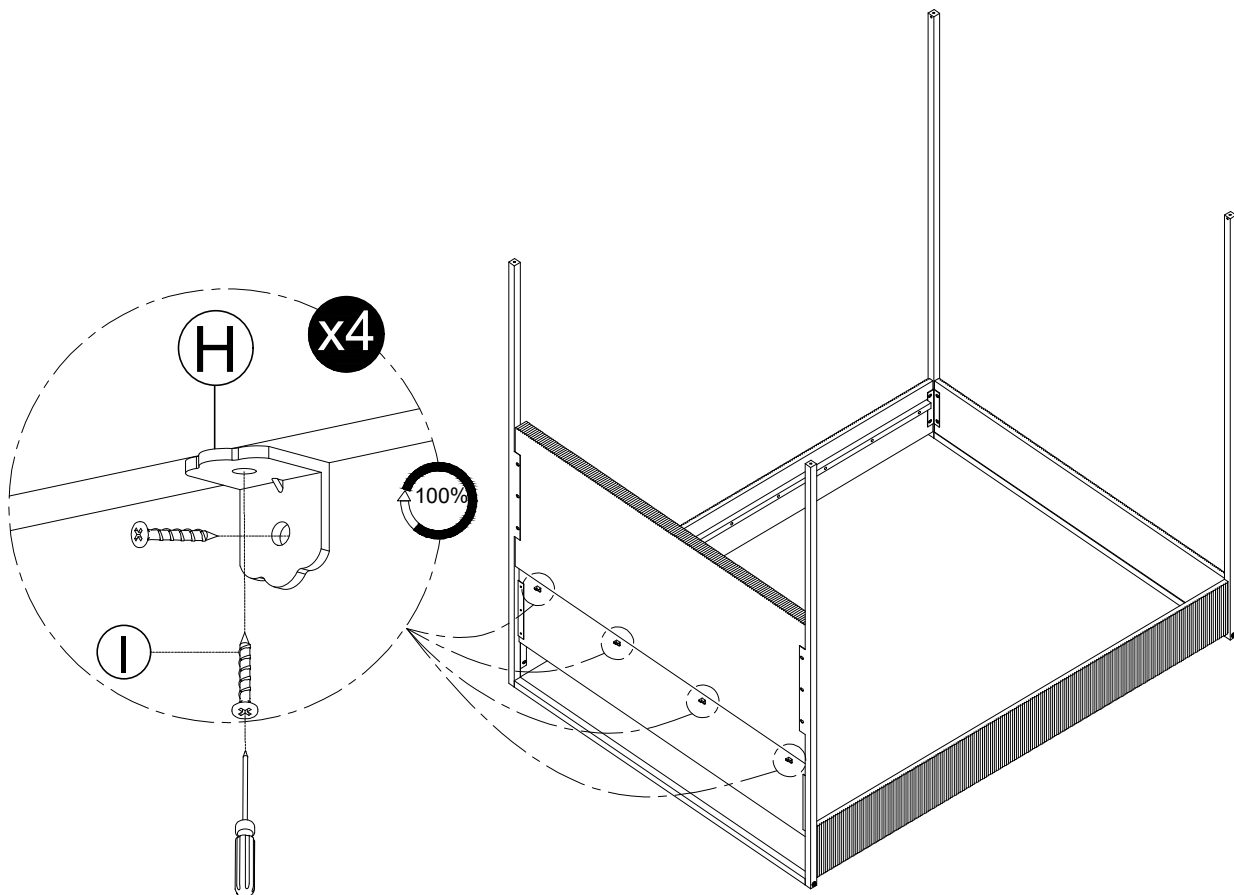

STEP 6  
ÉTAPE 6

Hx4	Ix8
	



STEP 7  
ÉTAPE 7

Cx4 	Dx4 	Ex4 	Fx1 	Gx8 
--	--	--	--	--

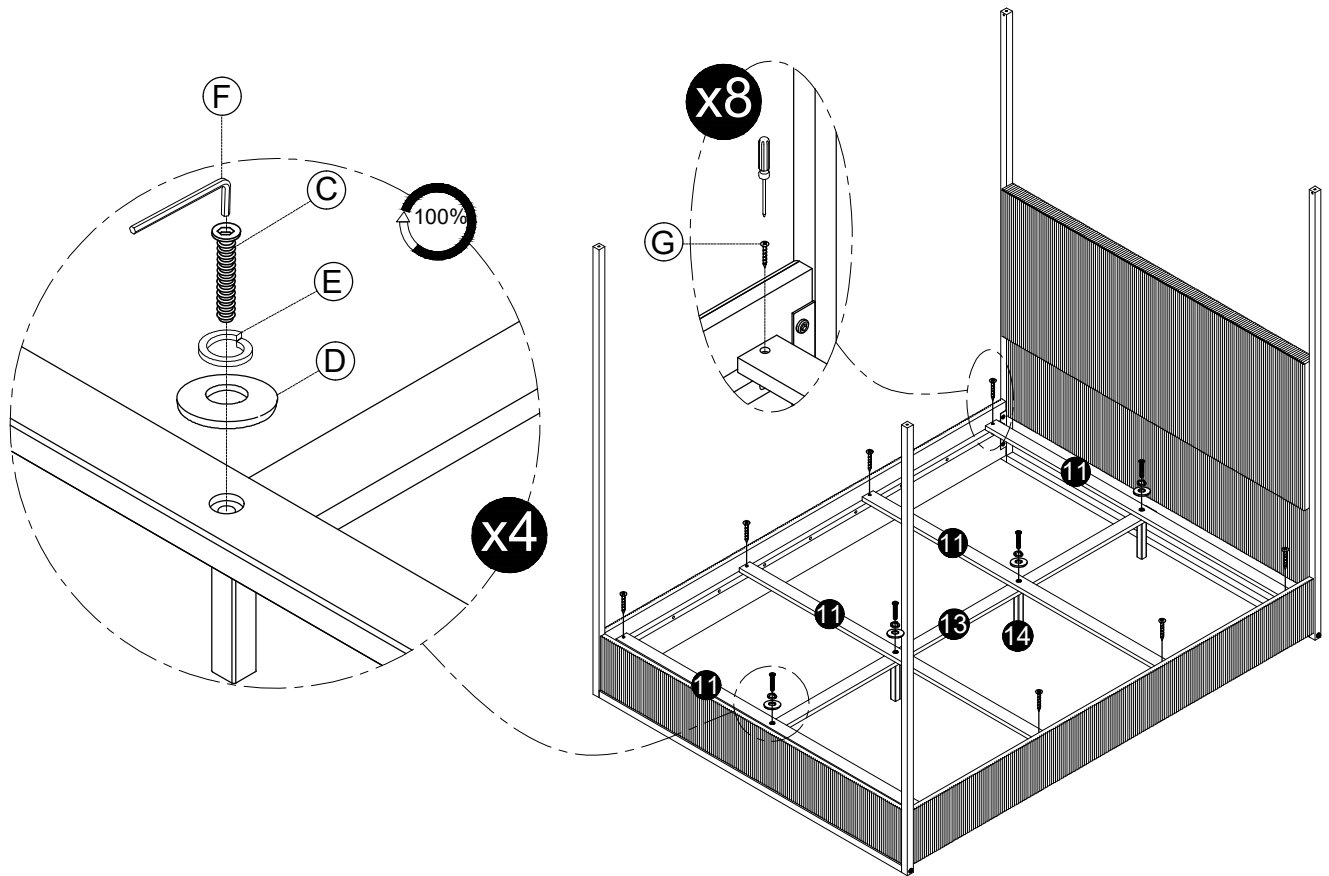



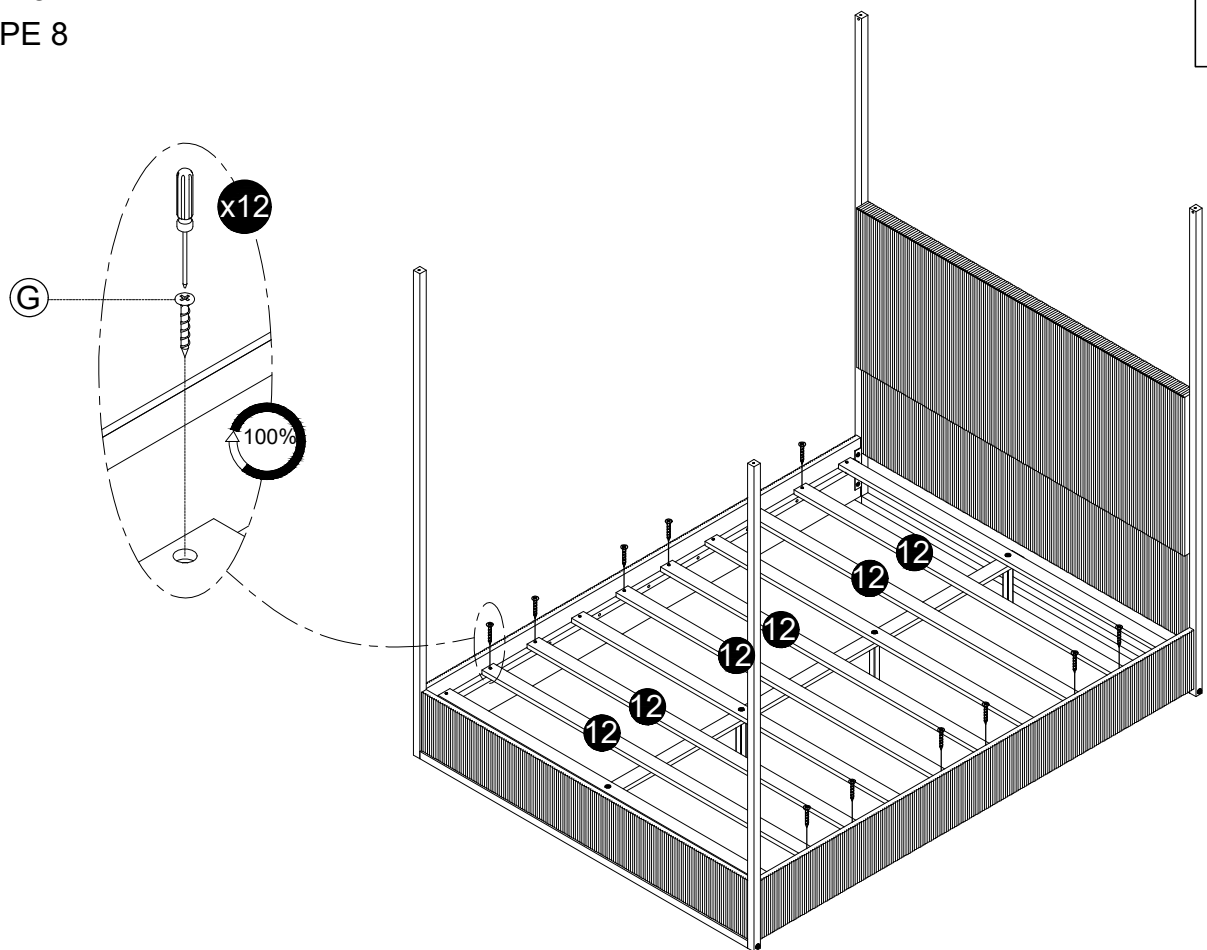

STEP 8  
ÉTAPE 8

Gx12 
---



STEP 9  
ÉTAPE 9

Ax8 	Dx8 	Ex8 	Fx1 
--	--	--	--

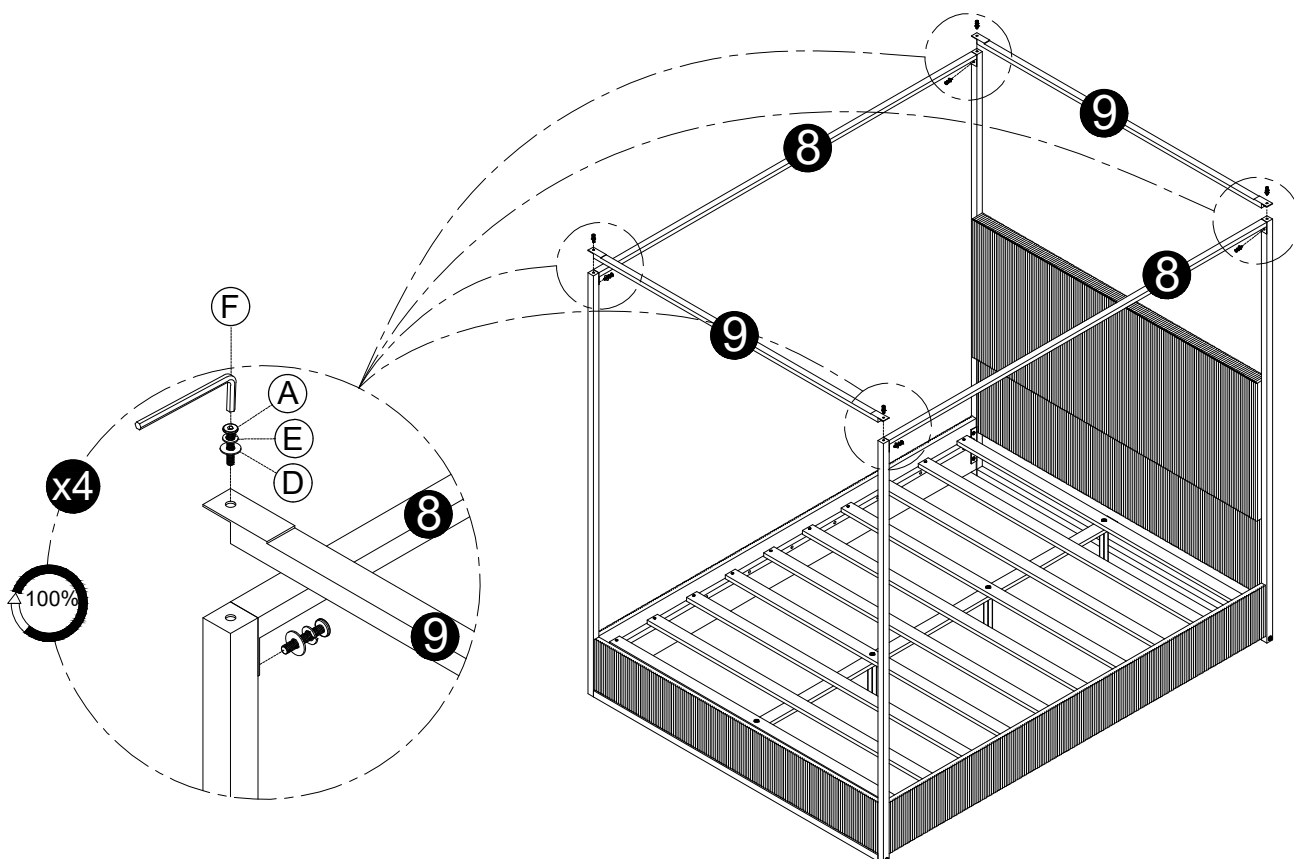

Finish  
Finition

