





# ASSEMBLY INSTRUCTION

1	1PC	CHAIR BACK FRAME	A		1PC	ALLEN KEY M5mm
2	1PC	CHAIR SEAT	B		6PCS	BOLT $\phi 5/16'' * 2-1/4''$
3	2PCS	FRONT LEGS	C		4PCS	BOLT $\phi 5/16'' * 3-1/2''$
			D		10PCS	LOCK WASHER $\phi 5/16''$
			E		10PCS	WASHER $\phi 5/16'' * 22MM$

## STEP 1

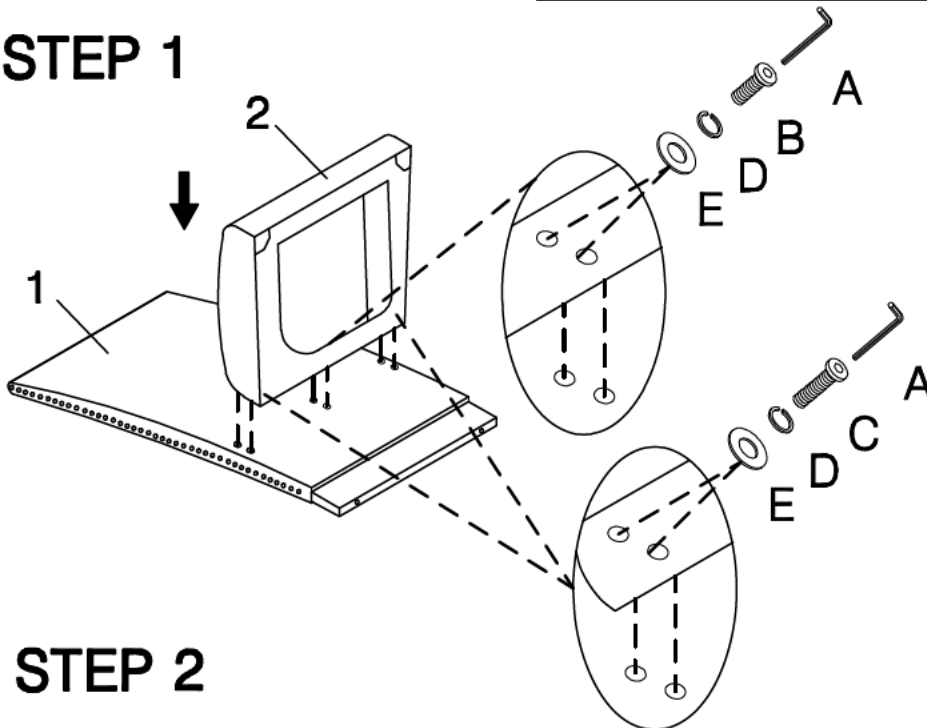

## STEP 2

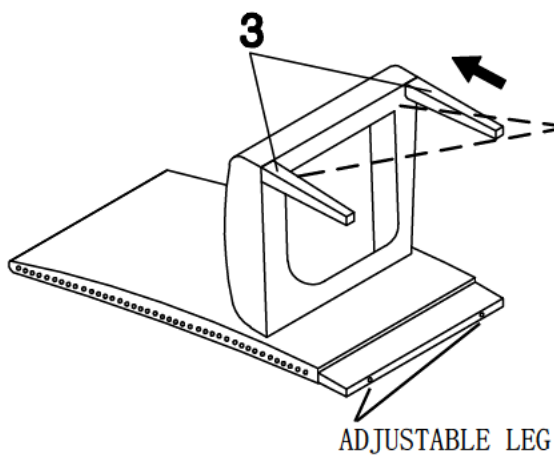

## STEP 3

