

① X2

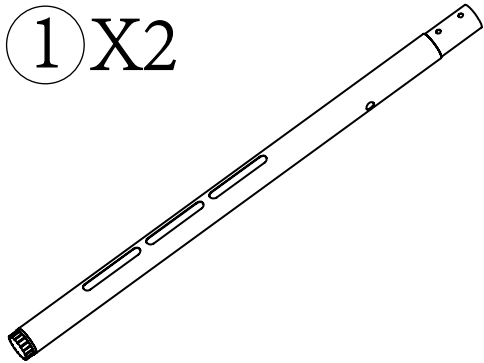

② X1

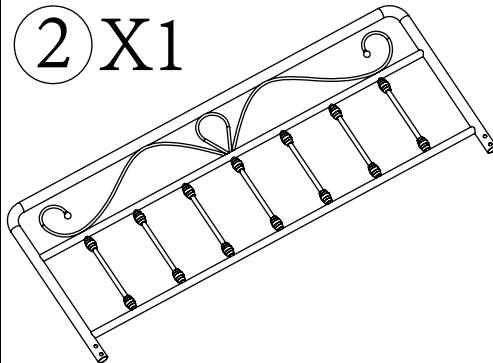

③ X1

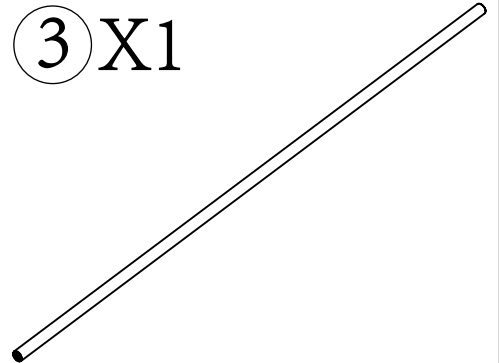

④ X4

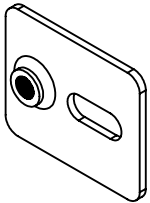

A X4

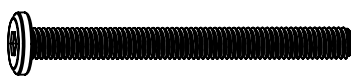

M8X85

B X4



M8X35

C X2



M6X50

D X4

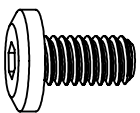

M6X12

E X4



M8

F X4

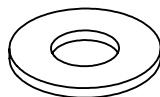

M8

G X4

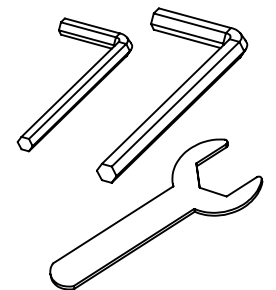

Difference screws display(1:1)

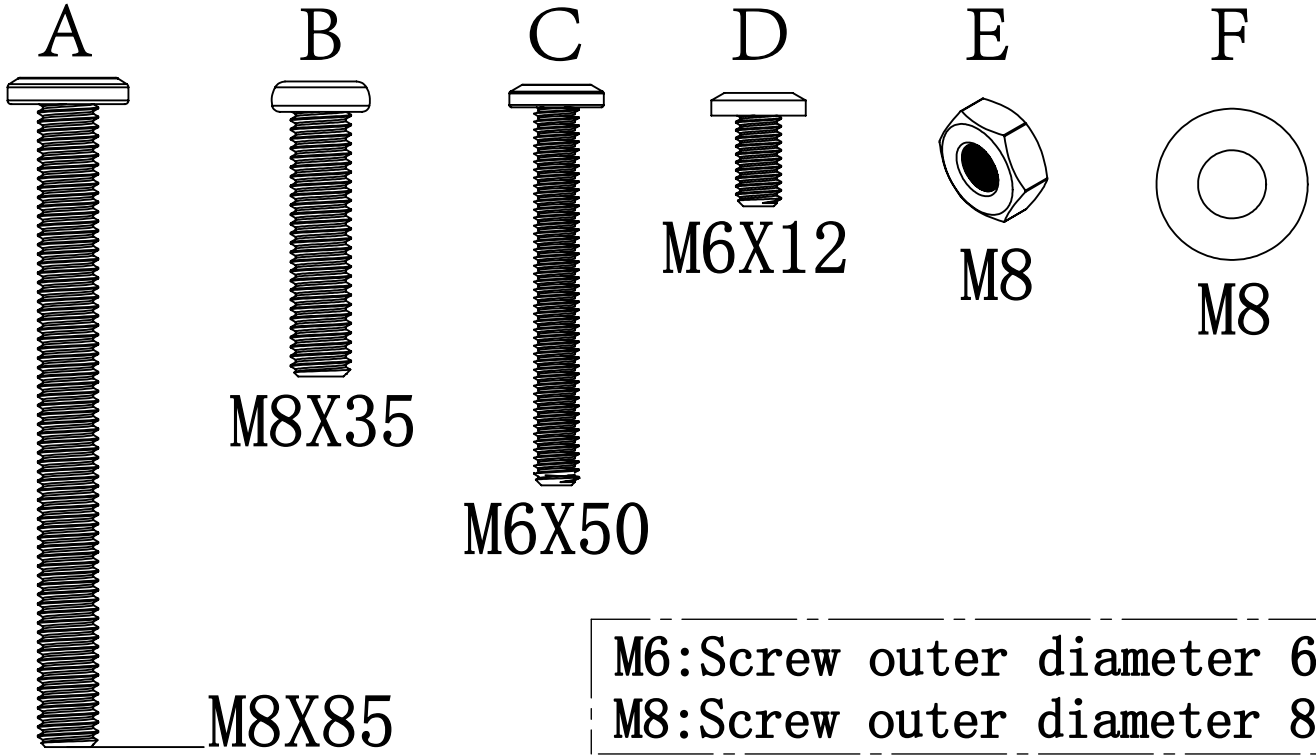

Step 1

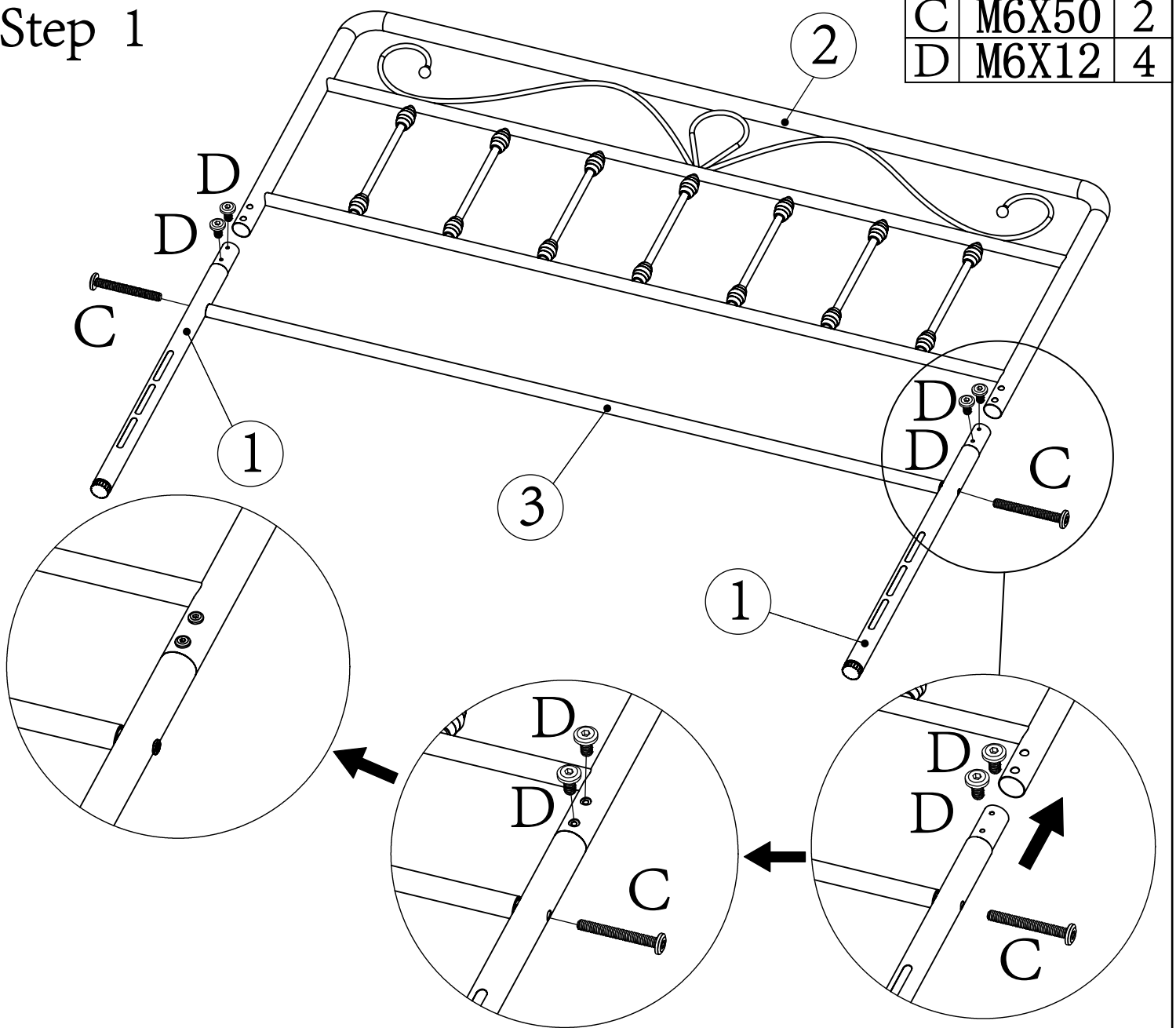

Step 2

A	M8X85	4
B	M8X35	4
E	M8	4
F	M8	4
G		4

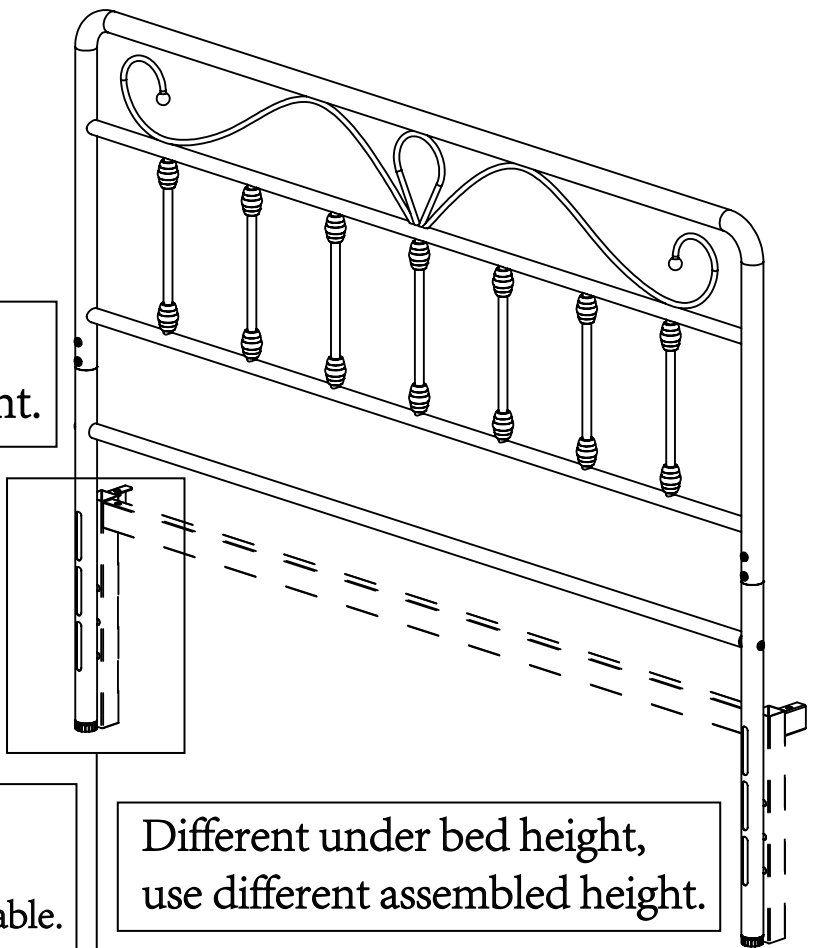

Select the suitable assembly scheme based on the requirement.

★ :When assembling Part 4, please pay attention to the direction. The direction to the left or right is adjustable.

Different under bed height, use different assembled height.

1

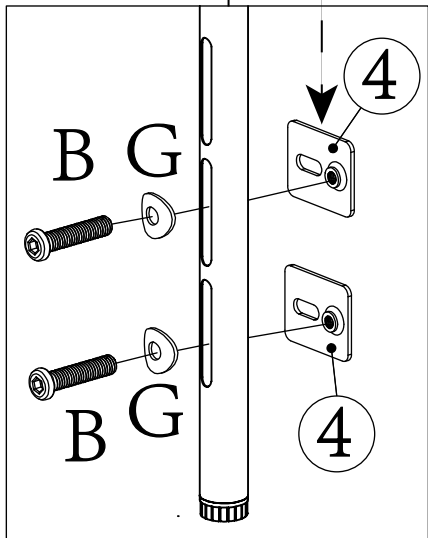

2

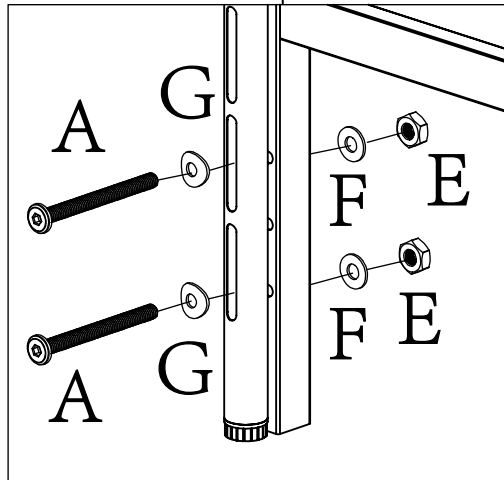

3

