

# INSTALLATION INSTRUCTIONS

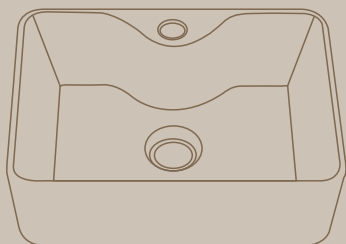

**Wall-hung Sink**

---

# Wall-hung Sink

---

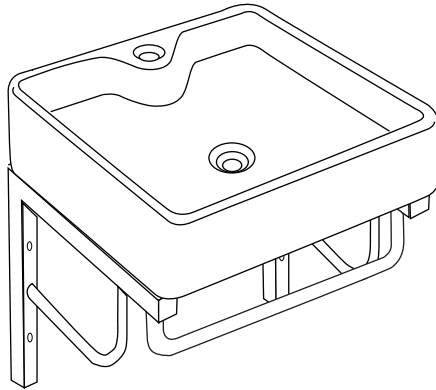

Questions, problems, missing parts?  
Before returning to the store, email  
Our Customer Service

---

*THANK YOU*

# Safety Information

Before installing this sink, read this instruction manual carefully. It contains important information concerning the safe installation, operation, and maintenance of your sink. Retain this manual for future use. In the event of sale, transfer, or relocation, ensure this manual remains with the sink.



**WARNING:** *Keep all packaging materials out of the reach of children to prevent possible choking or suffocation.*



**WARNING:** *Handle with care. Vitreous chinaware is glass-like with sharp edges if broken. Do not drop, handle roughly, or overtighten bolts.*

# Warranty

## LIMITED LIFETIME WARRANTY

Our products are manufactured with superior quality standards and workmanship and are backed by our limited lifetime warranty.

Our products are warranted to the original consumer purchaser to be free of defects in materials or workmanship. We will replace FREE OF CHARGE any product or parts that proves defective.

# Pre-Installation

Compare all parts with the Hardware Included and Package Contents lists in this manual. Check the surface of the sink for any flaws or damage, including dents, bends, bumps, or scuff marks. If any damage is noticed or parts are missing, do not proceed with the installation. Contact the Customer Service Team.

## Packing list

Part	Item	Quantity
A	sink	1
B	setscrew set	1
C	consoles	1

## HARDWARE INCLUDED



Hanger bolts



washer



wall anchor



bolts



Decorative cap

## TOOLS REQUIRED



goggles

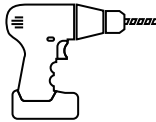

Drill



5/16" diamond  
drill bit



Tape



Ruler

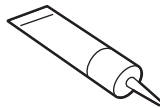

Sealant



Flat  
Shovel



Philips  
screwdriver



Flat  
screwdriver

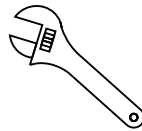

Wrench



Pipe  
Wrench



Expoxy

**IMPORTANT:** We strongly recommends that this product be installed by a licensed plumber. Ensure that installation complies with applicable plumbing and building codes.

# Installation

## 1 Assemble The Console

Note that the threaded pipe is mounted on both sides

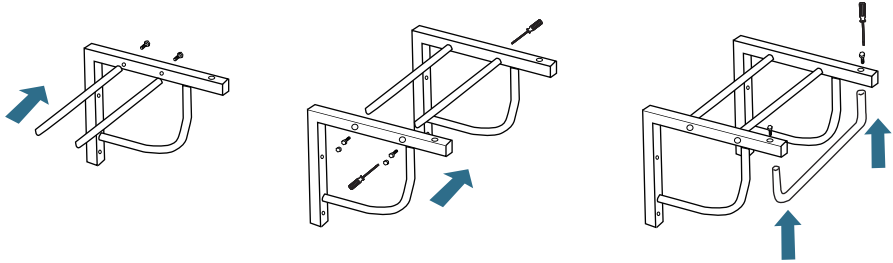

## 2 Install Hanger Bolts

Measure the distance between mounting holes in the back of the sink. Drill pilot holes in wood and screw in hanger bolts. Check position with a level.

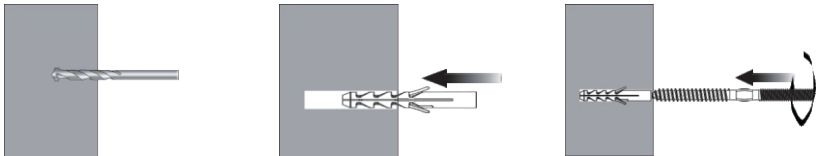

## 3 Install Wall Anchors

Install wall anchors for console base.

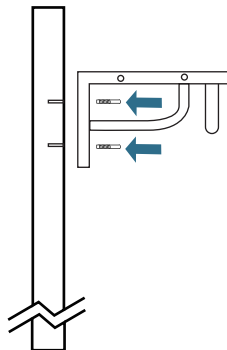

## 4 Install Sink

Apply sealant to the bottom of the sink and place the sink on top of the console

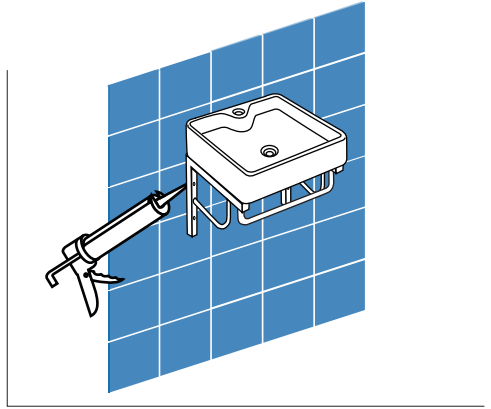

## 5 Sink Accessories

Complete your installation by adding the preferred plumbing accessories, such as the faucet, click-clack drain, p-trap and angle valves to your sink. Faucet and pop-up drainer not included.

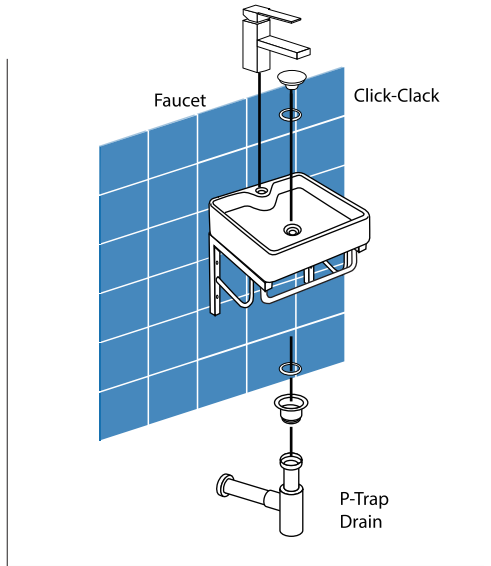

## Care and Cleaning

For best results in caring for your sink, we suggest the following:

- Clean the outside surface with mild soap, warm water, and a soft cloth.
- On stubborn stains, use a powdered detergent and damp sponge or nylon scouring pad.
- Never use abrasive scouring powders, cleansers, or pads because they will scratch, damage, and dull the surface.

