

① x 1

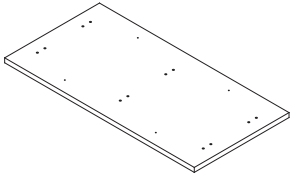

② x 1

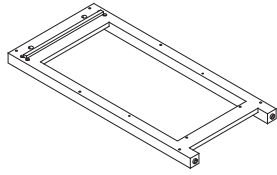

③ x 1

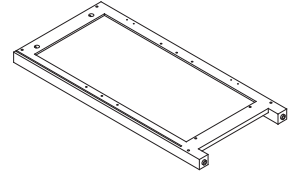

④ x 1

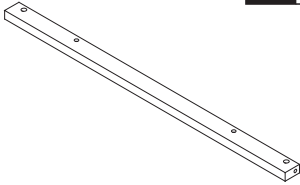

⑤ x 1

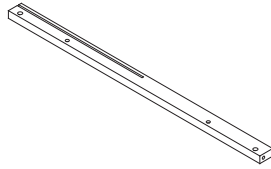

⑥ x 1

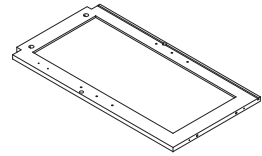

⑦ x 2

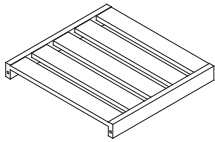

⑧ x 1

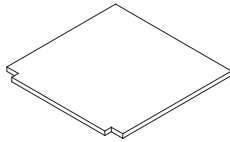

⑨ x 1

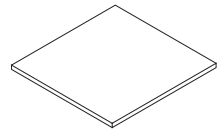

⑩ x 1

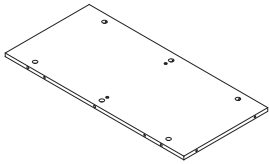

⑪ x 1

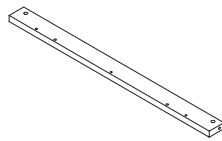

⑫ x 1

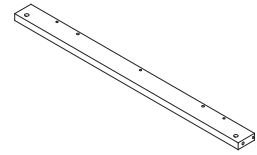

⑬ x 1

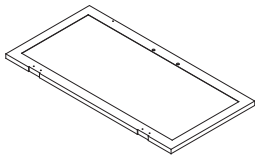

⑭ x 1

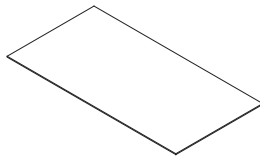

⑮ x 2

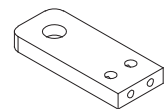

⑯ x 1

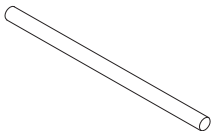

⑰ x 1

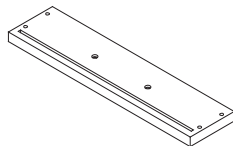

⑱ x 1

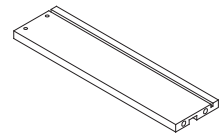

⑲ x 1

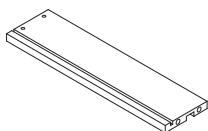

⑳ x 1

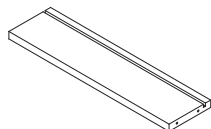

㉑ x 1

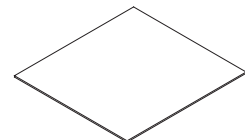

A x 16
+1 (spare)

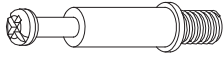

B x 16
+1 (spare)

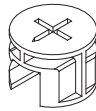

C x 16
+1 (spare)

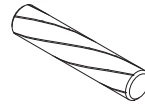

D x 6
+1 (spare)

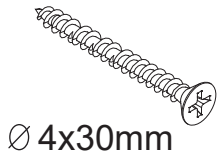

Ø 4x30mm

E x 9
+1 (spare)



Ø 3x12mm

F x 2
+1 (spare)



Ø 3x14mm

G x 2

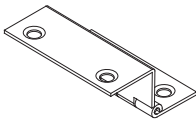

H x 1

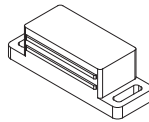

I x 1

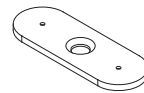

J x 4
+1 (spare)

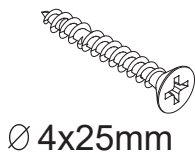

Ø 4x25mm

K x 14
+1 (spare)



Ø 6x60mm

L x 2
+1 (spare)



Ø 6x40mm

M x 16
+1 (spare)



Ø 6x10mm

N x 1

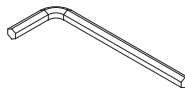

O x 2

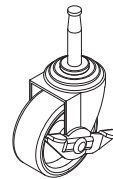

P x 2



Q x 8

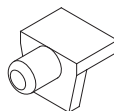

R x 4
+1 (spare)

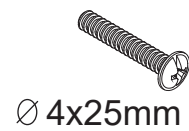

Ø 4x25mm

S x 2



- F** x 2
- H** x 1
- L** x 2
- M** x 2
- N** x 1
- 6** x 1
- 7** x 1

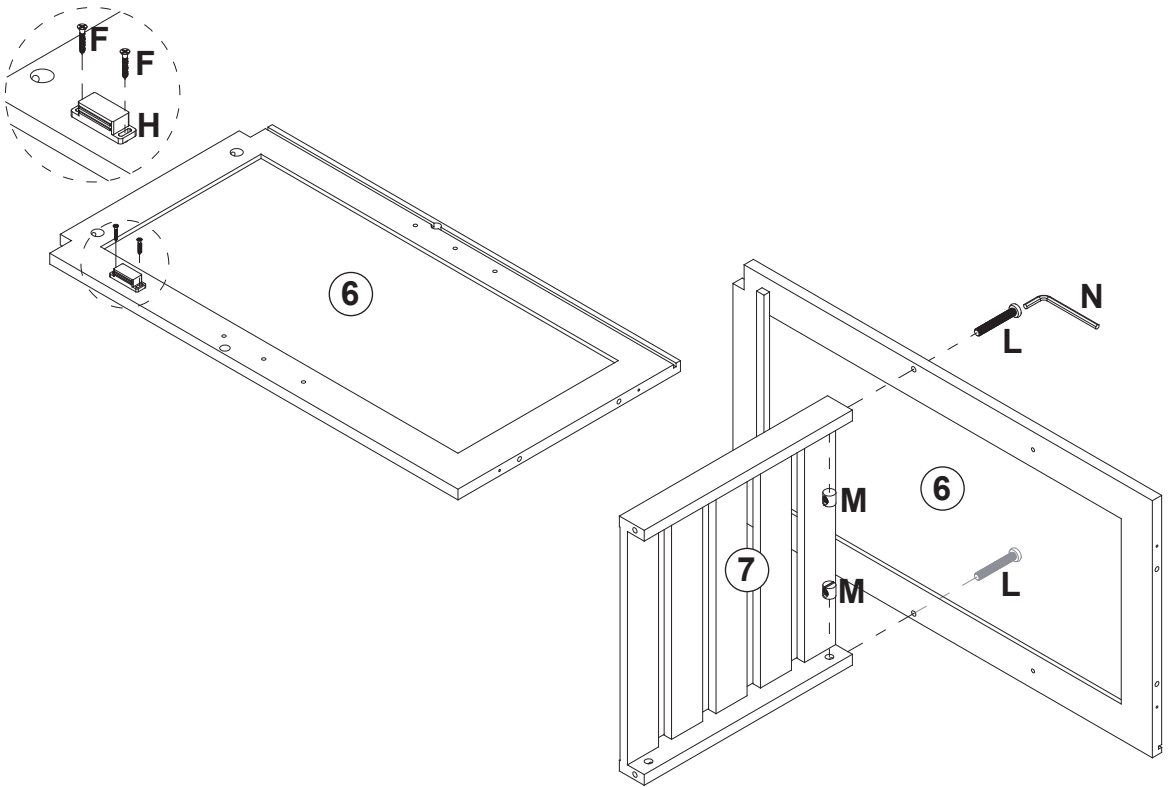

- A** x 6
- B** x 6
- C** x 6
- D** x 2
- 10** x 1
- 11** x 1
- 12** x 1

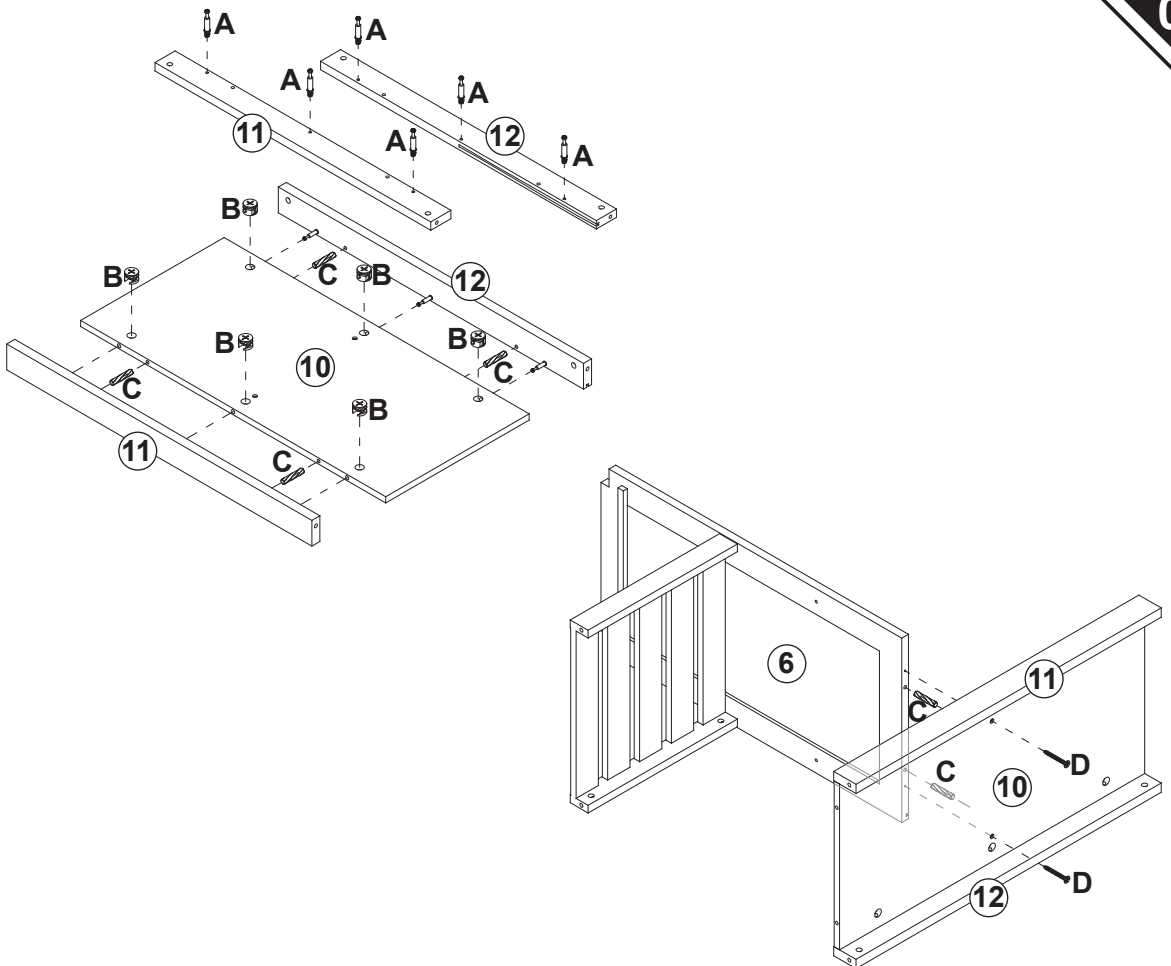

C x 2



K x 6



M x 6



2 x 1

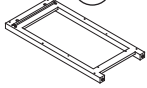

3 x 1

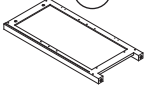

15 x 2



16 x 1

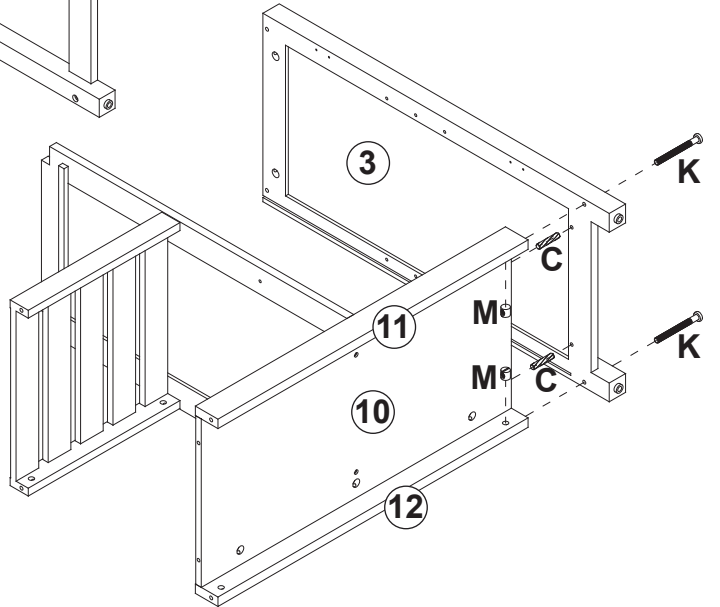
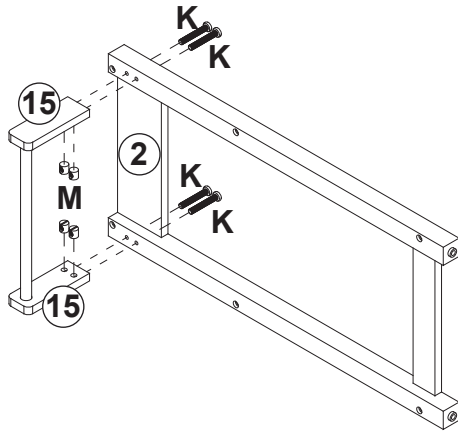
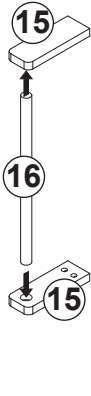

K x 4



O x 2



P x 2



C x 2



M x 4

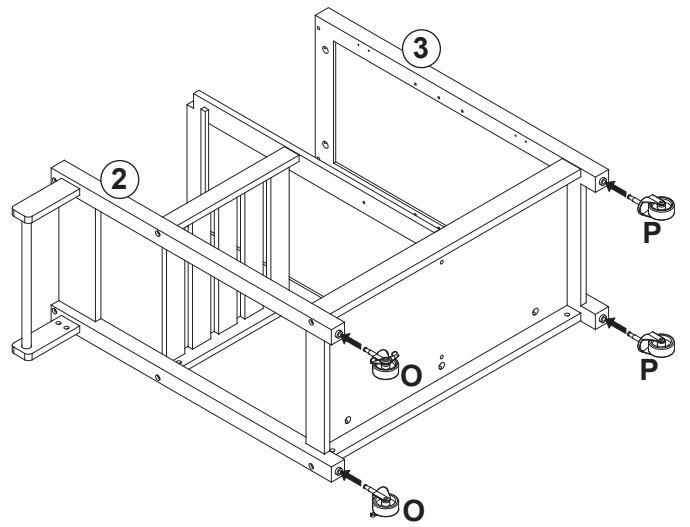
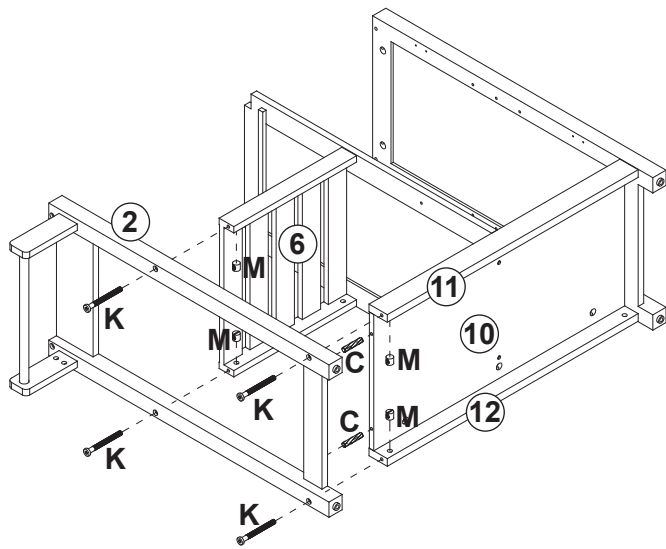

A x 6

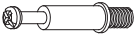

J x 4

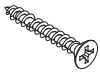

1 x 1

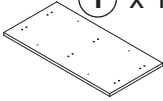

4 x 1

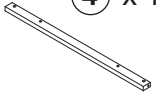

5 x 1



14 x 1

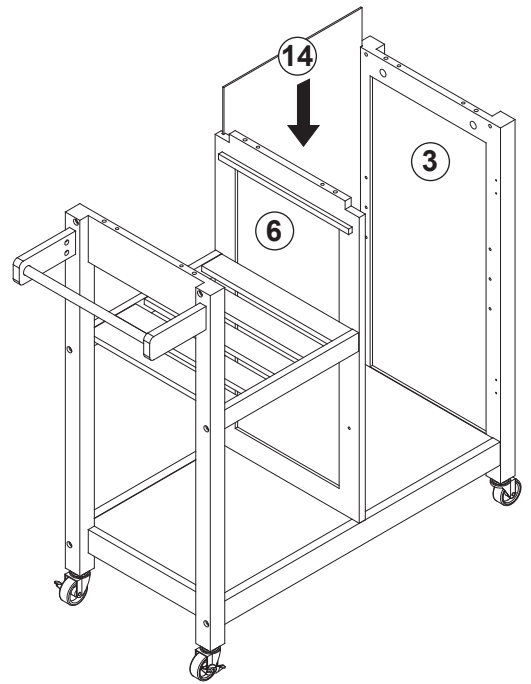
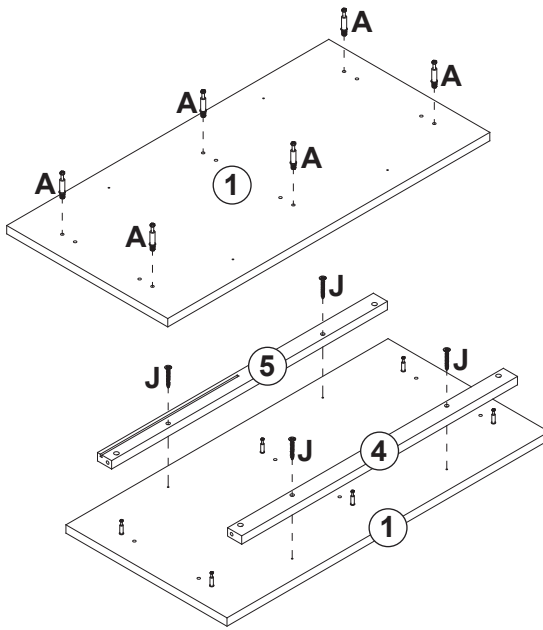

B x 6



C x 6



K x 4



M x 4

