

Assembly Instructions

CAUTION: You must read this before you proceed.

CHAIR

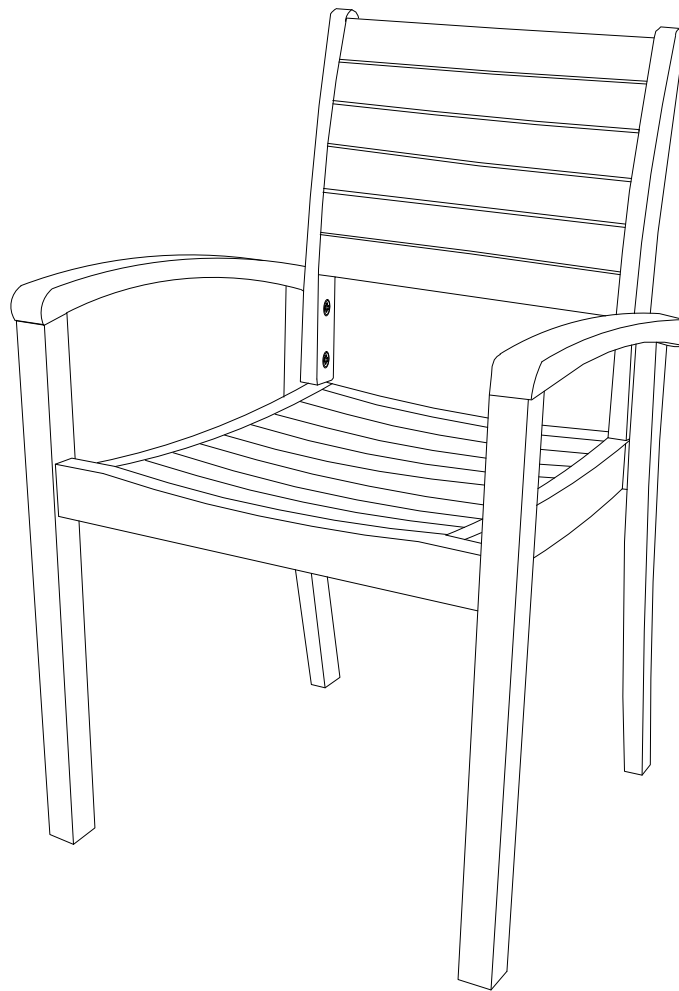

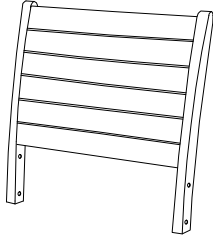
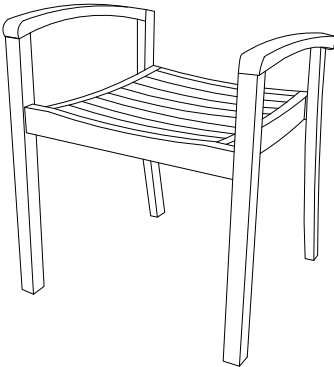

CAUTION: This Chair is NOT a TOY. Keep your child / children at bay in the process of assembly.

Parts List

Label	Picture	Description	QTY
A		Backrest Panel	1
B		Seat Frame	1

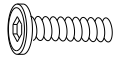
Hardware

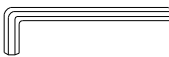
Label	Picture	Description	Qty
①		Bolt (M6 x 40mm)	5
②		Washers M6/12 x 1mm	5
③		Allen Key	1

Assembly Preparation

Before Beginning Assembly:

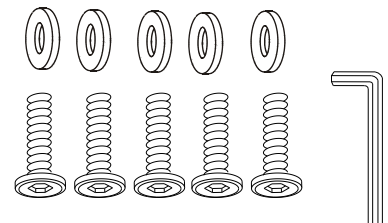
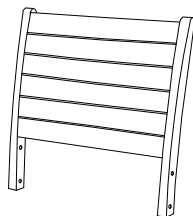
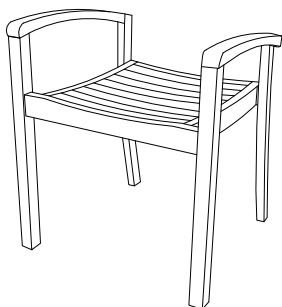

Read instructions, cover to cover.



Have 2 adults on hand for assembly.



Do not assemble on flooring or carpet.



Assemble on a clean non-marring surface (packing foam).



Save all packaging until finished.

Assembly Steps

OVERVIEW

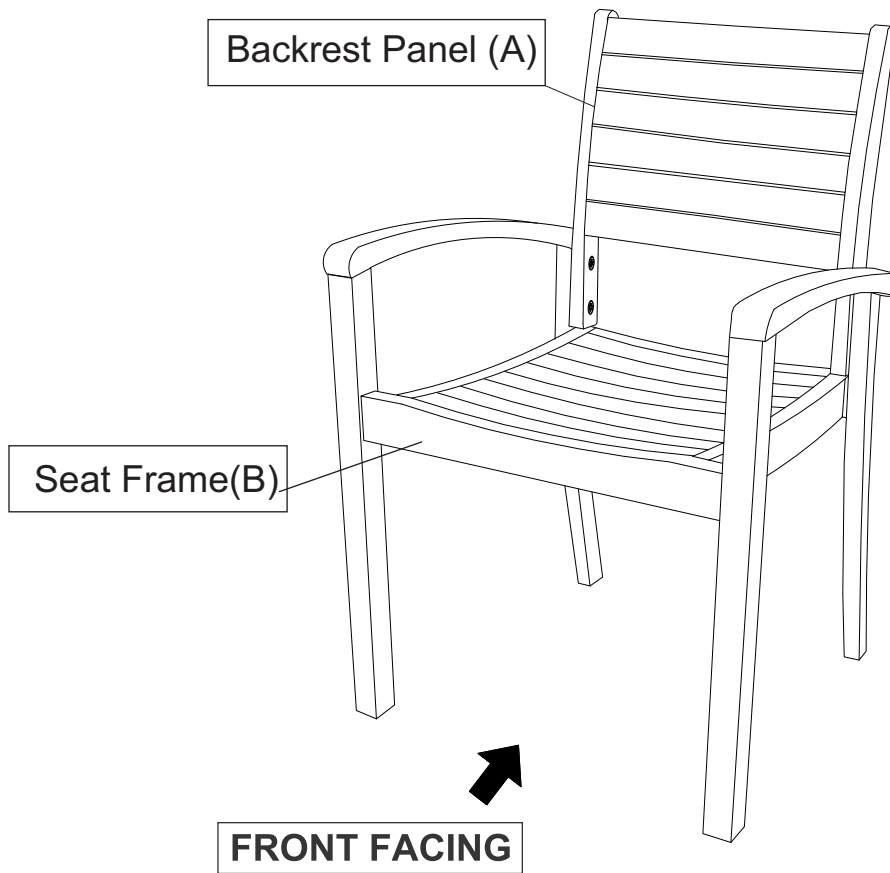

This Chair has multiple parts and may require up to some 15 minutes to assemble. To give you an overview of the chair parts, the above picture is to help you put the various parts into perspective. Please read through the instructions below to familiarise yourself with the parts and steps before assembly.

Step 1

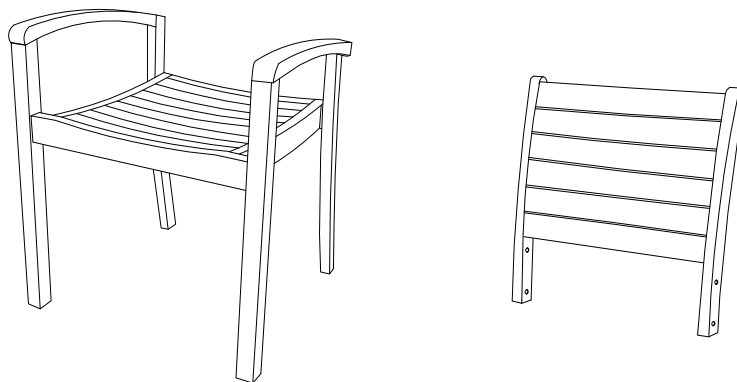

Unpack and place all parts on a clean, non-marring surface.

Assembly Steps

Step 2

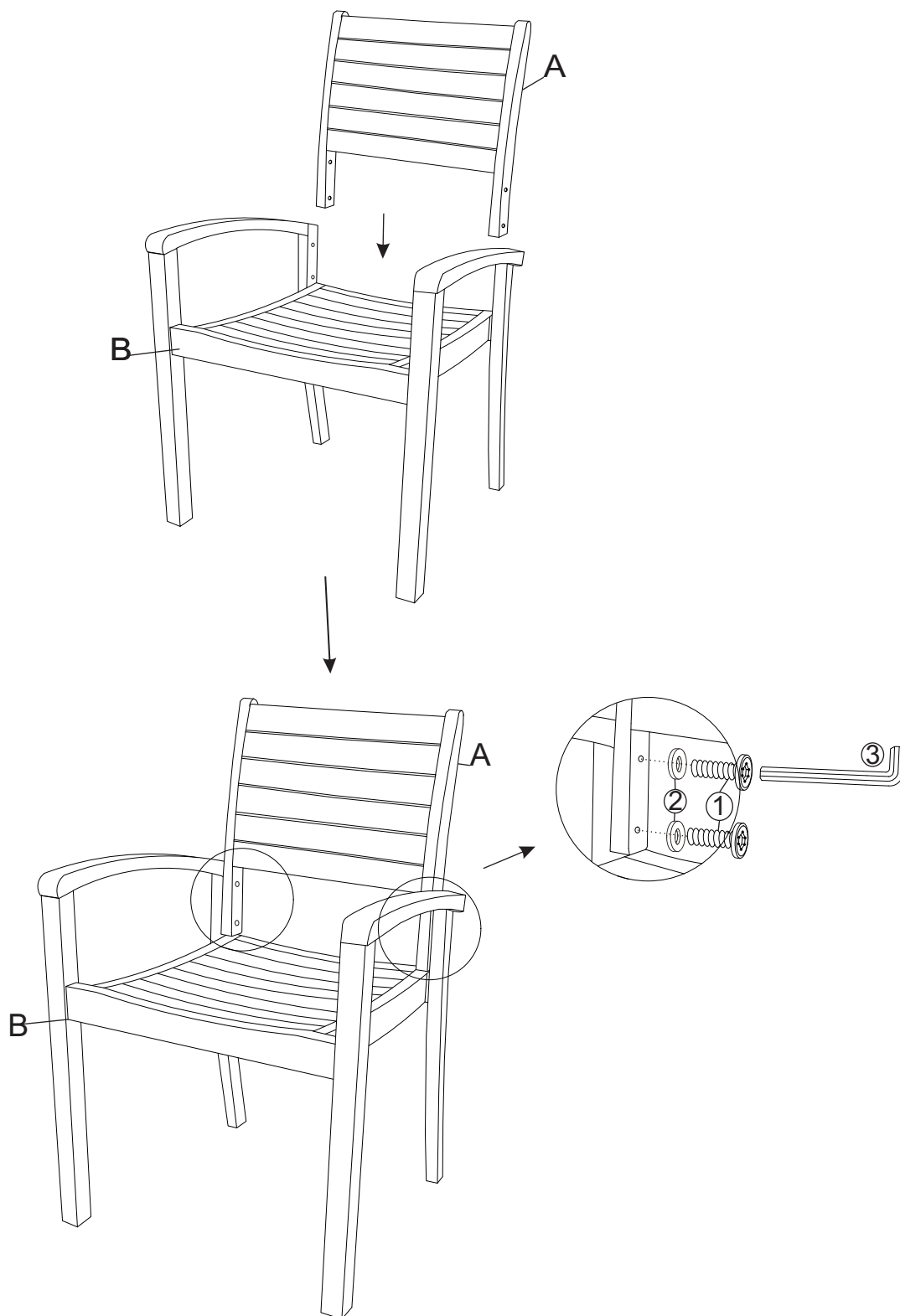

Position Backrest Panel (A) to the Seat Panel (B) as shown in picture above. Then affix Backrest Panel (A) with Seat Panel (B) by using Bolt (1) , Flat Washers (2) and Allen Key (3).

Assembly Steps

Step 3

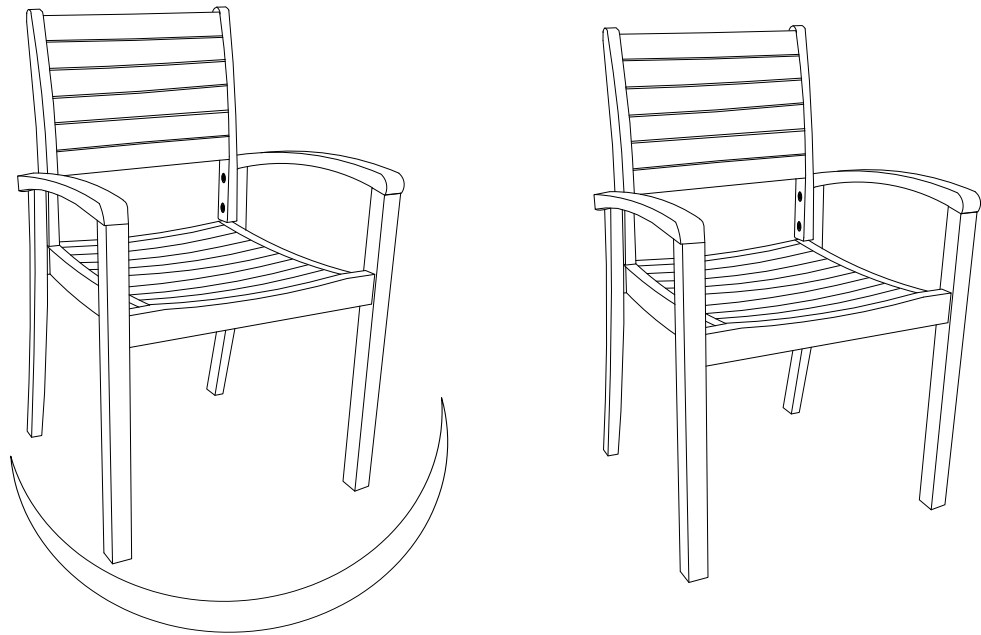

Place the Chair on a **LEVEL SURFACE**.

Gently and gracefully, sit into to the Chair.

This pressure will help the Chair reach full alignment at all joints.

In a sequential manner, gradually tighten all Bolts until evenly secured.

When tightening the Bolts tighten sequentially.

DO NOT tighten any Bolt fully and then move on towards the next one.

If there are still wobbles, loosen the Bolts and execute this same process.

Your Chair is ready for use.

This Chair can only be used on a flat, level surface.



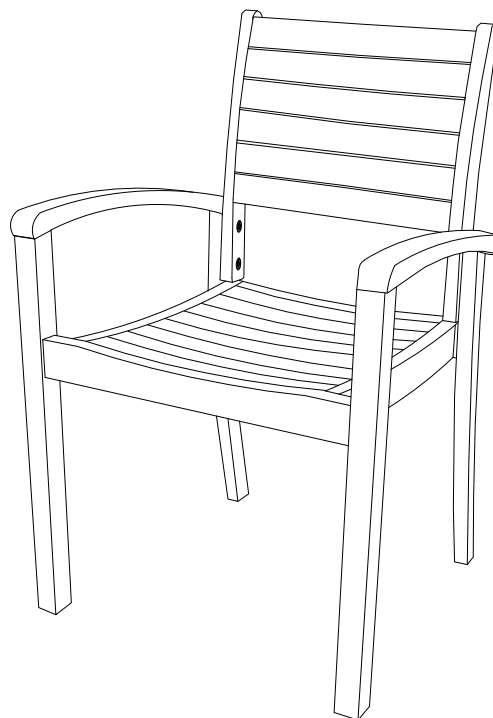





Step 4



The Chair is ready to use now.

Caution: This Chair can only be used on a flat, level surface

Care & Maintenance

-  Do not put hot items directly on furniture surface.
-  Do not clean furniture with harsh cleansers or polish.
-  To obtain the longest lifespan of your outdoor products, minimizing exposure to direct sunlight is recommended.
-  Children should not climb or jump the furniture.
-  Do not write on furniture without a padded barrier to protect the surface.
-  To obtain the longest lifespan of your outdoor products, avoid extended and lengthy exposure to rain, snow, and direct sunshine. whenever possible cover the product and/or place under patio or awnings.
-  Not for commercial use. For residential use only.
-  Stains may be removed with mild soap solution and damp cloth.
-  Dust and pick-up spills using a clean, non-colored, lint-free cloth.