

Assembly Instructions

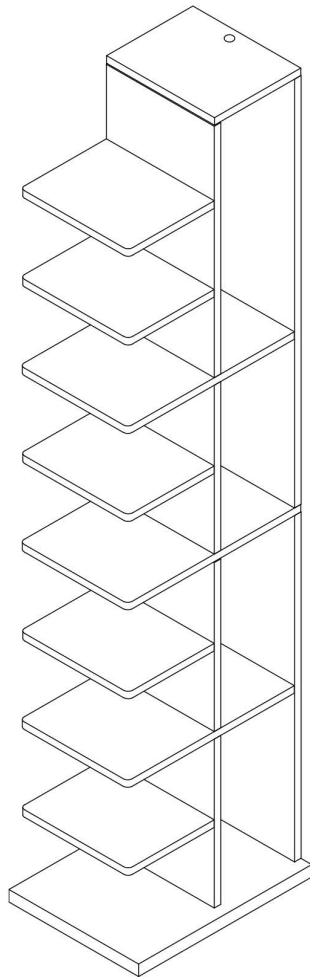

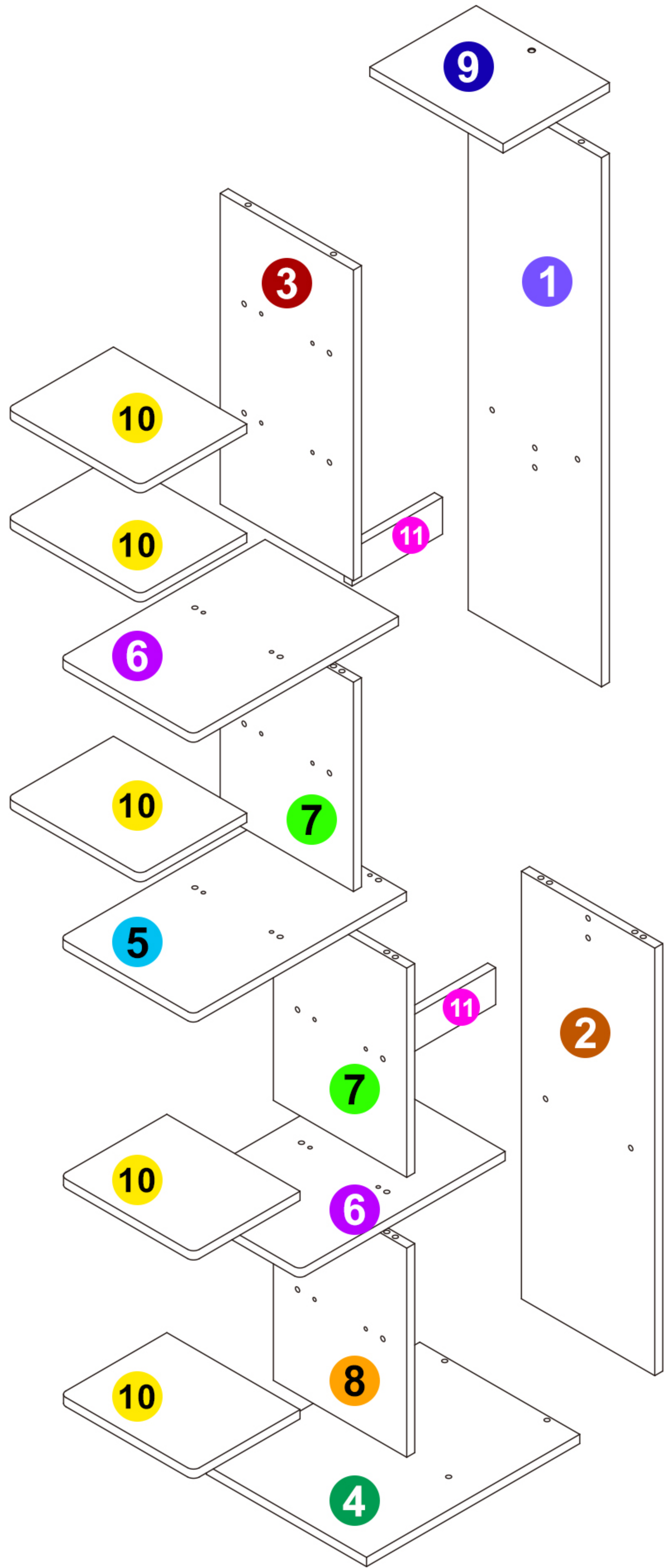

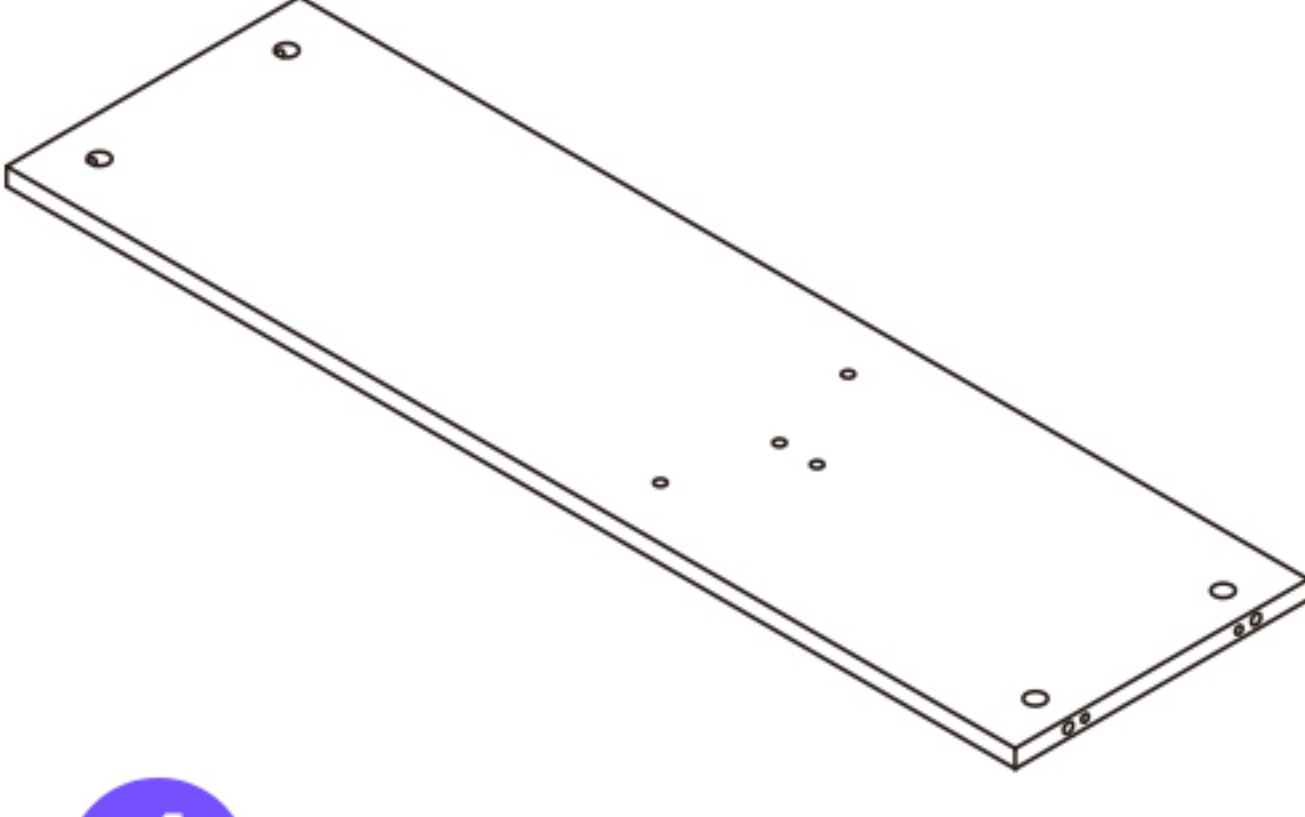

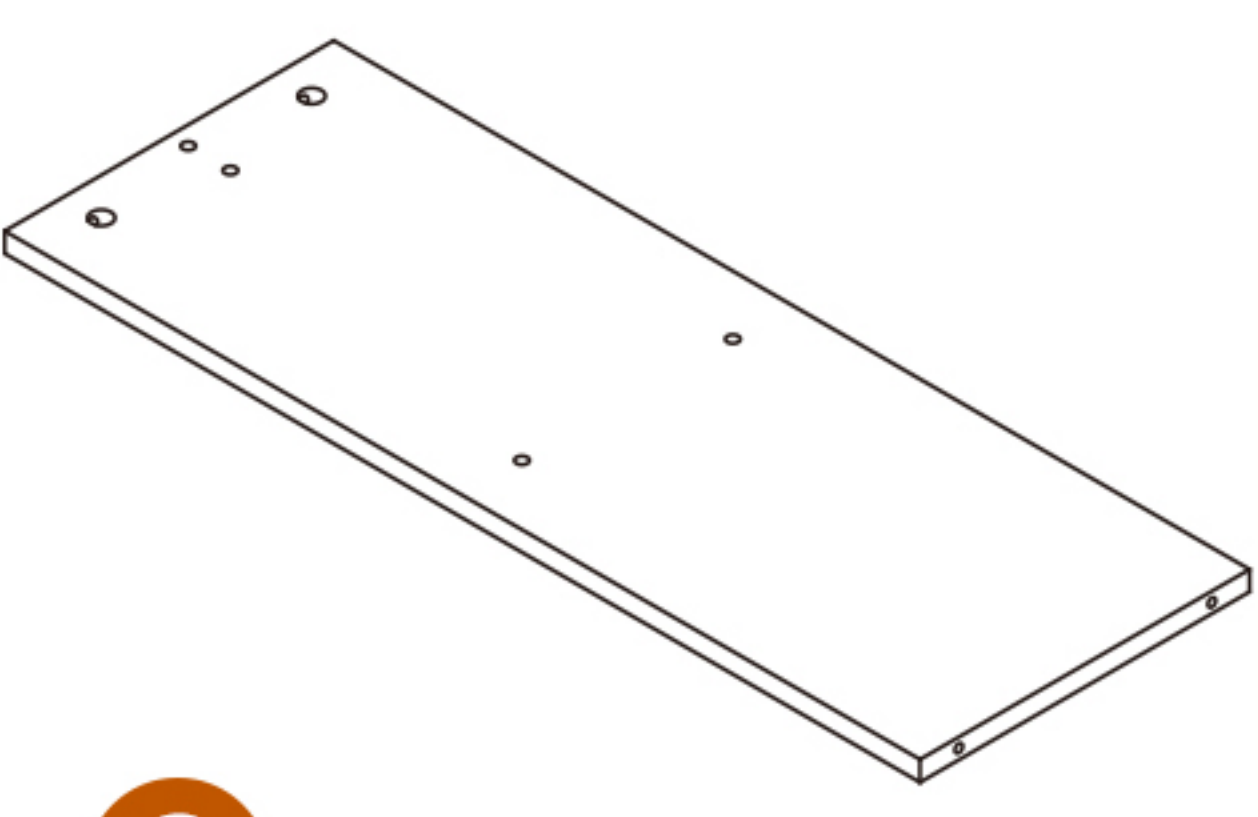
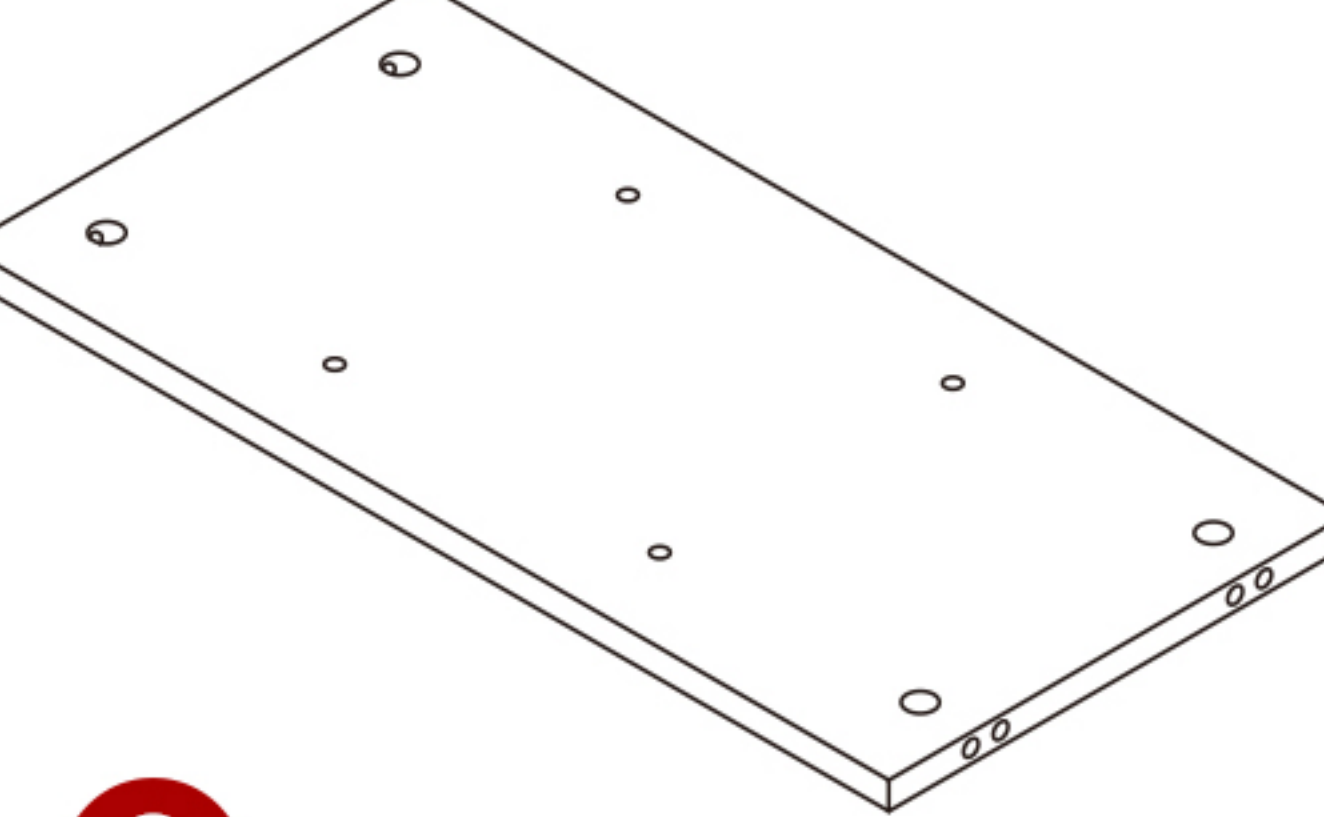
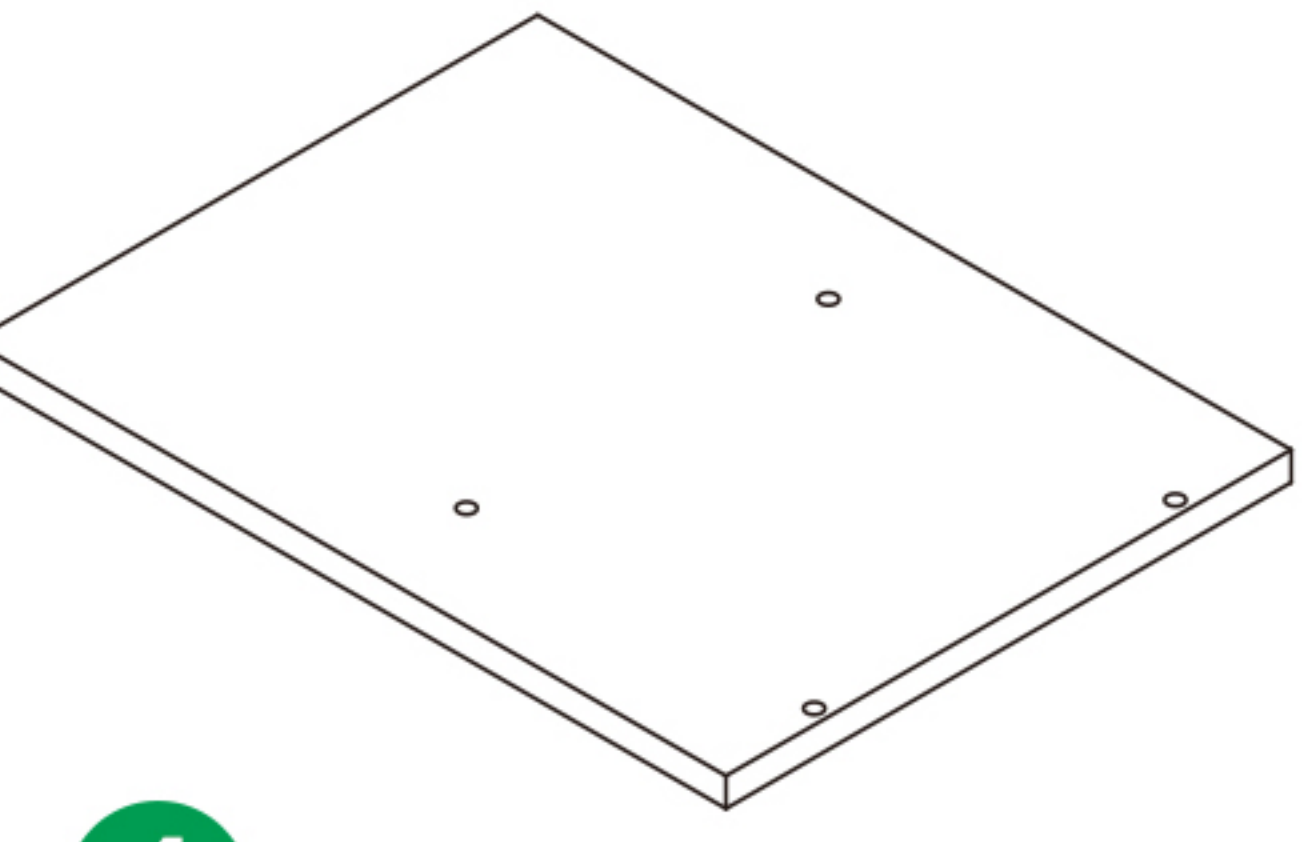
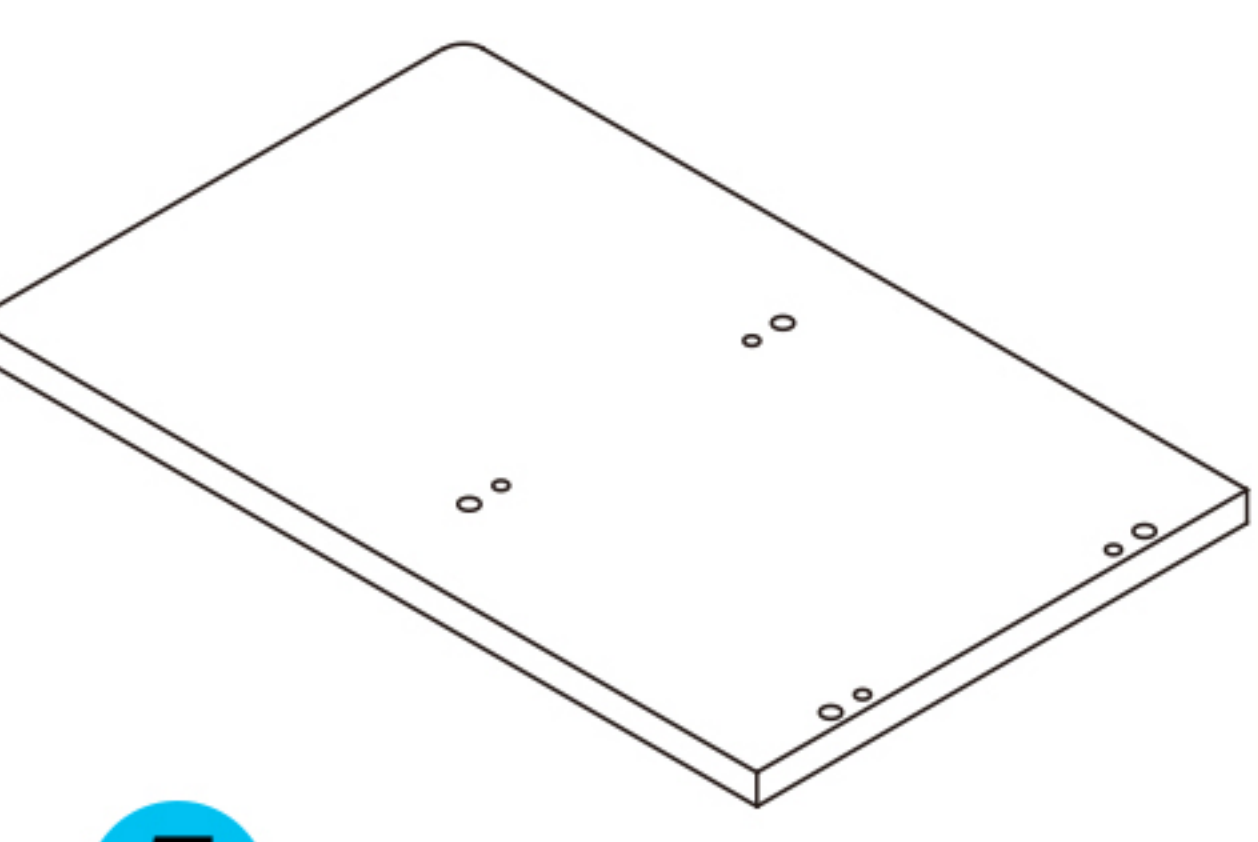
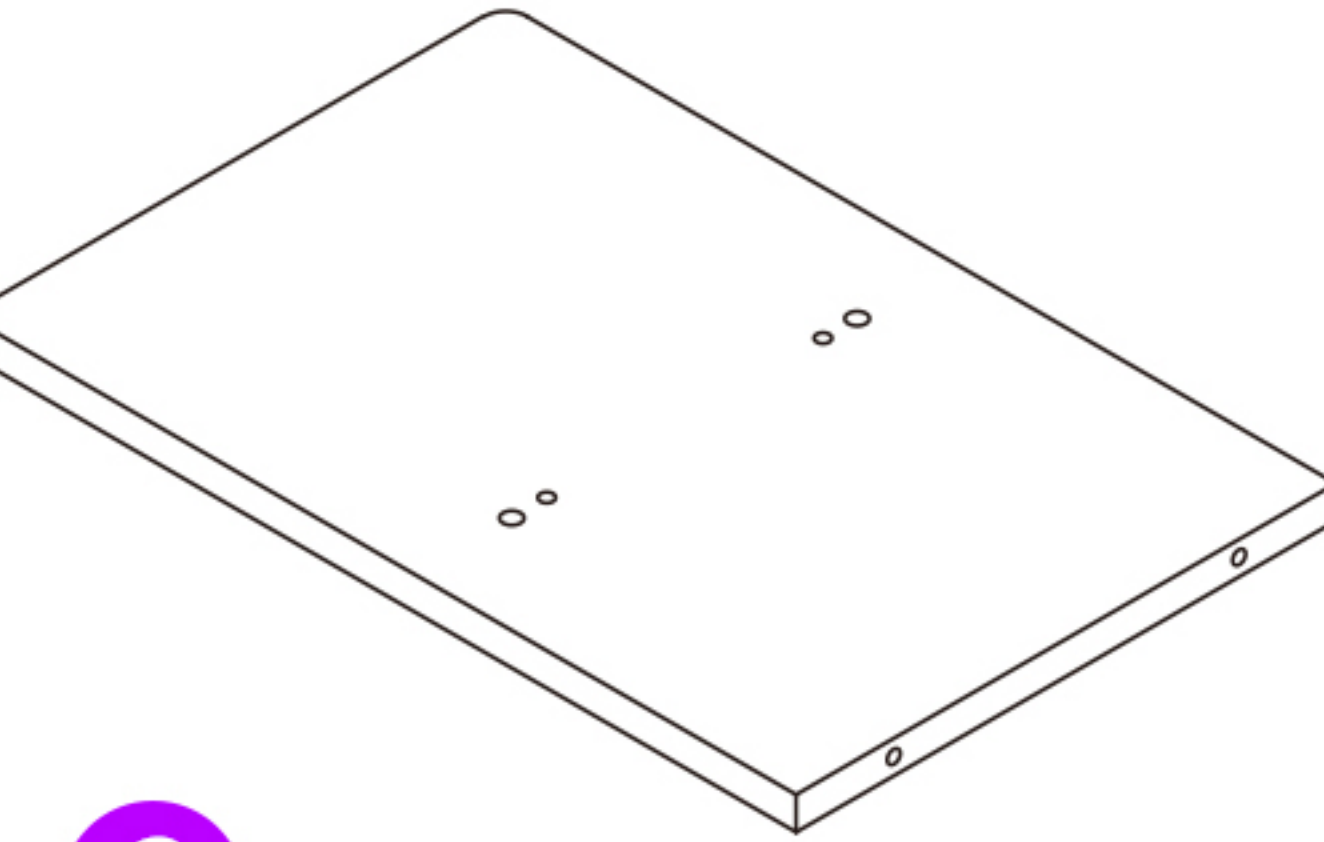
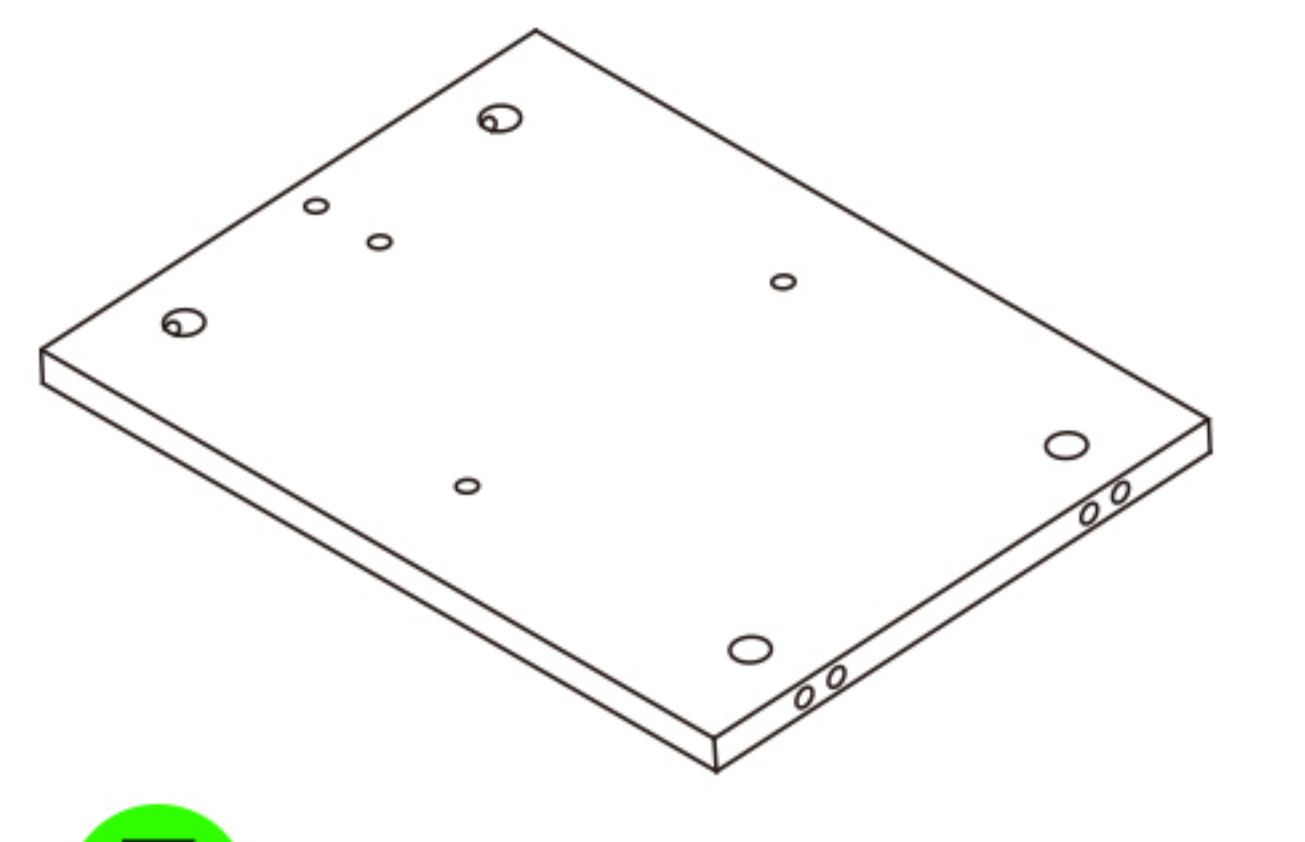
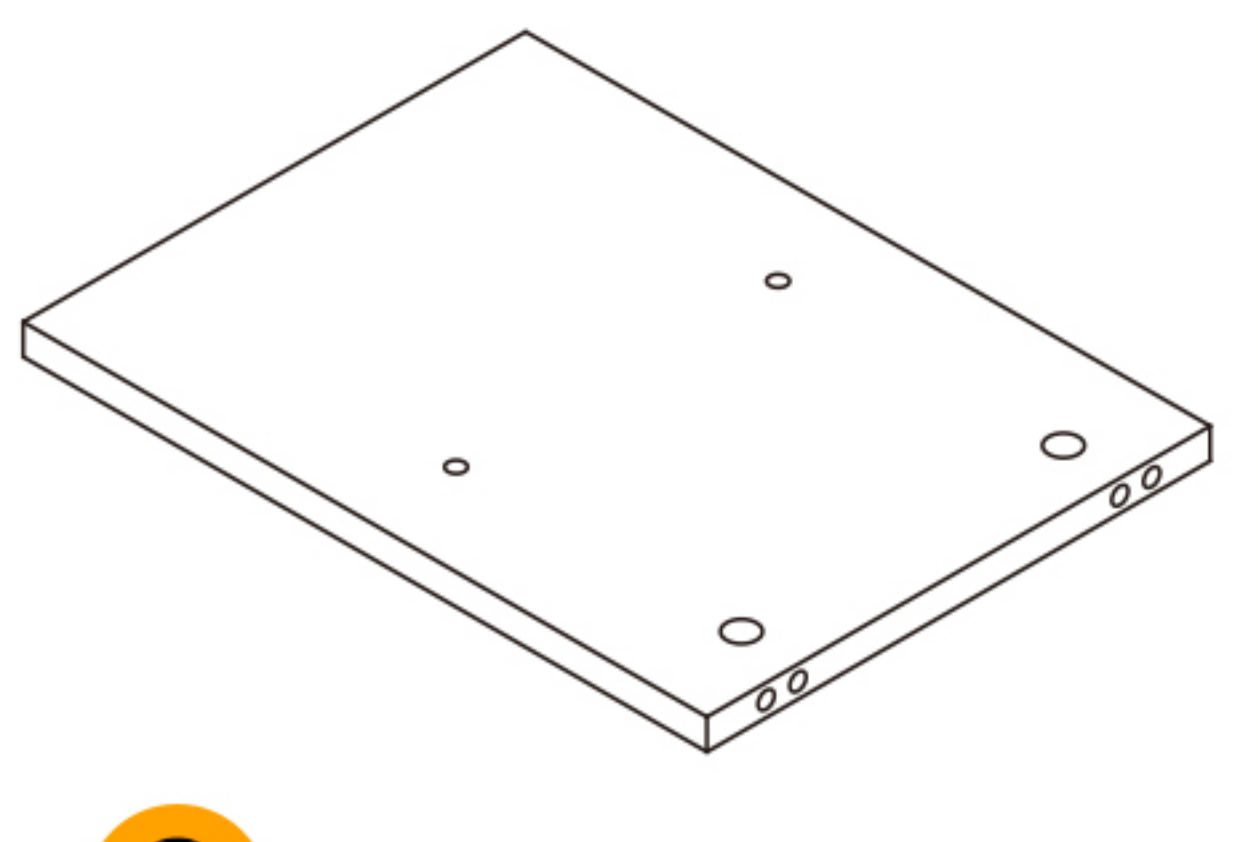
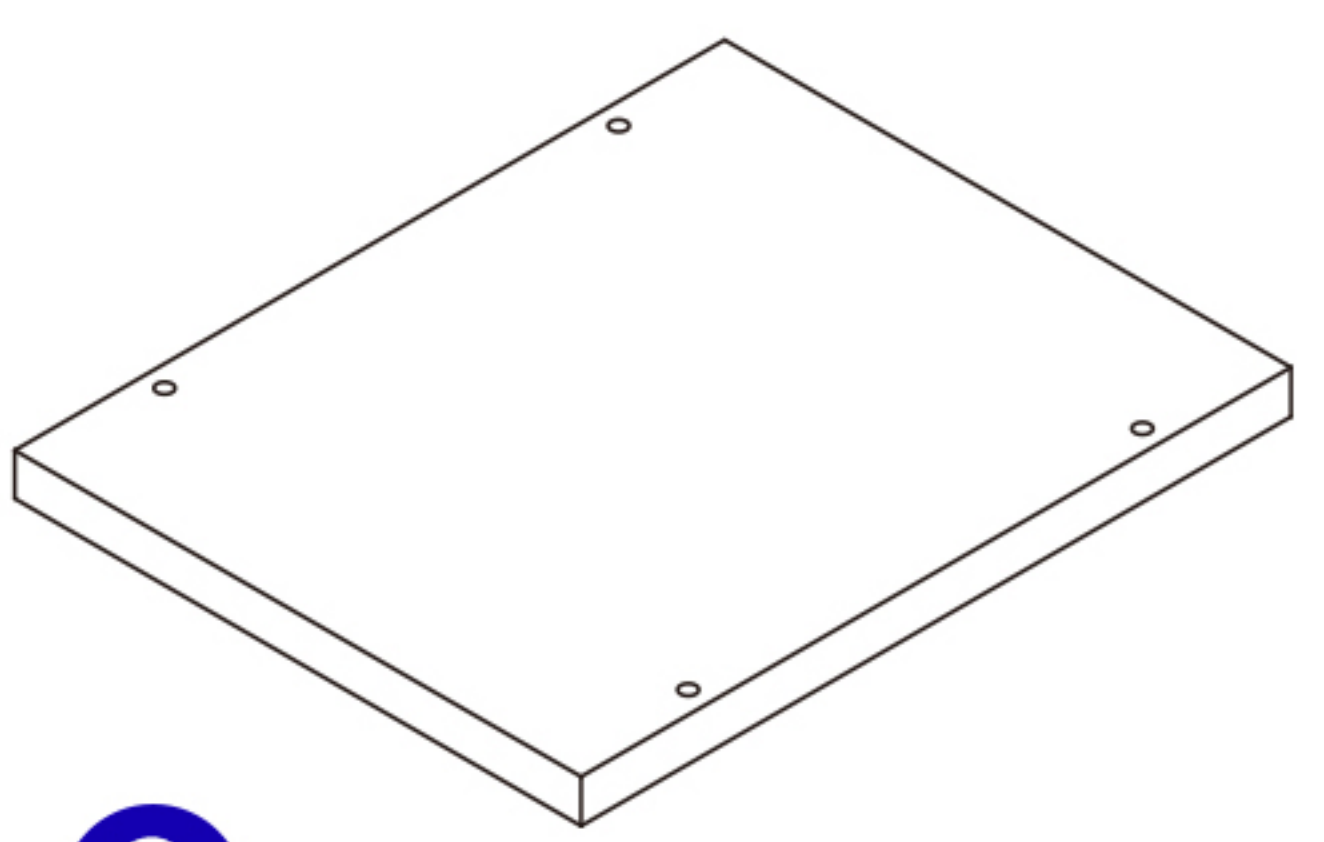
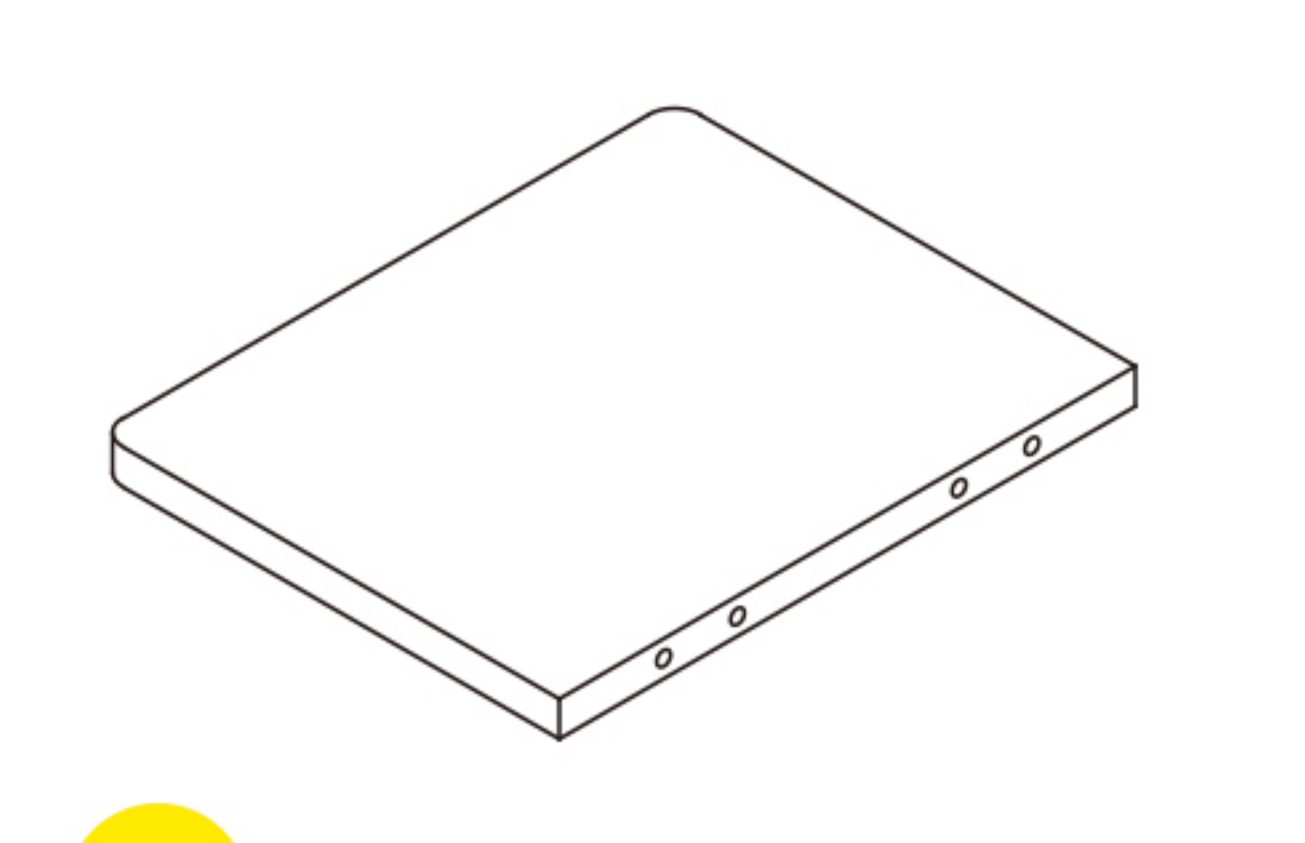
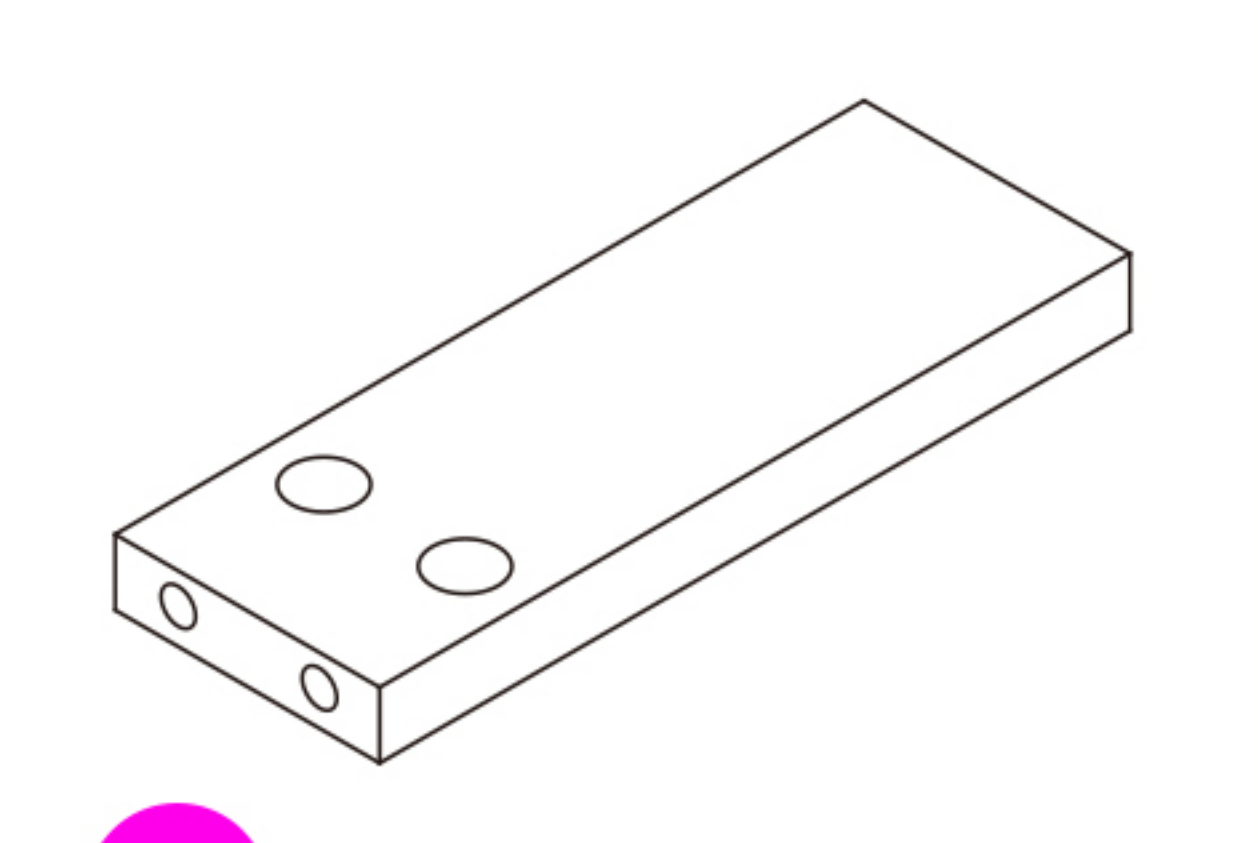



Overall Structure Diagram of the Shelf

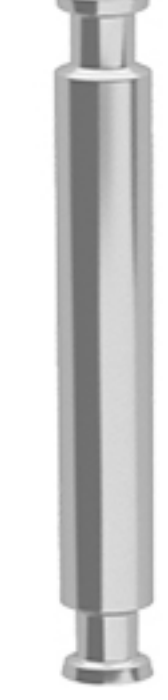

 1 1 pc	 2 1 pc	 3 1 pc
 4 1 pc	 5 1 pc	 6 2 pcs
 7 2 pcs	 8 1 pc	 9 1 pc
 10 5 pcs	 11 2 pcs	

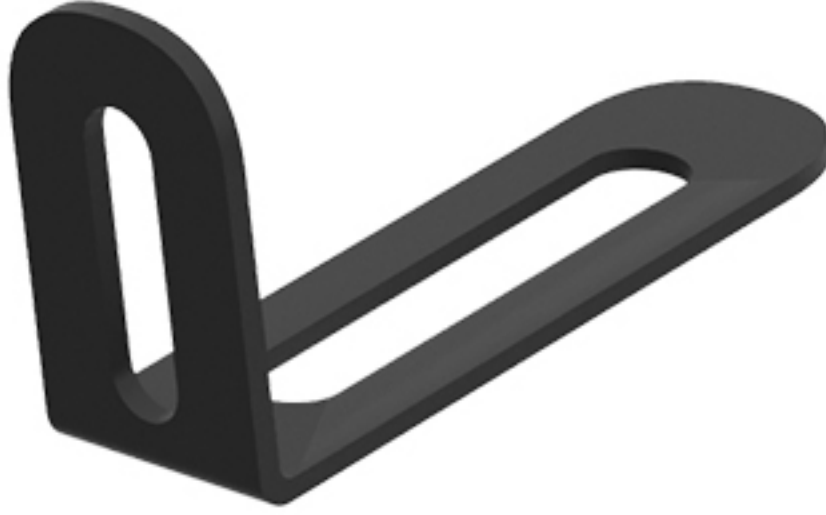
Parts & Hardware List

A  8 pcs	B  M7×50MM 22 pcs	C  24 pcs	D  ∅6×30MM 26 pcs	E  ∅5.02×68MM 8 pcs
X  1 SET	Y  Anti-slip mats 4 pcs	Z  Anti-tip device 1 pc	M  Spare plastic buried component 10 pcs	

Notice: Part M is pre-installed in the panels, an additional 10 pieces are included

Installation of Cams and Pins

1. The sample shown in the manual is in walnut color, but all steps and details apply to other colors as well.
2. For easier and safer assembly, make sure the product is placed flat on the floor until installation is completed.

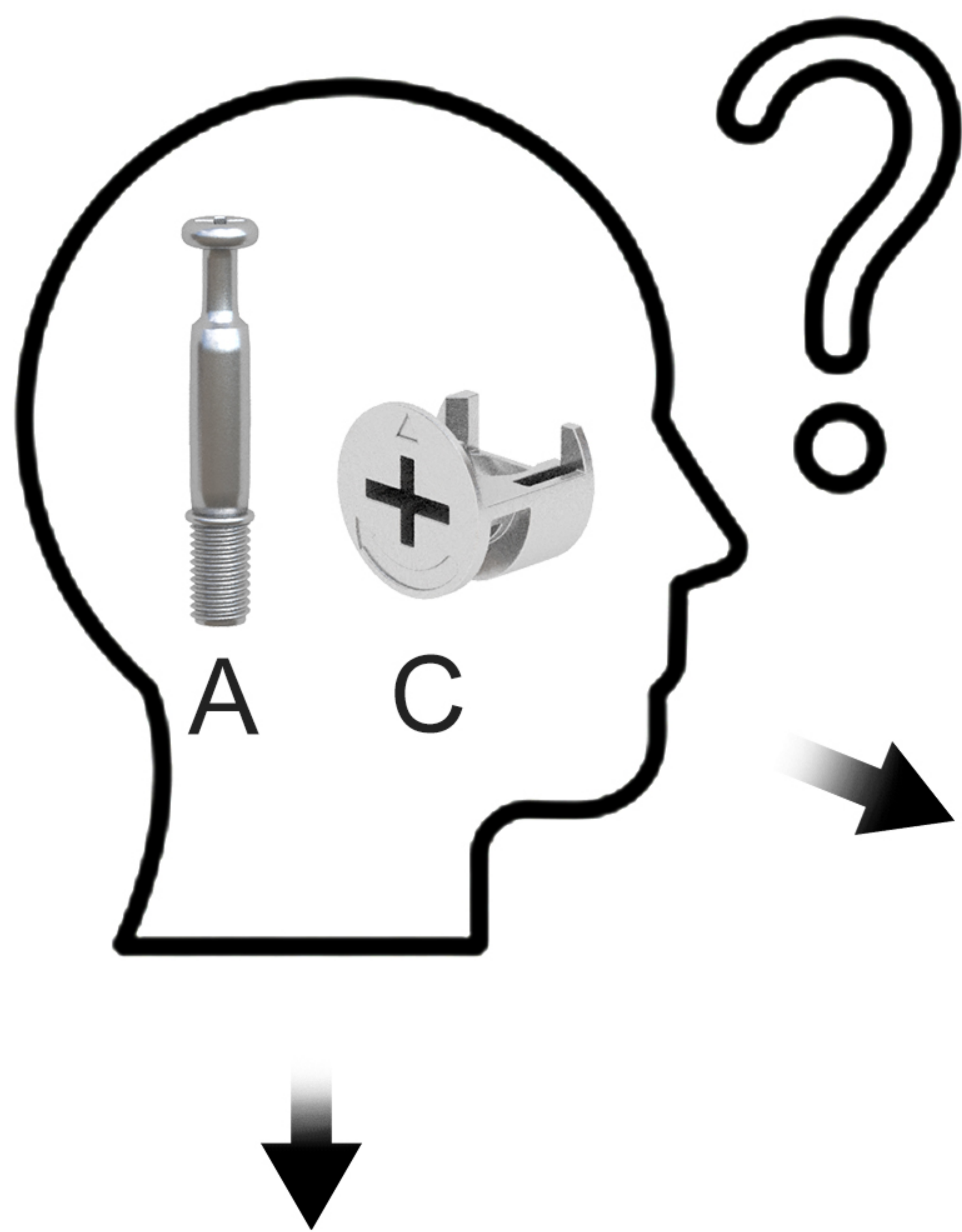

Before installing the product, make sure to carefully watch the screw accessory installation steps on this page.

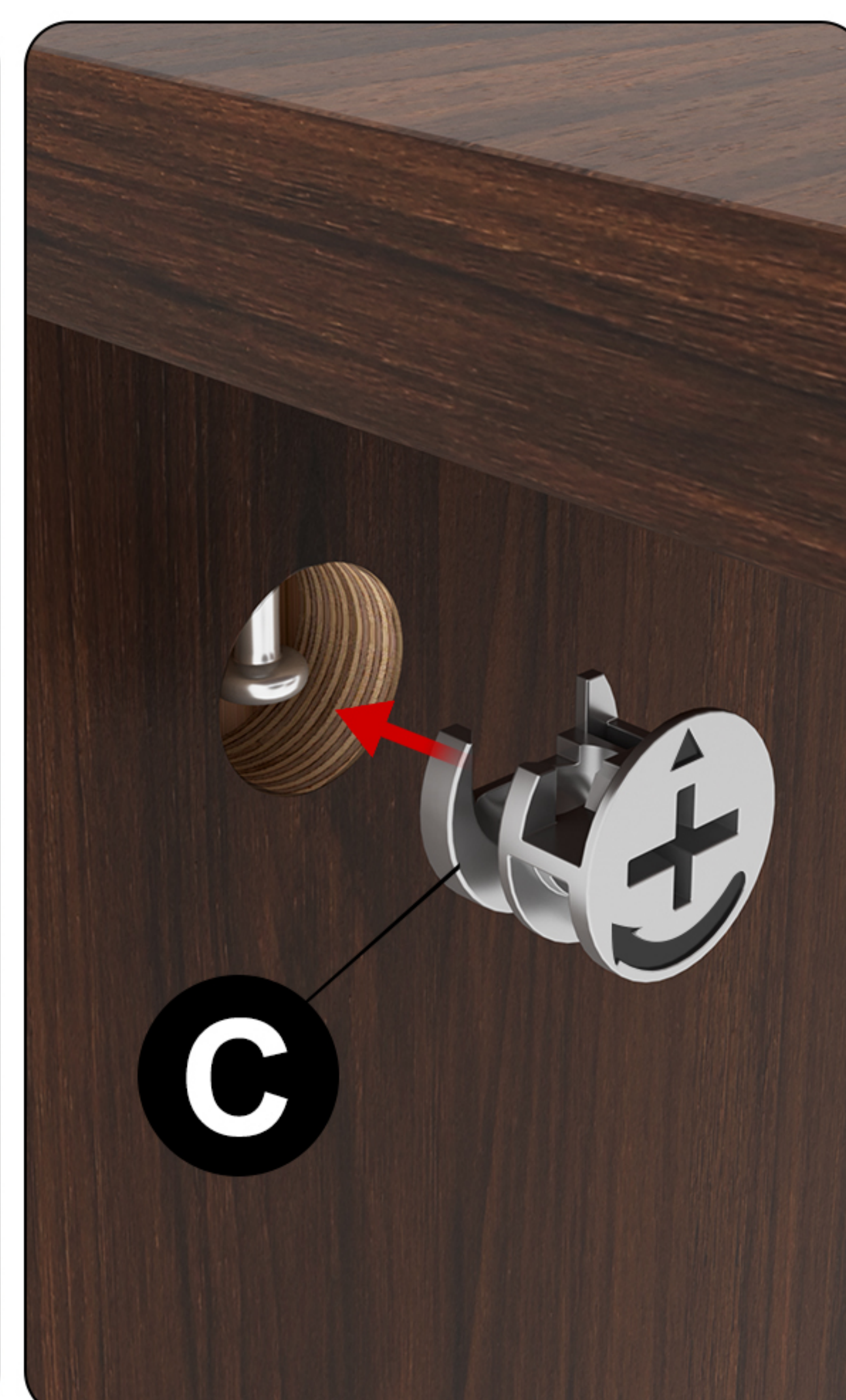
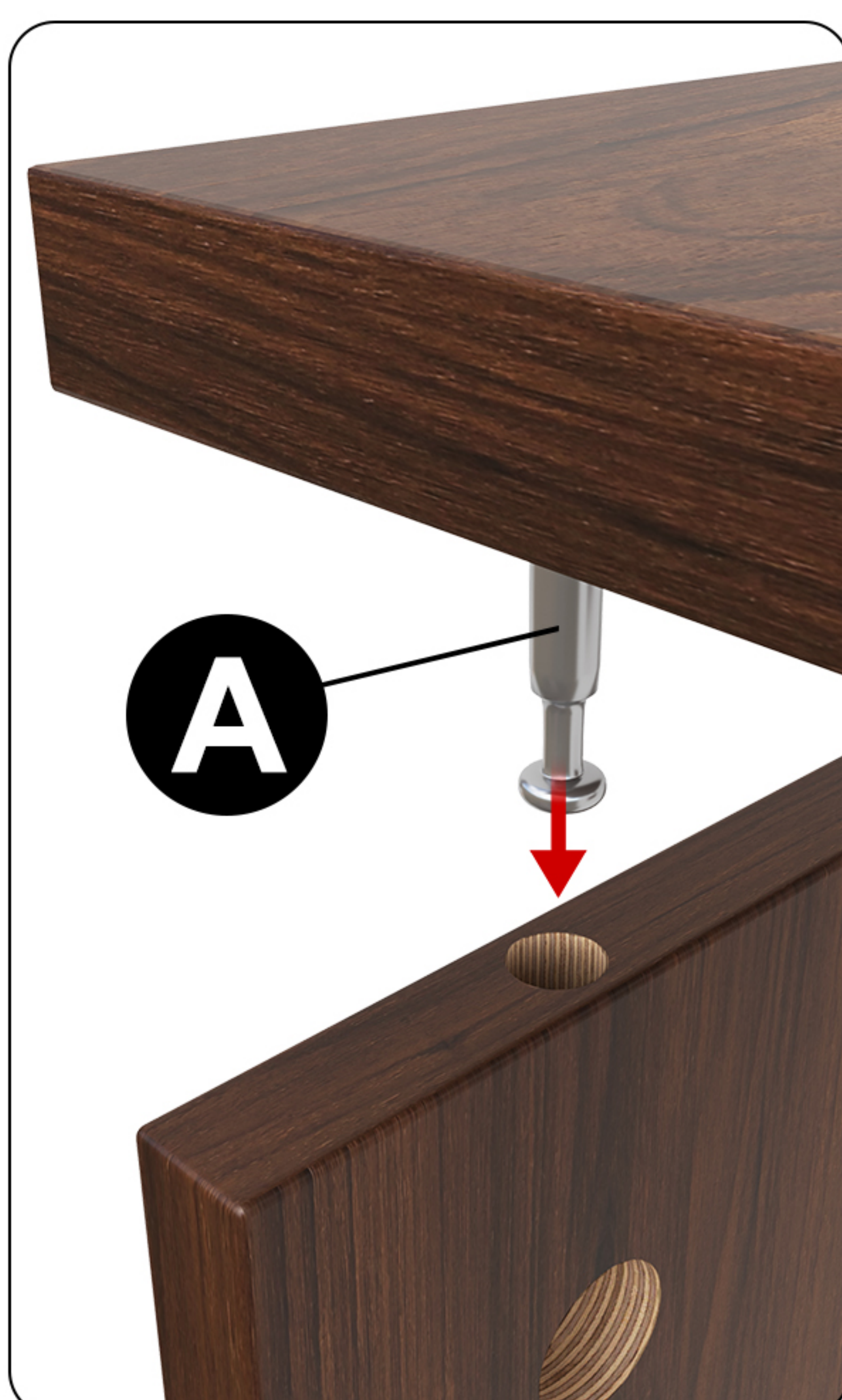
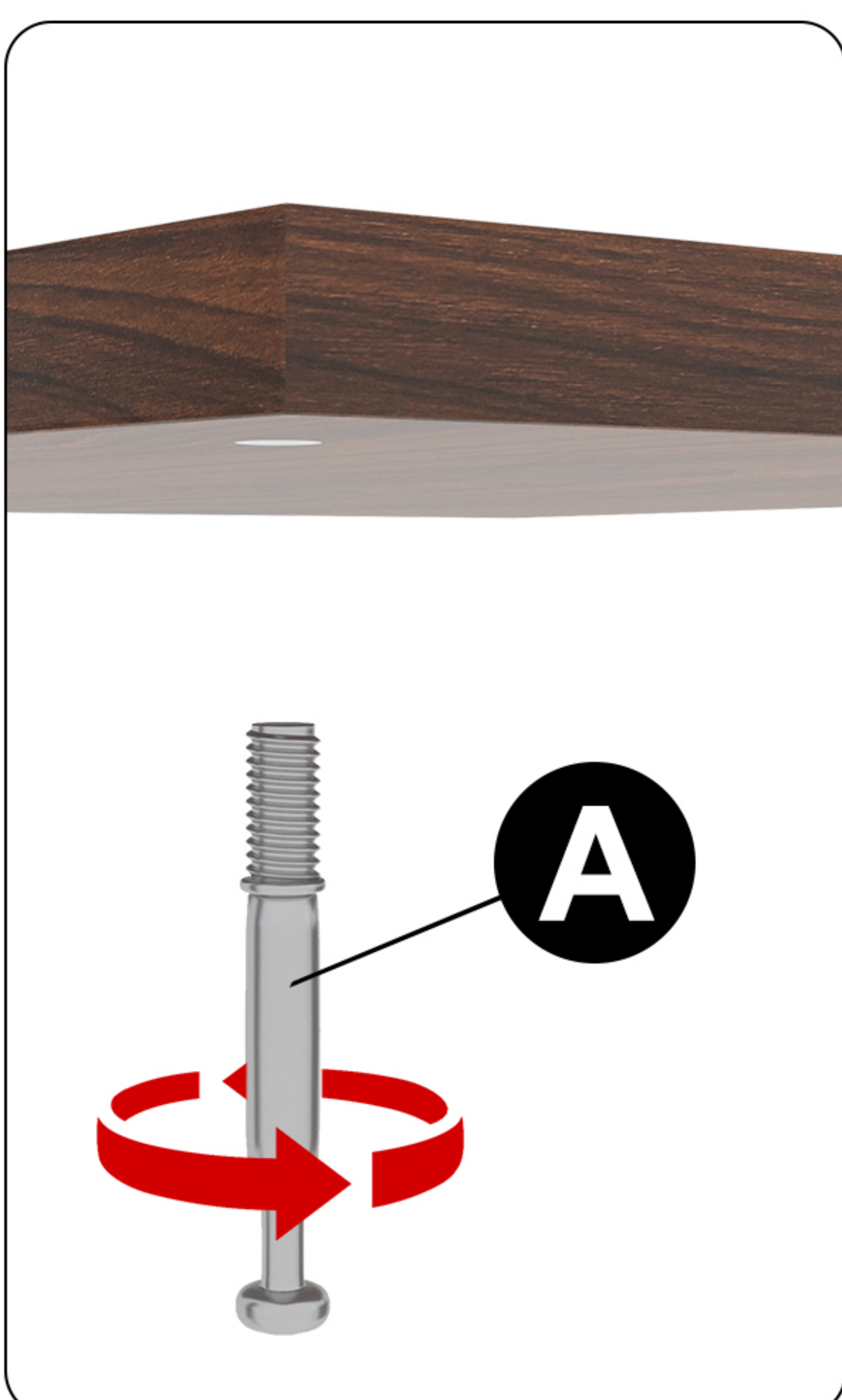
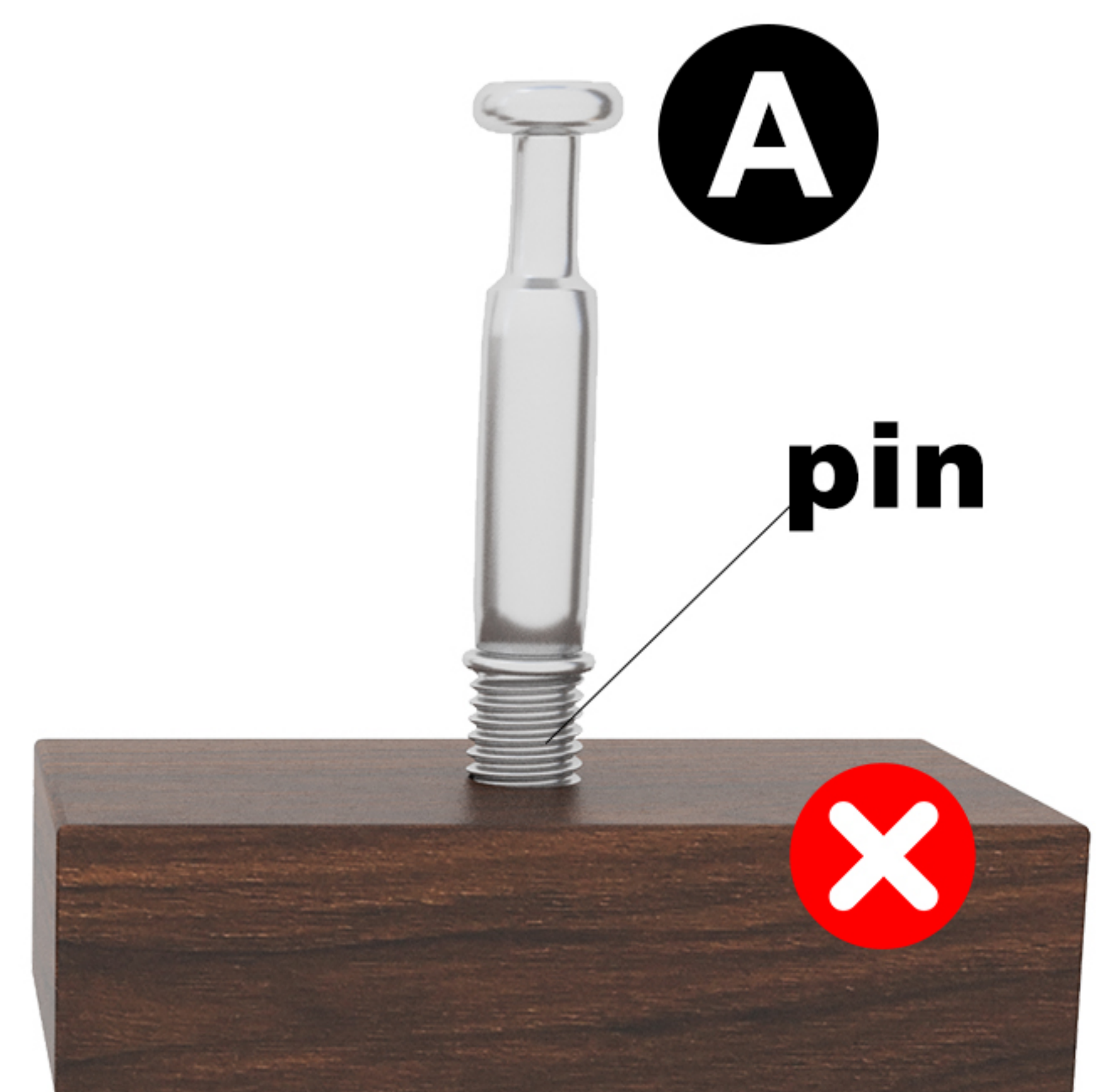
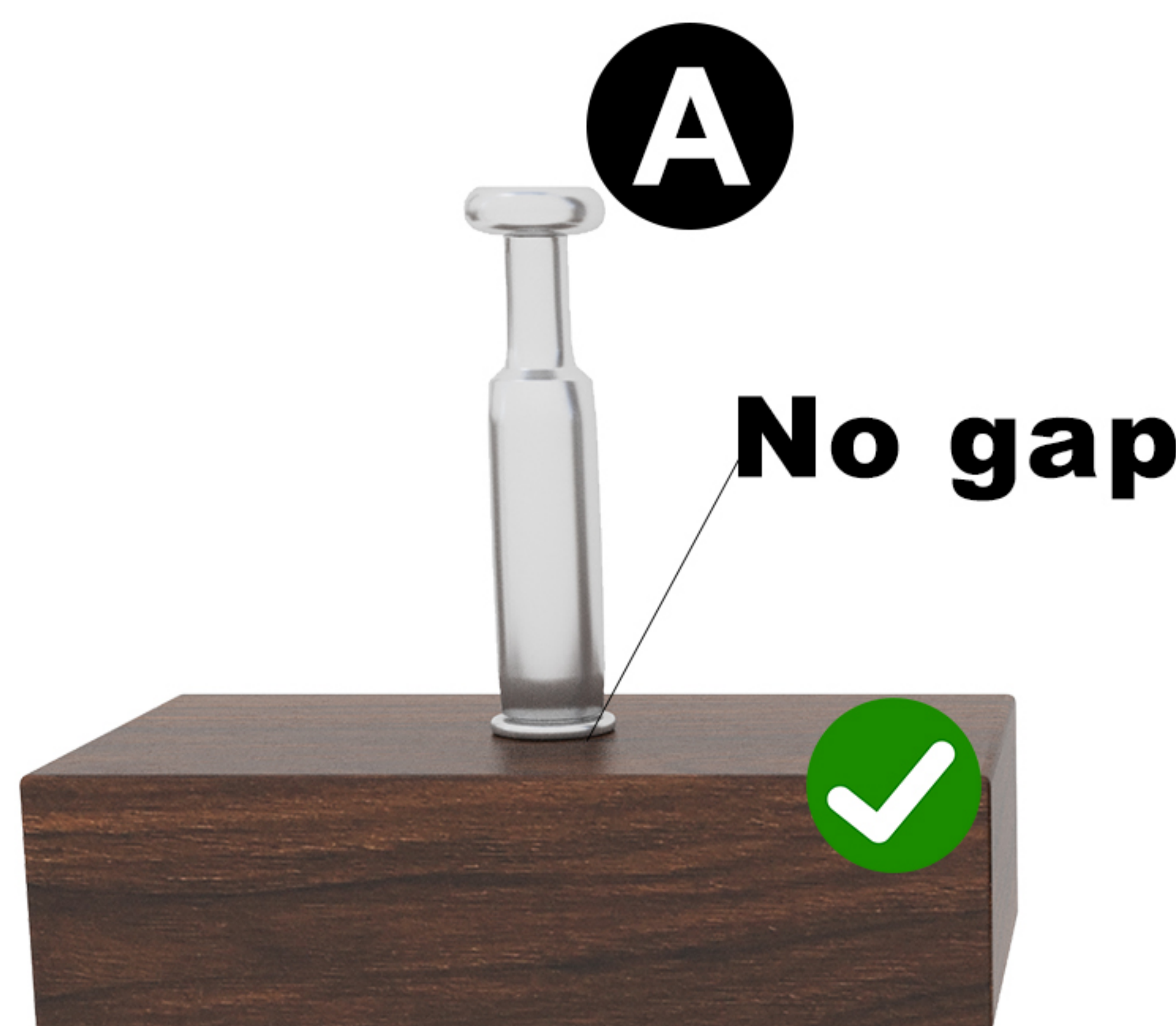

Accessories E and C Usage

STEP 1

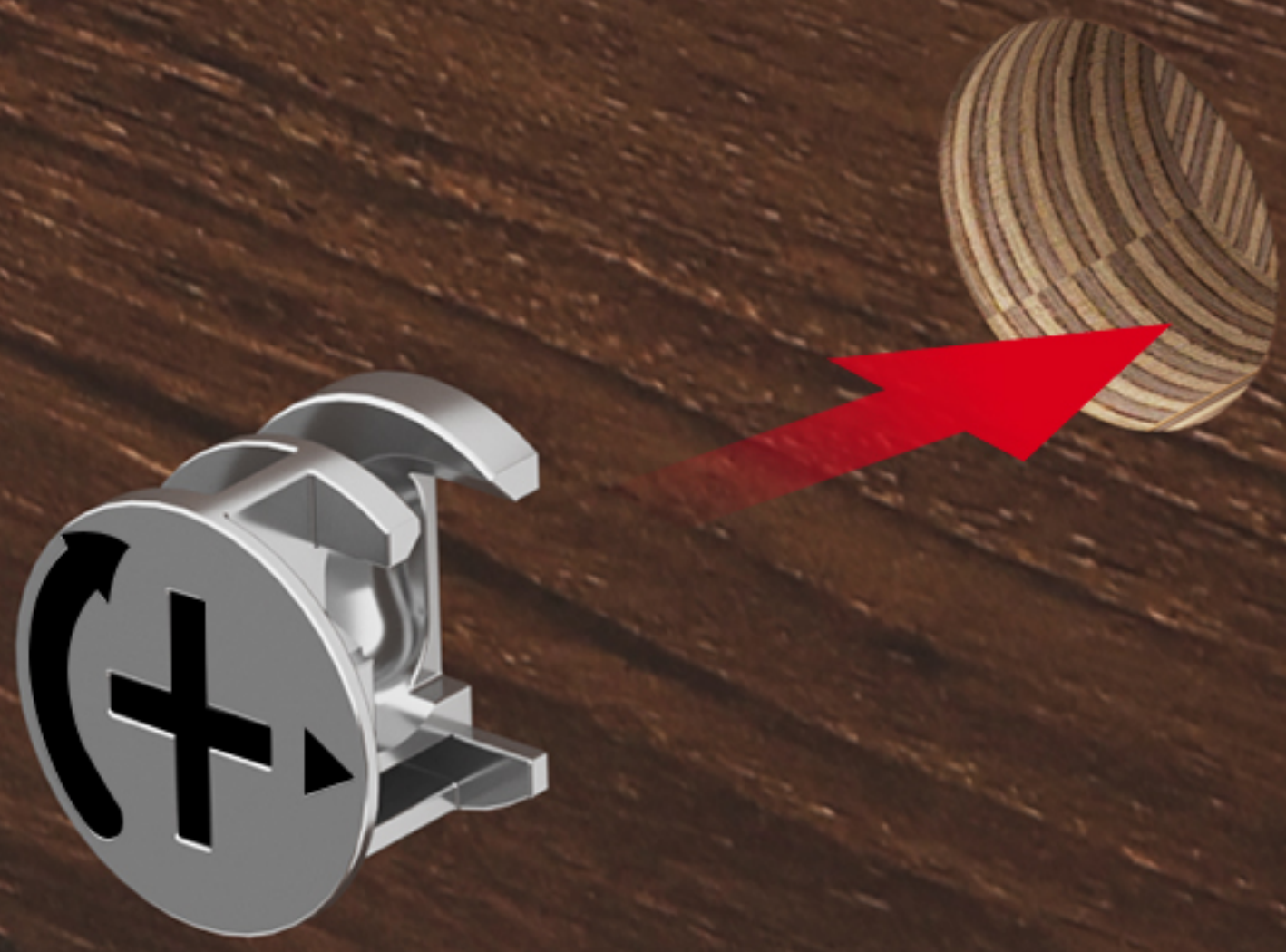

STEP 4



STEP 2



STEP 5



STEP 3



STEP 6



Assembly Steps

Step 1

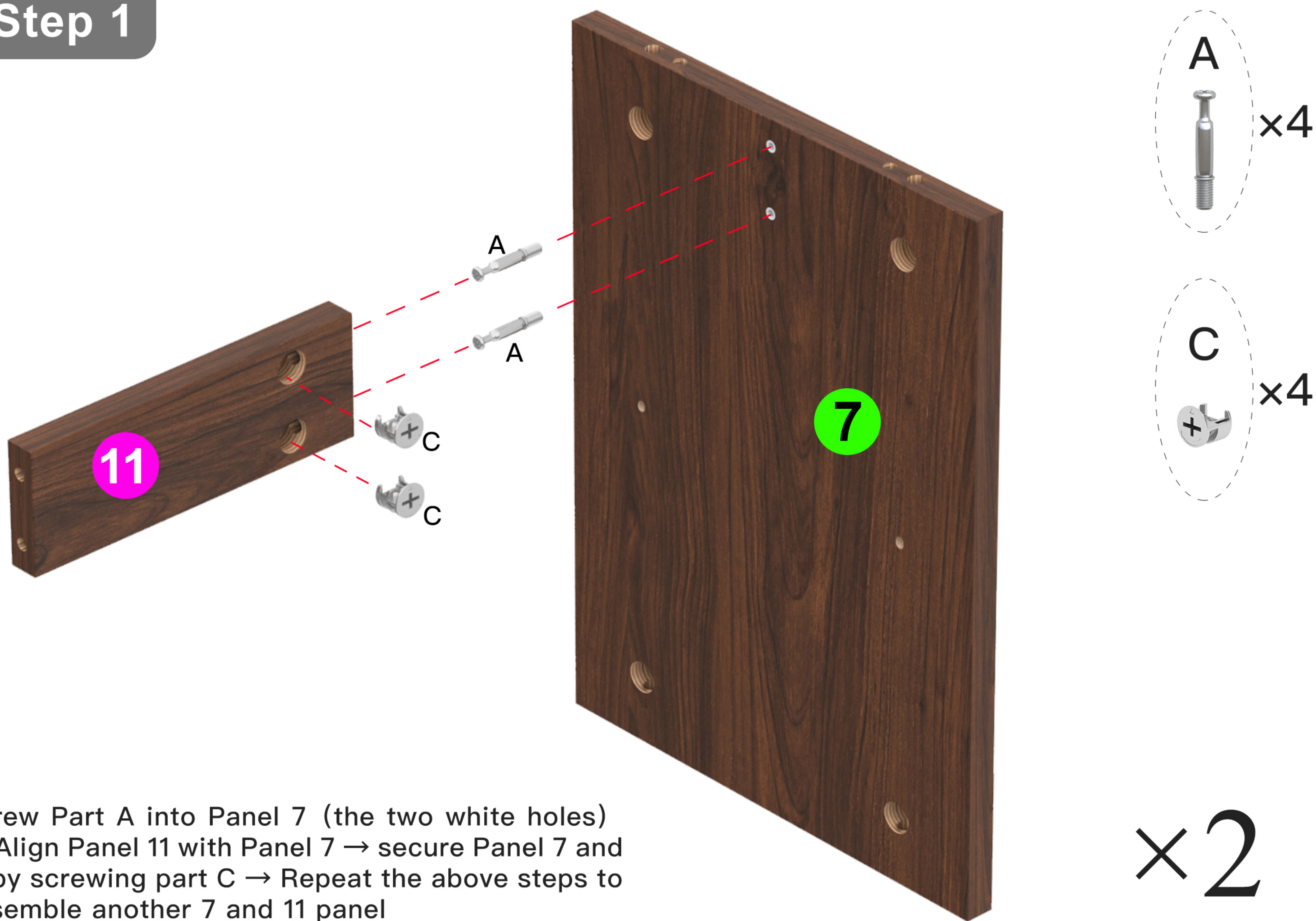

Screw Part A into Panel 7 (the two white holes)
→ Align Panel 11 with Panel 7 → secure Panel 7 and 11 by screwing part C → Repeat the above steps to assemble another 7 and 11 panel

Step 2

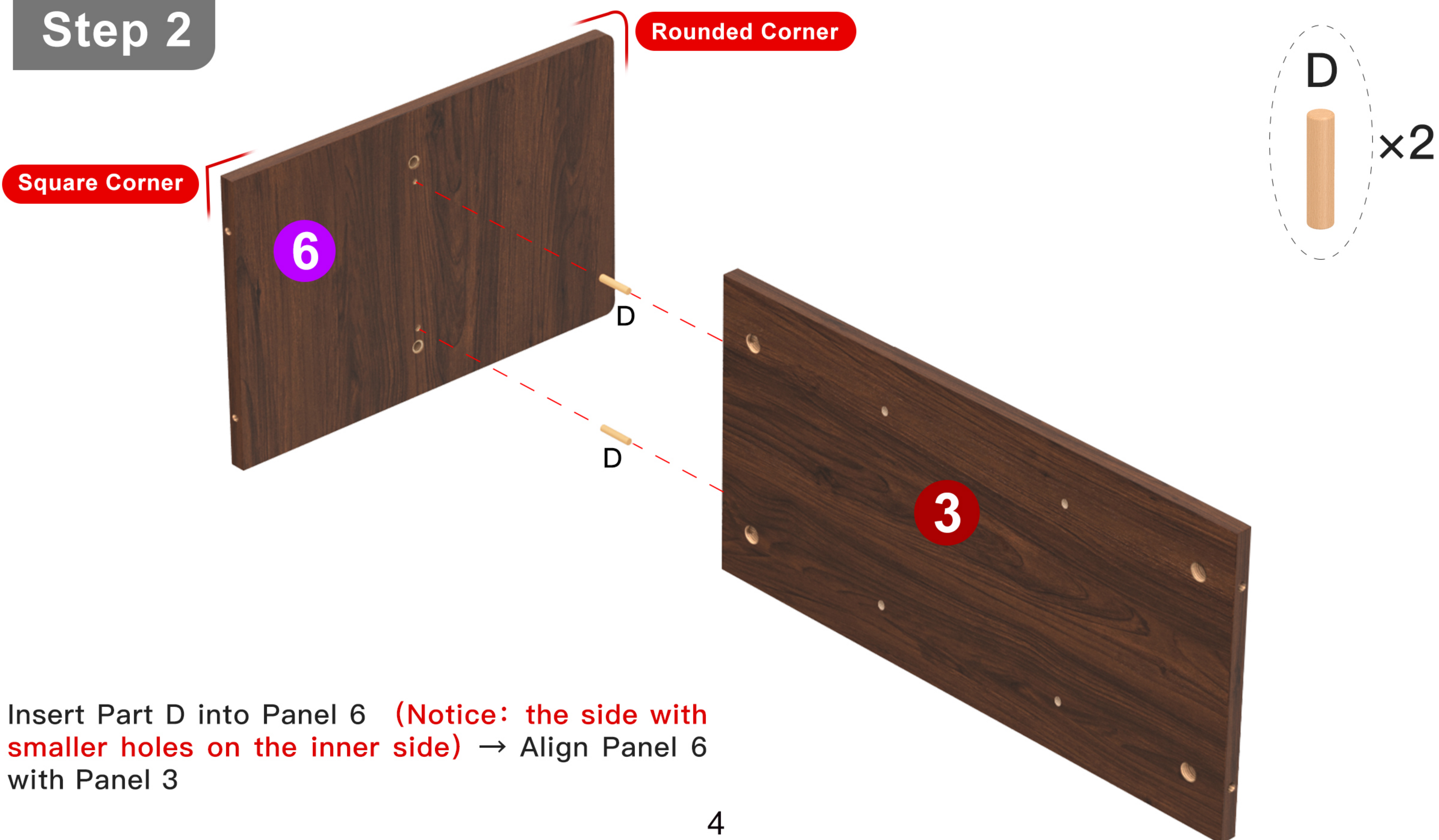

Insert Part D into Panel 6 (Notice: the side with smaller holes on the inner side) → Align Panel 6 with Panel 3

Step 3

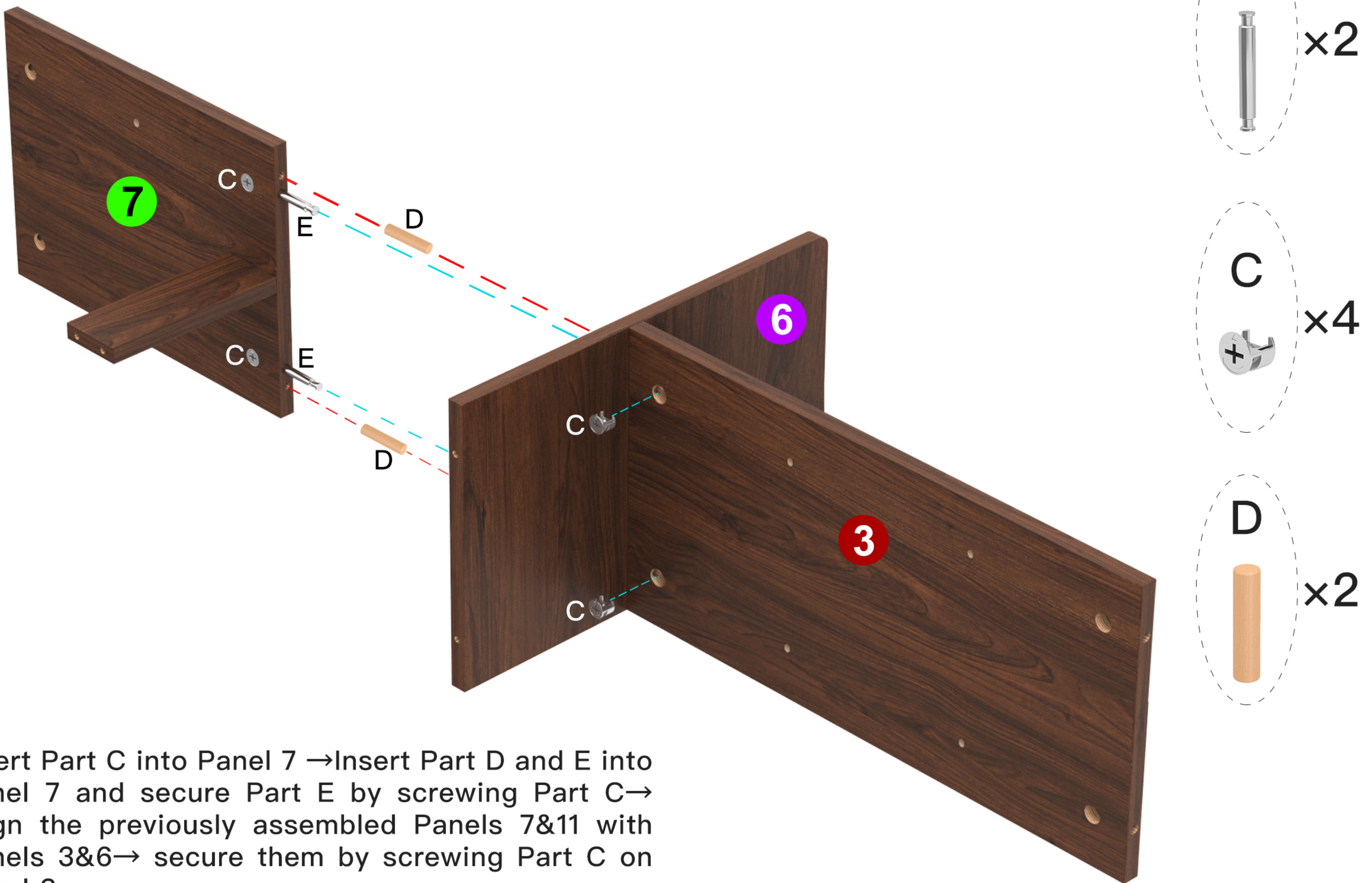

Insert Part C into Panel 7 → Insert Part D and E into Panel 7 and secure Part E by screwing Part C → Align the previously assembled Panels 7&11 with Panels 3&6 → secure them by screwing Part C on Panel 3

Step 4

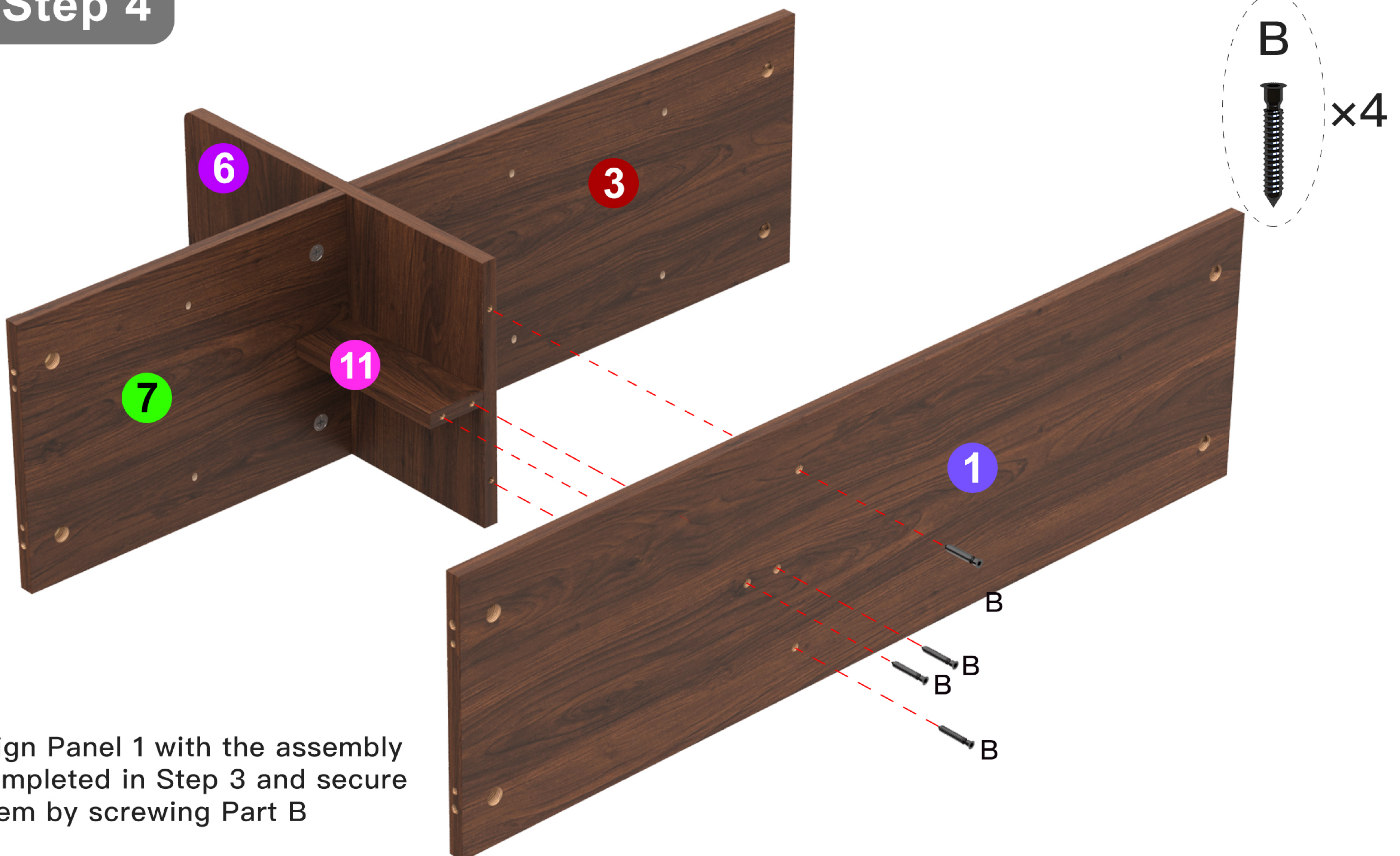

Align Panel 1 with the assembly completed in Step 3 and secure them by screwing Part B

Step 5

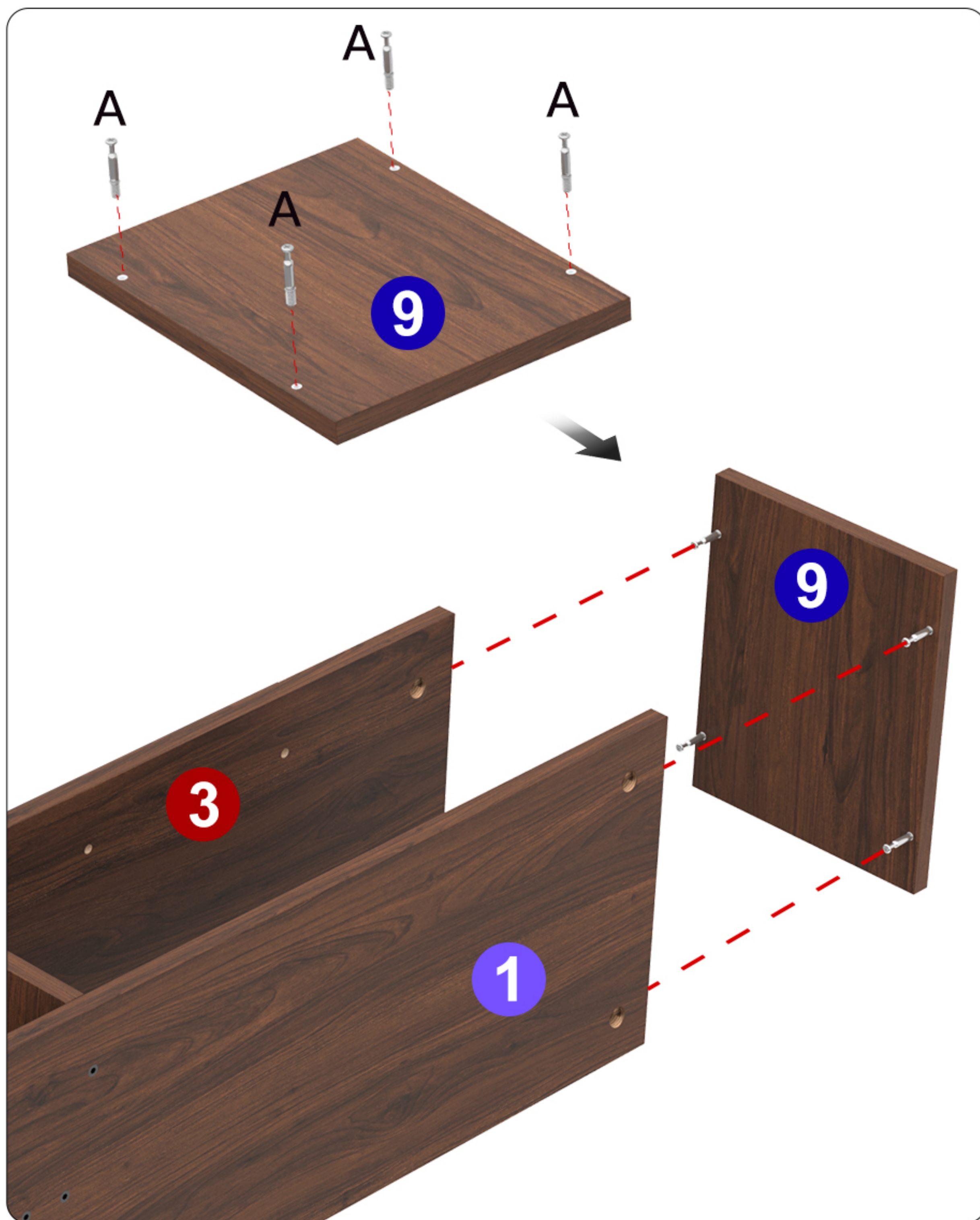

Screw Part A into Panel 9 →
Align Panel 9 with Panel 3 and 1
→ secure them using Part C

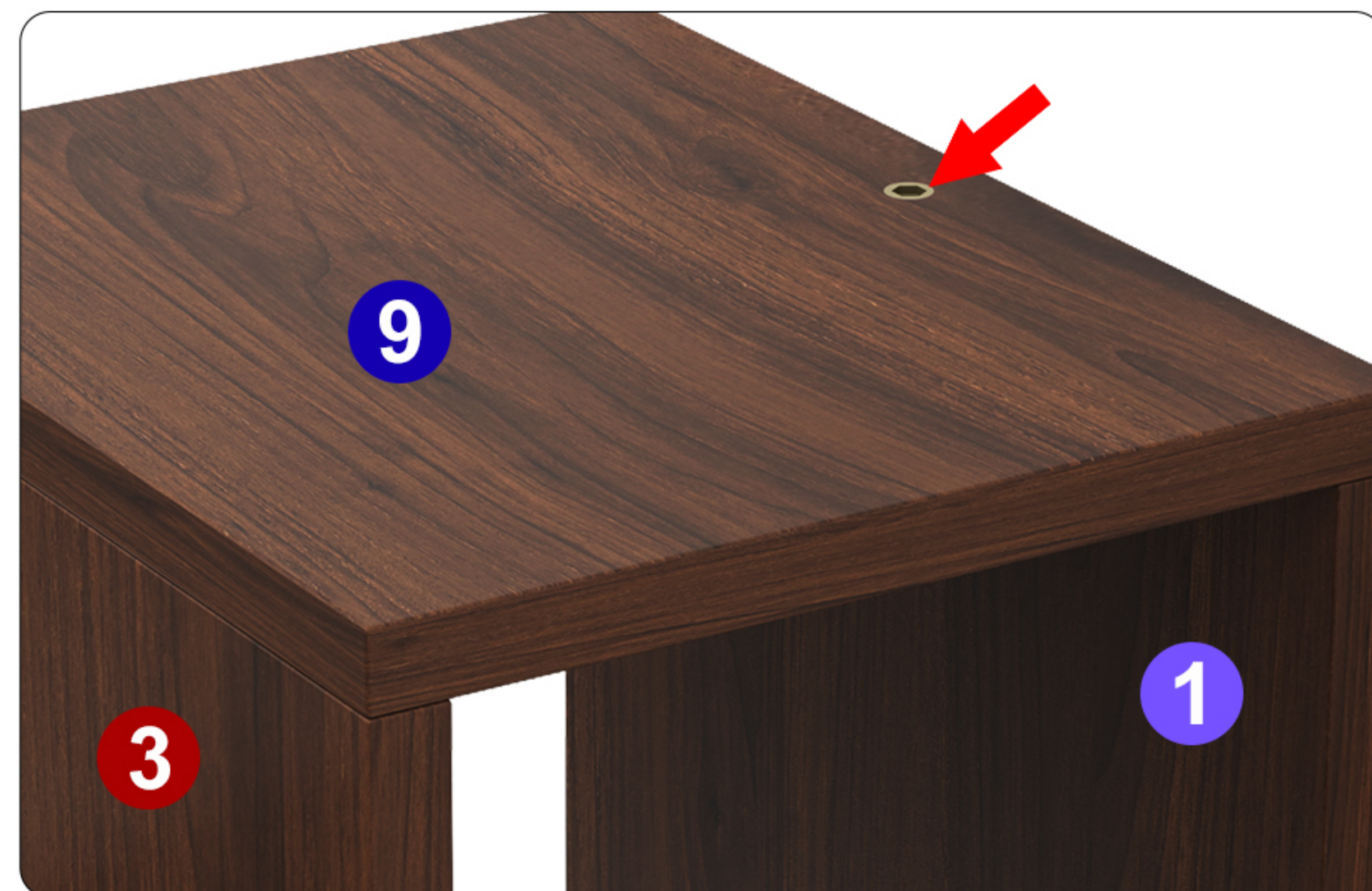
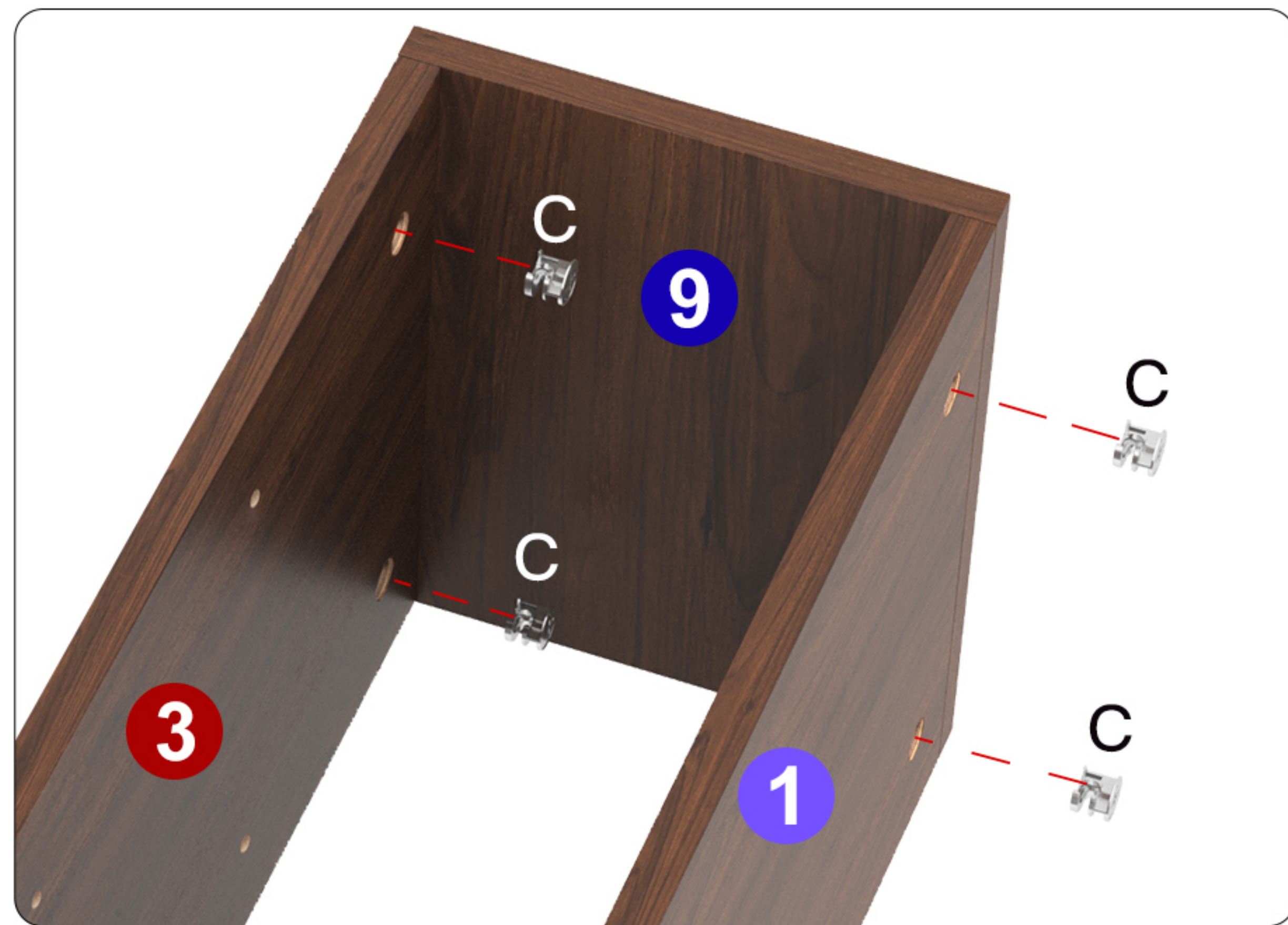

! Make sure the anti-tip mounting hole on Panel 9 is positioned on the side closest to Panel 1

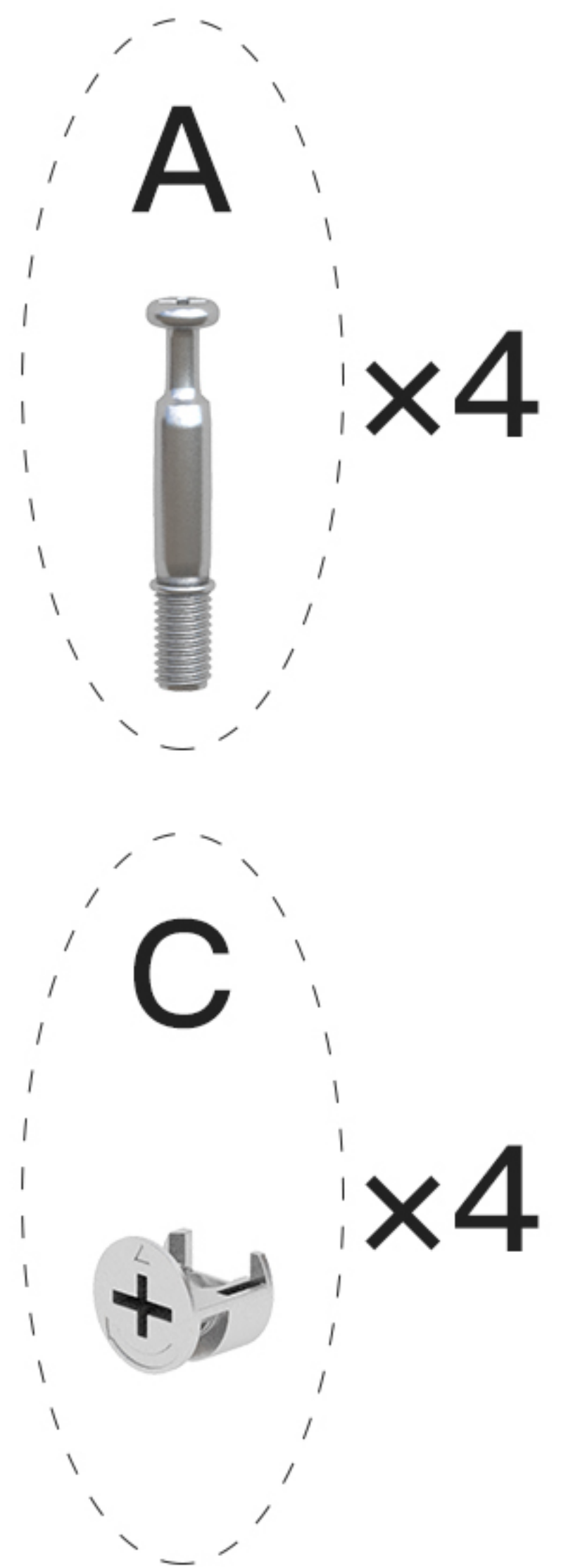

Step 6

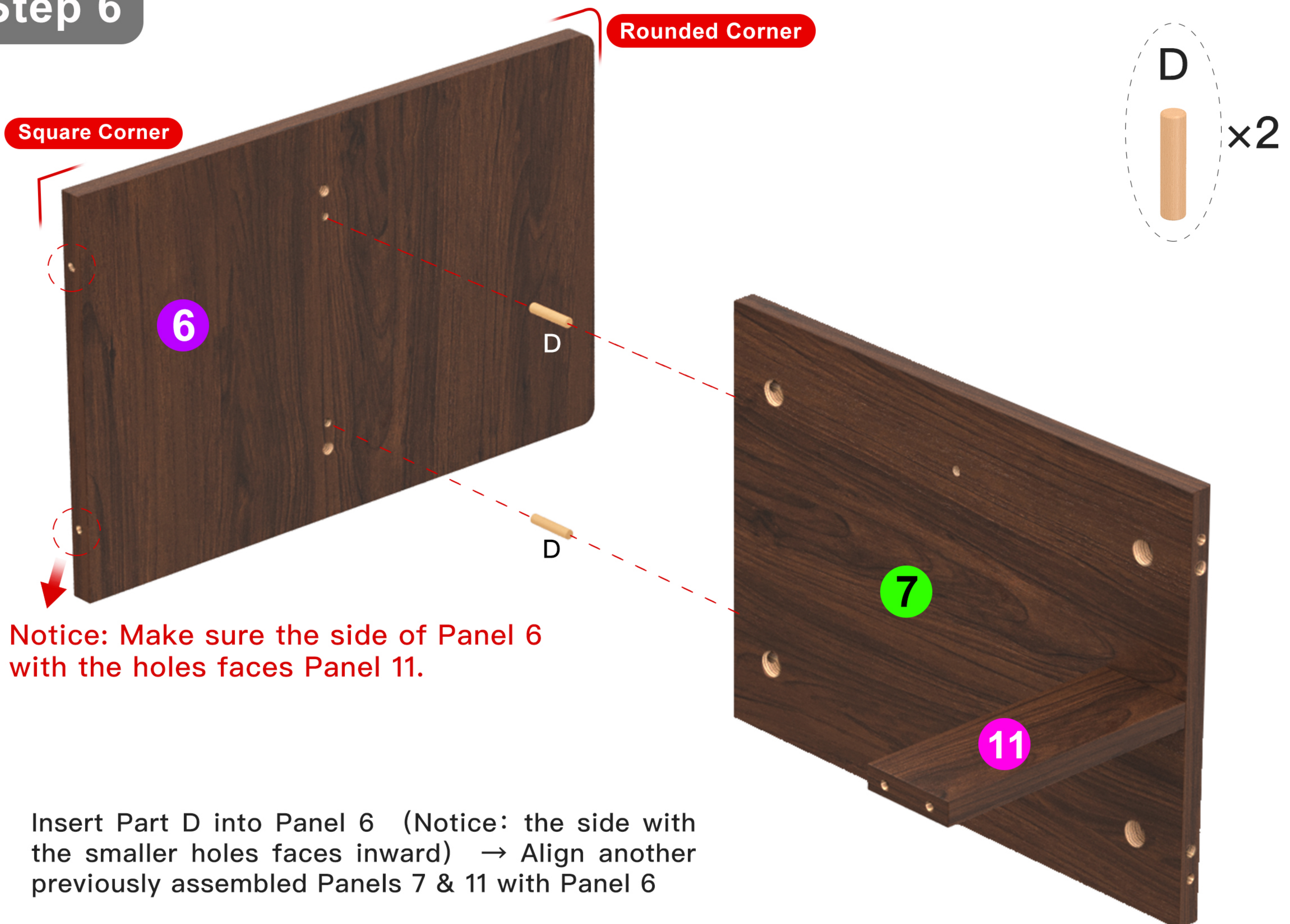

Notice: Make sure the side of Panel 6 with the holes faces Panel 11.

Insert Part D into Panel 6 (Notice: the side with the smaller holes faces inward) → Align another previously assembled Panels 7 & 11 with Panel 6

Step 7

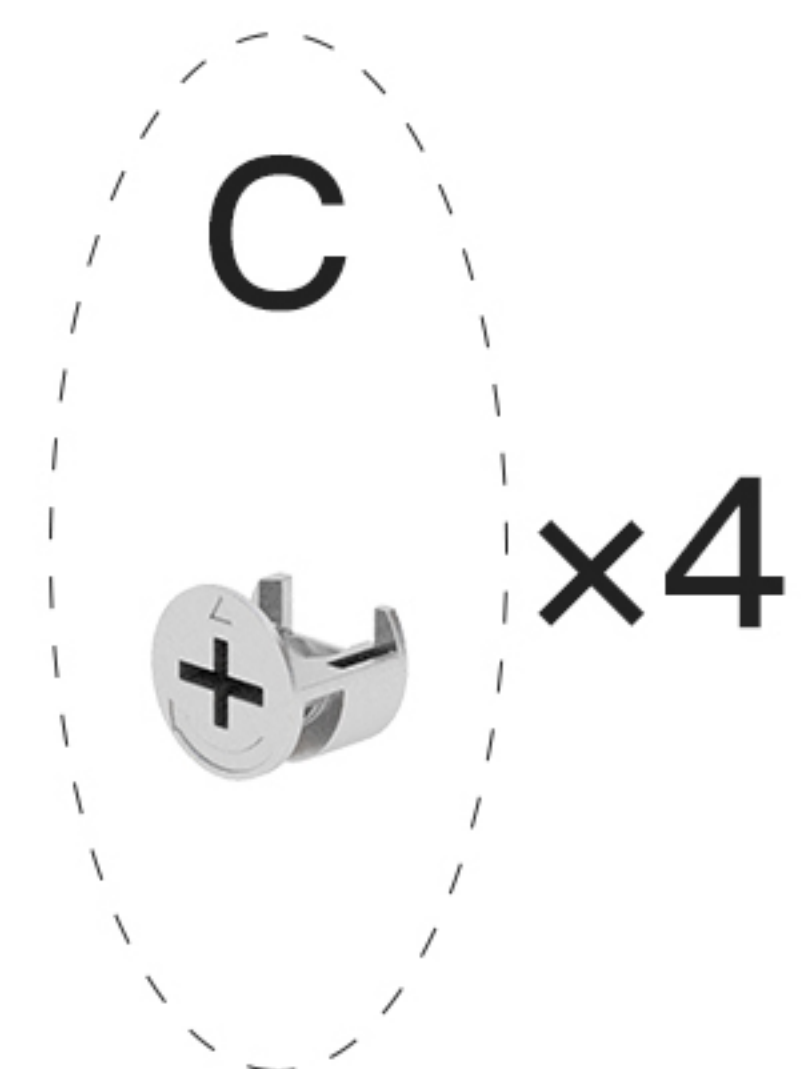
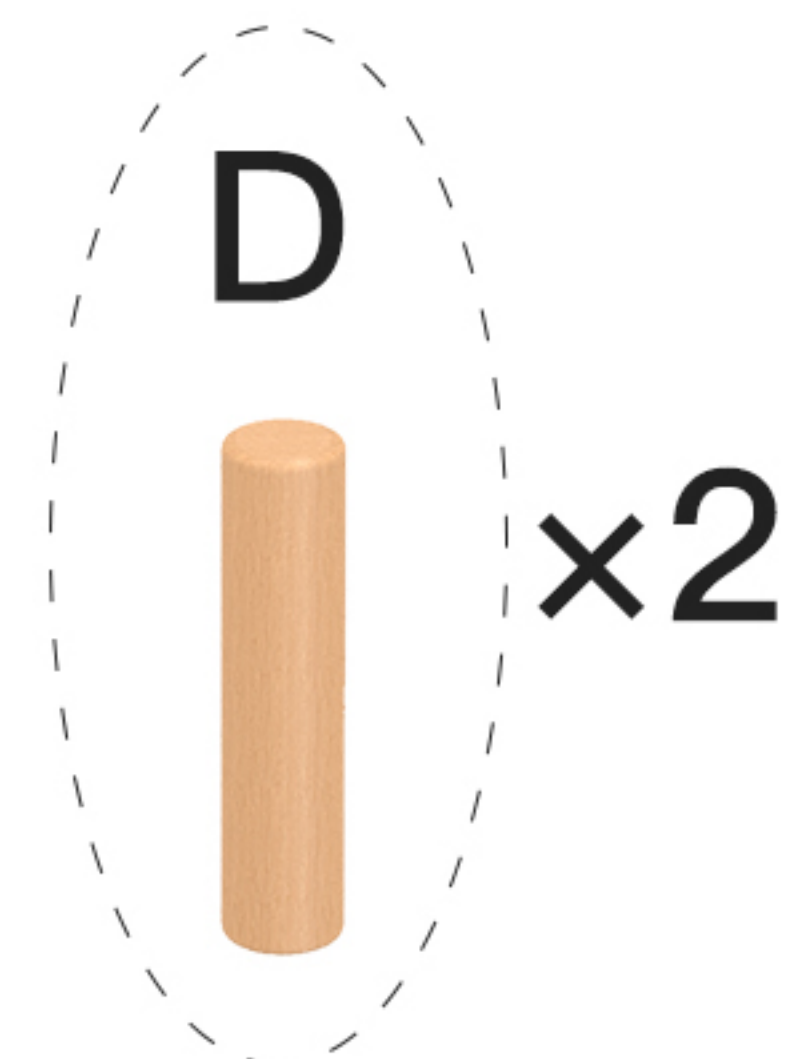
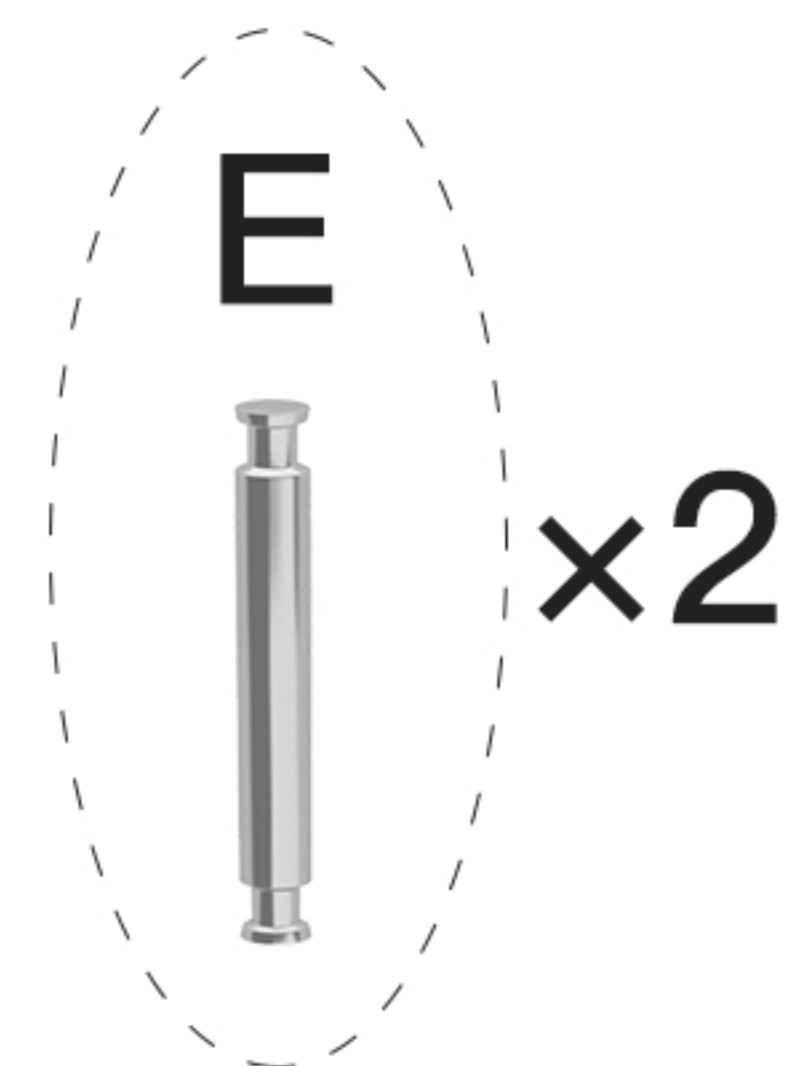
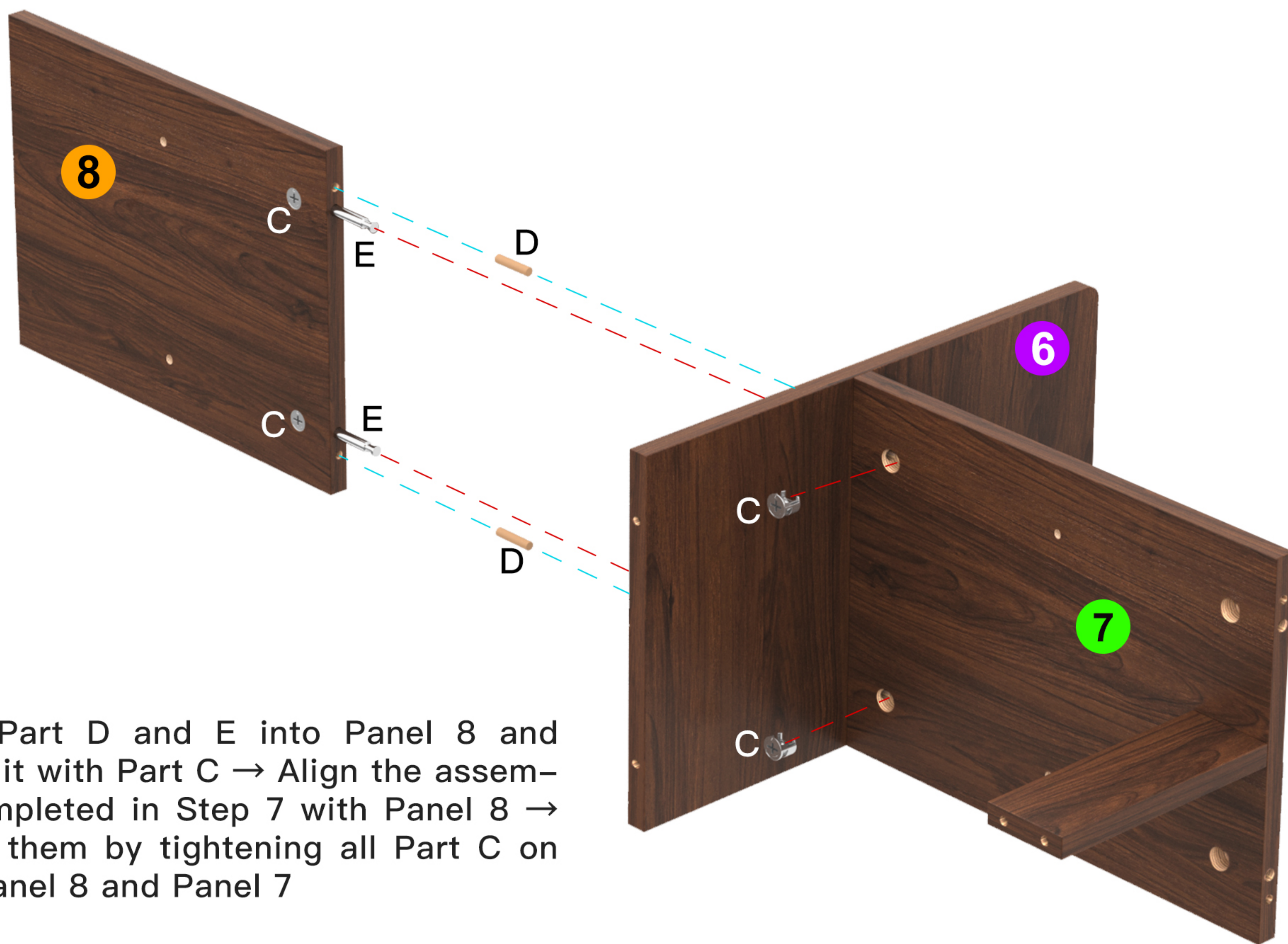

Insert Part D and E into Panel 8 and secure it with Part C → Align the assembly completed in Step 7 with Panel 8 → secure them by tightening all Part C on both Panel 8 and Panel 7

Step 8

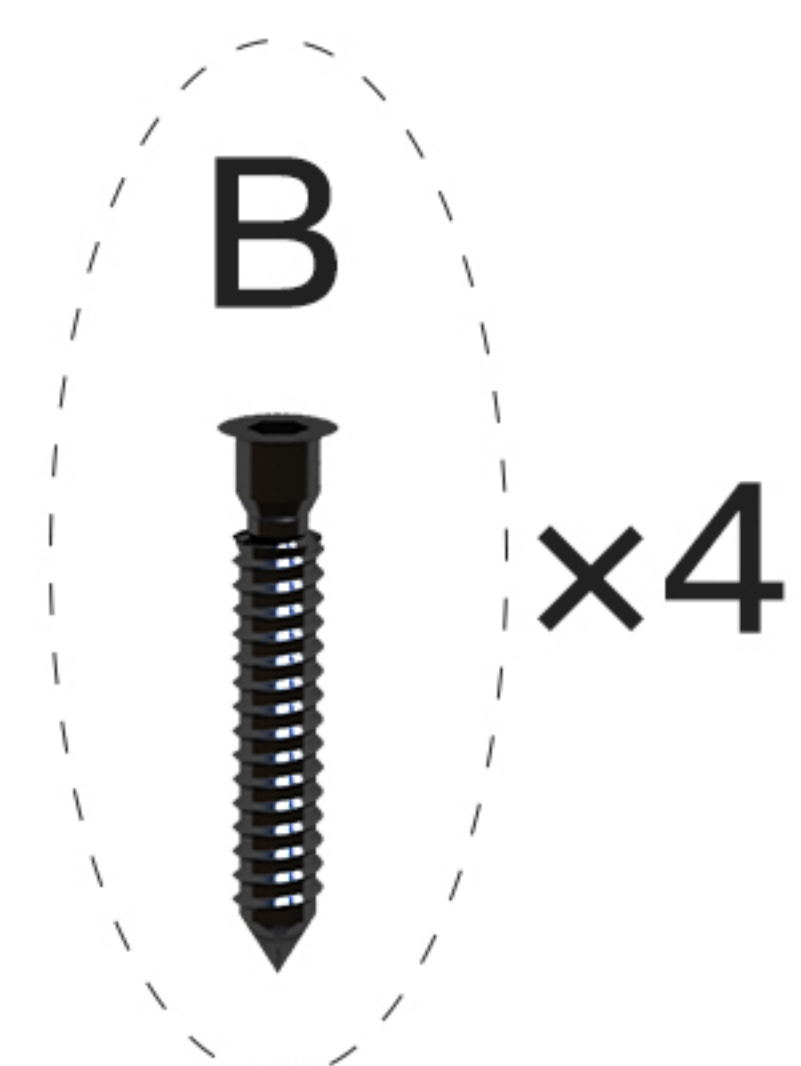
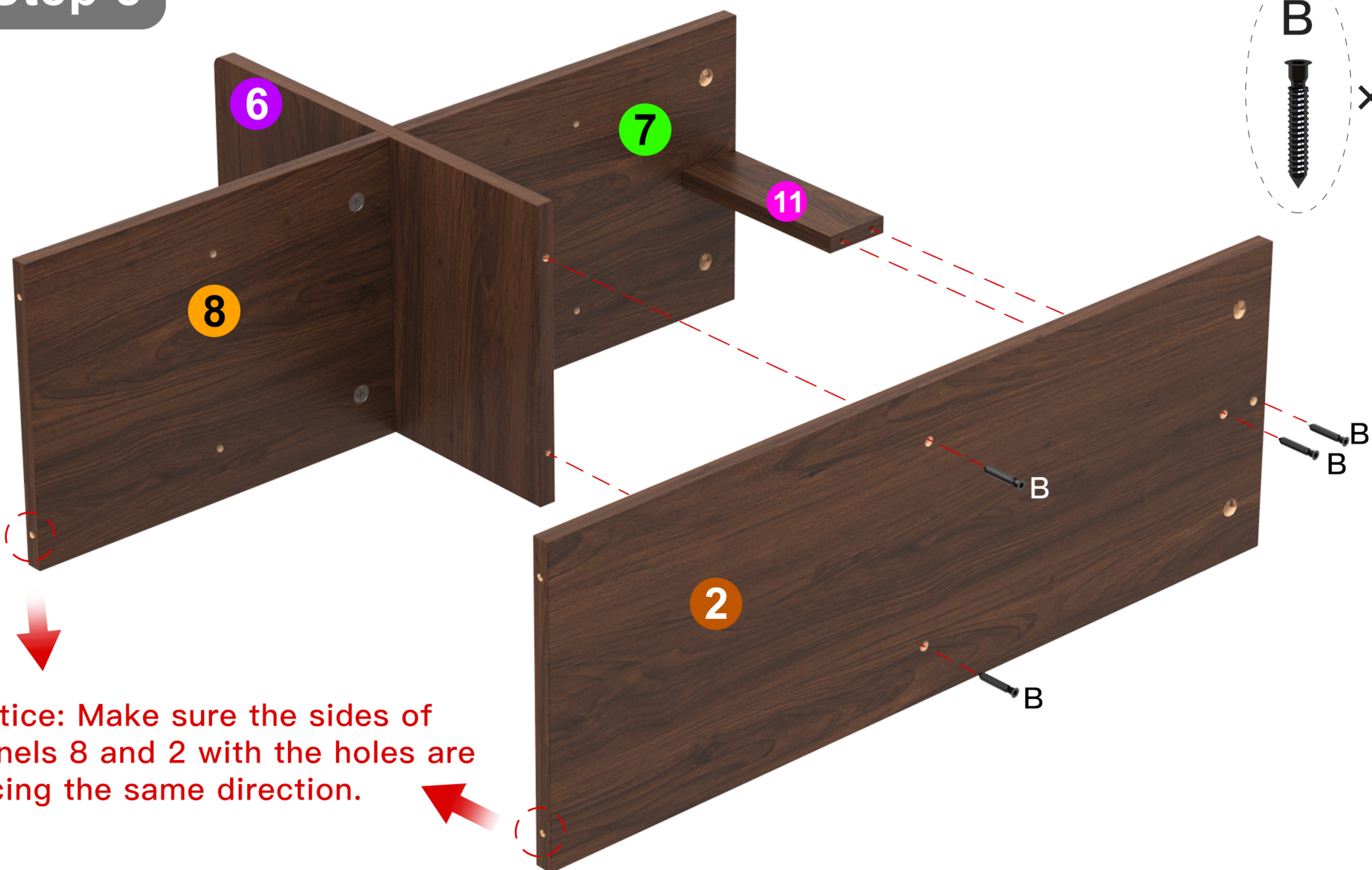

Notice: Make sure the sides of Panels 8 and 2 with the holes are facing the same direction.

Align Panel 2 with the assembly completed in Step 8 → secure them by tightening Part B

Step 9

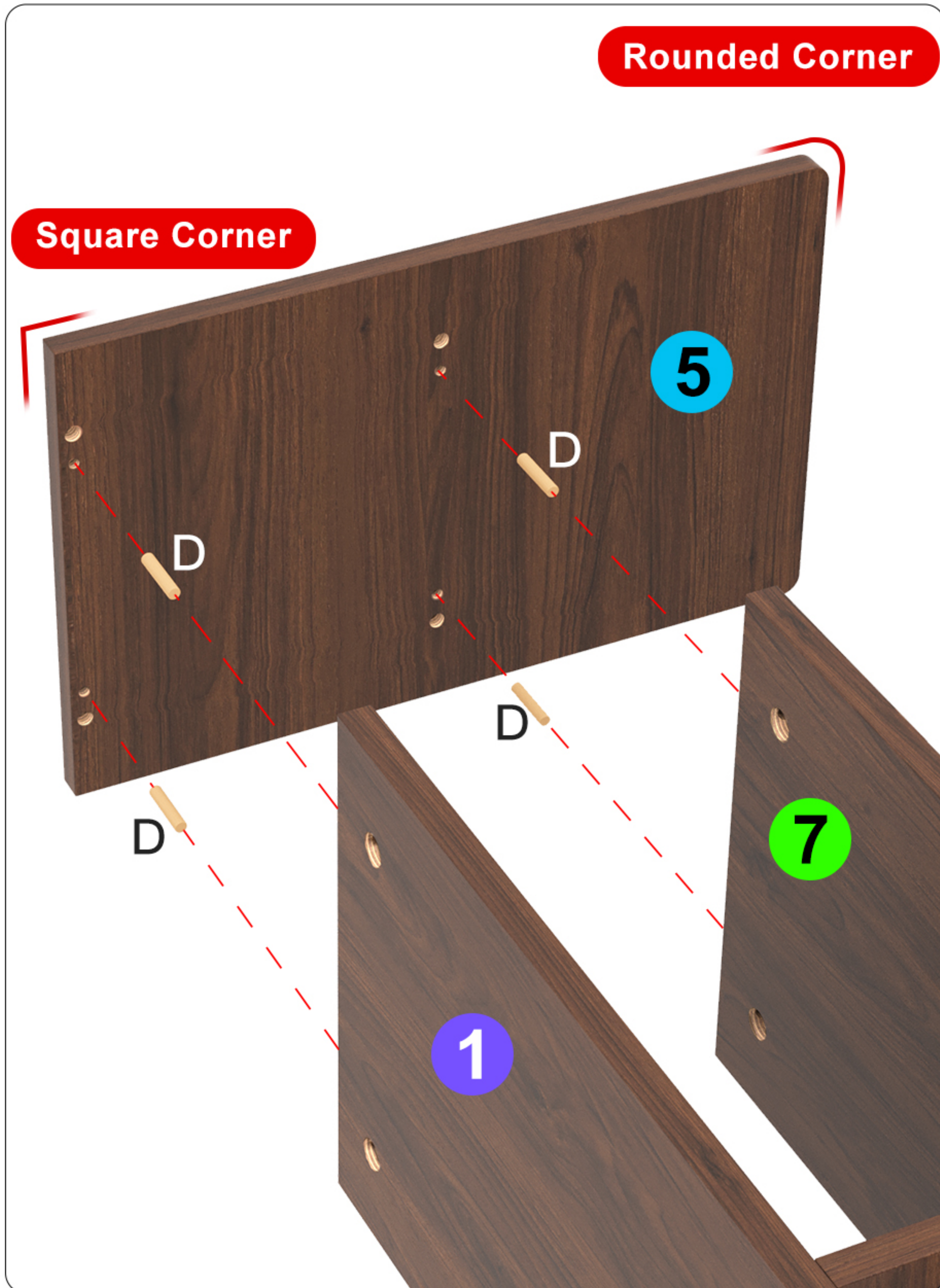

Insert Part D into Panel 5 (the side with smaller holes on the inner side)

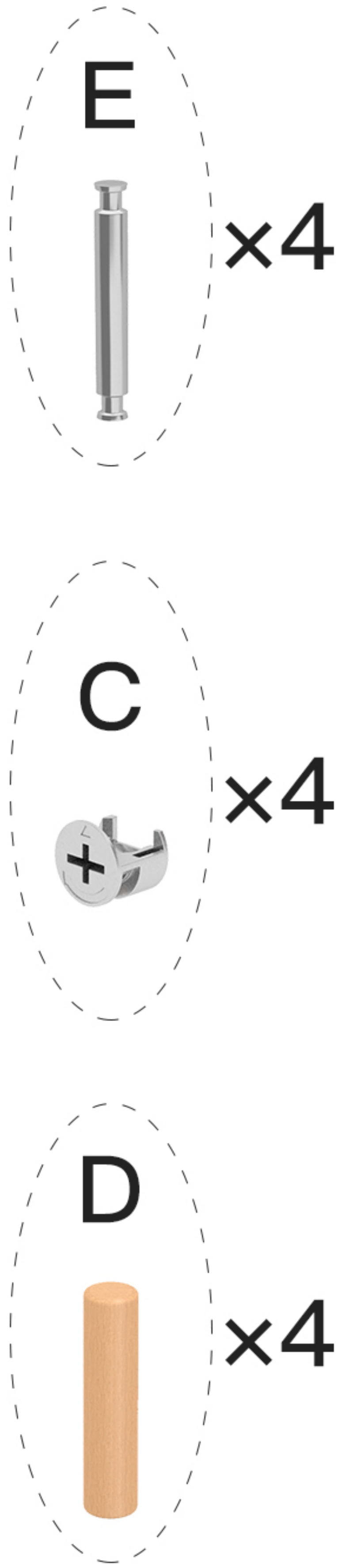
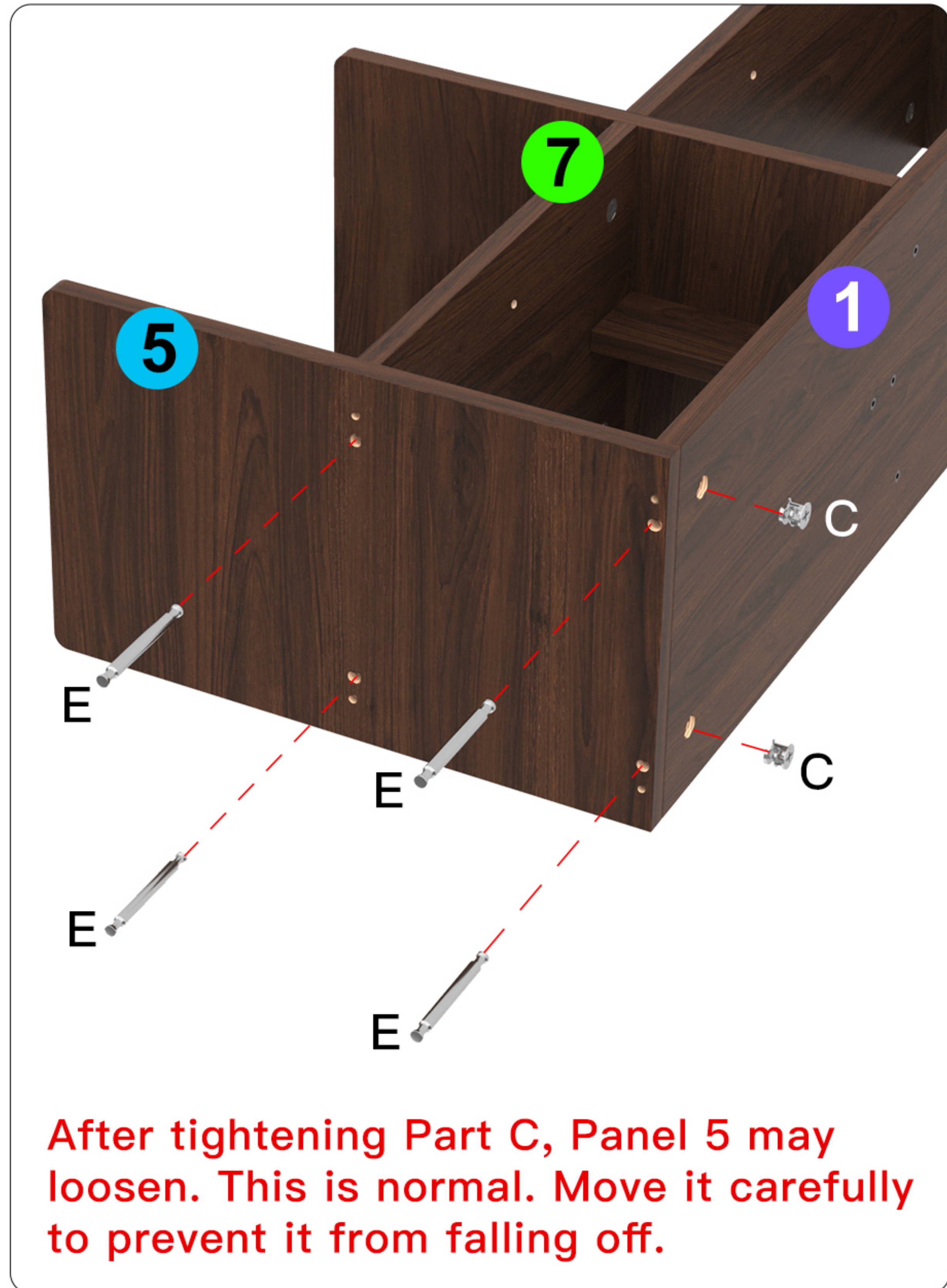

Step 10

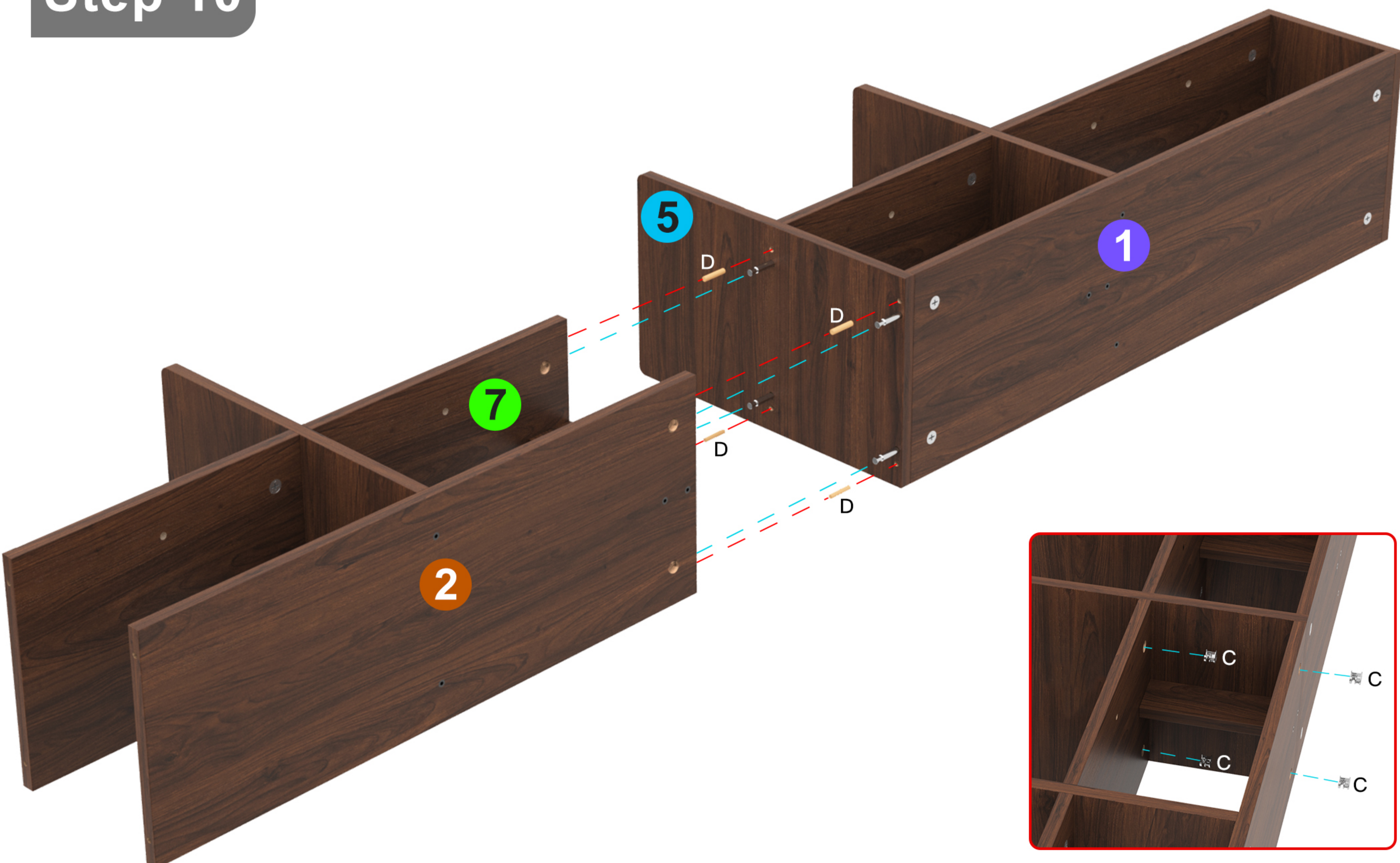

Insert Part D in Panel 5 → Align the assembly completed in step 9 with the one in step 8 → securing them by tightening Part C on Panel 7 and 2

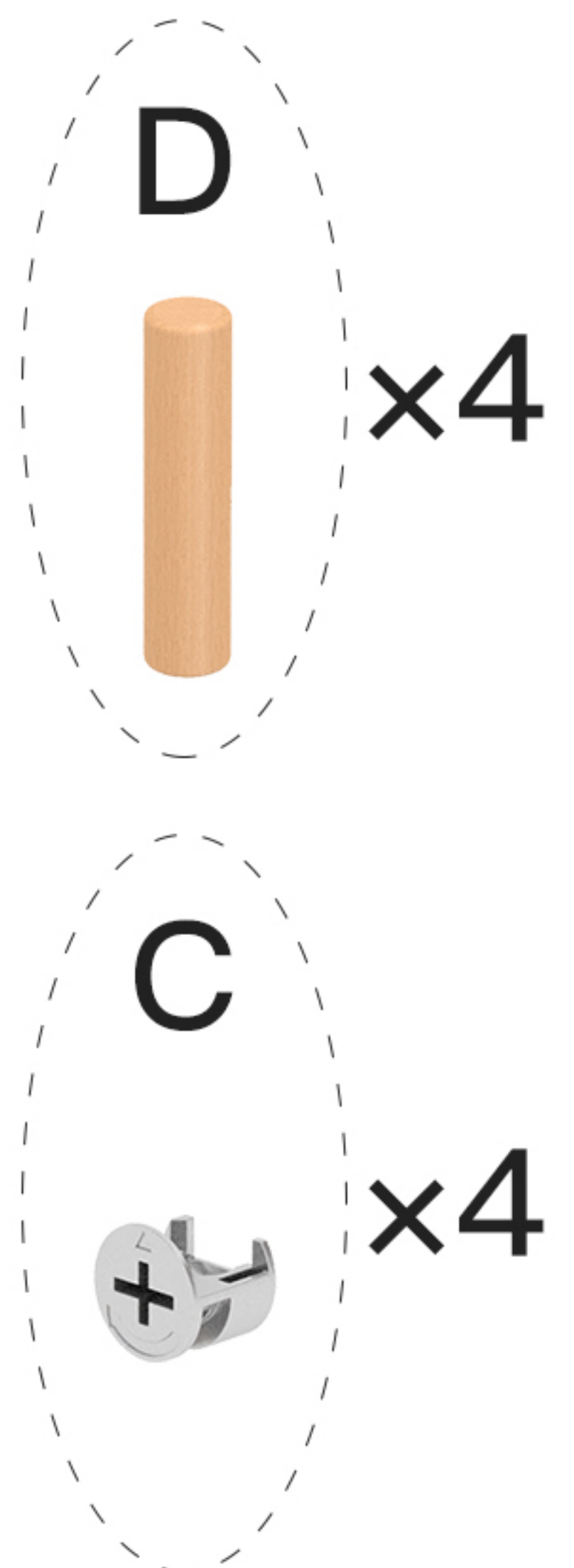

Step 11

Attach Part Y to the four corners of Panel 4

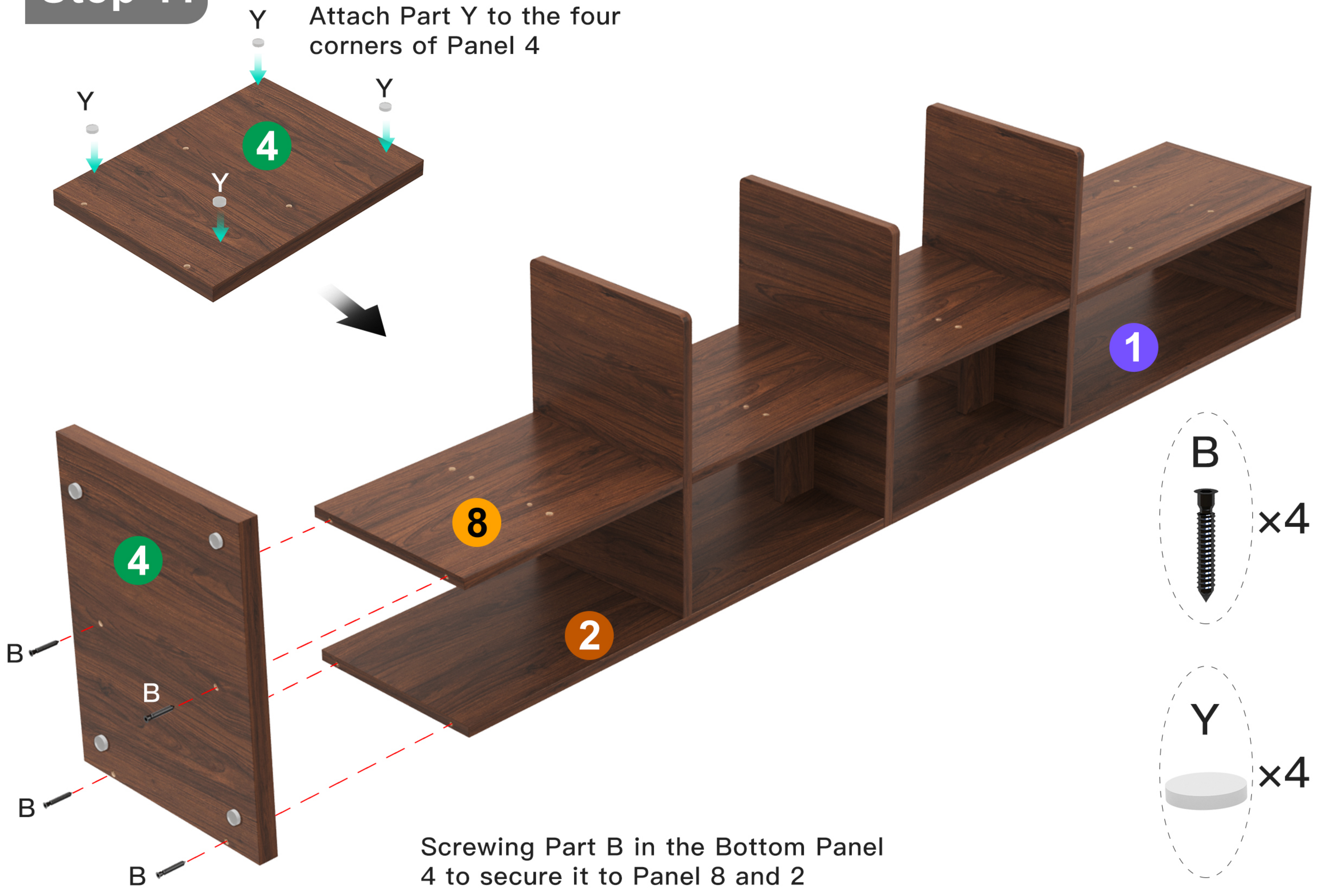

Screwing Part B in the Bottom Panel 4 to secure it to Panel 8 and 2

Step 12

Insert Part D into the two inner holes of Panel 10

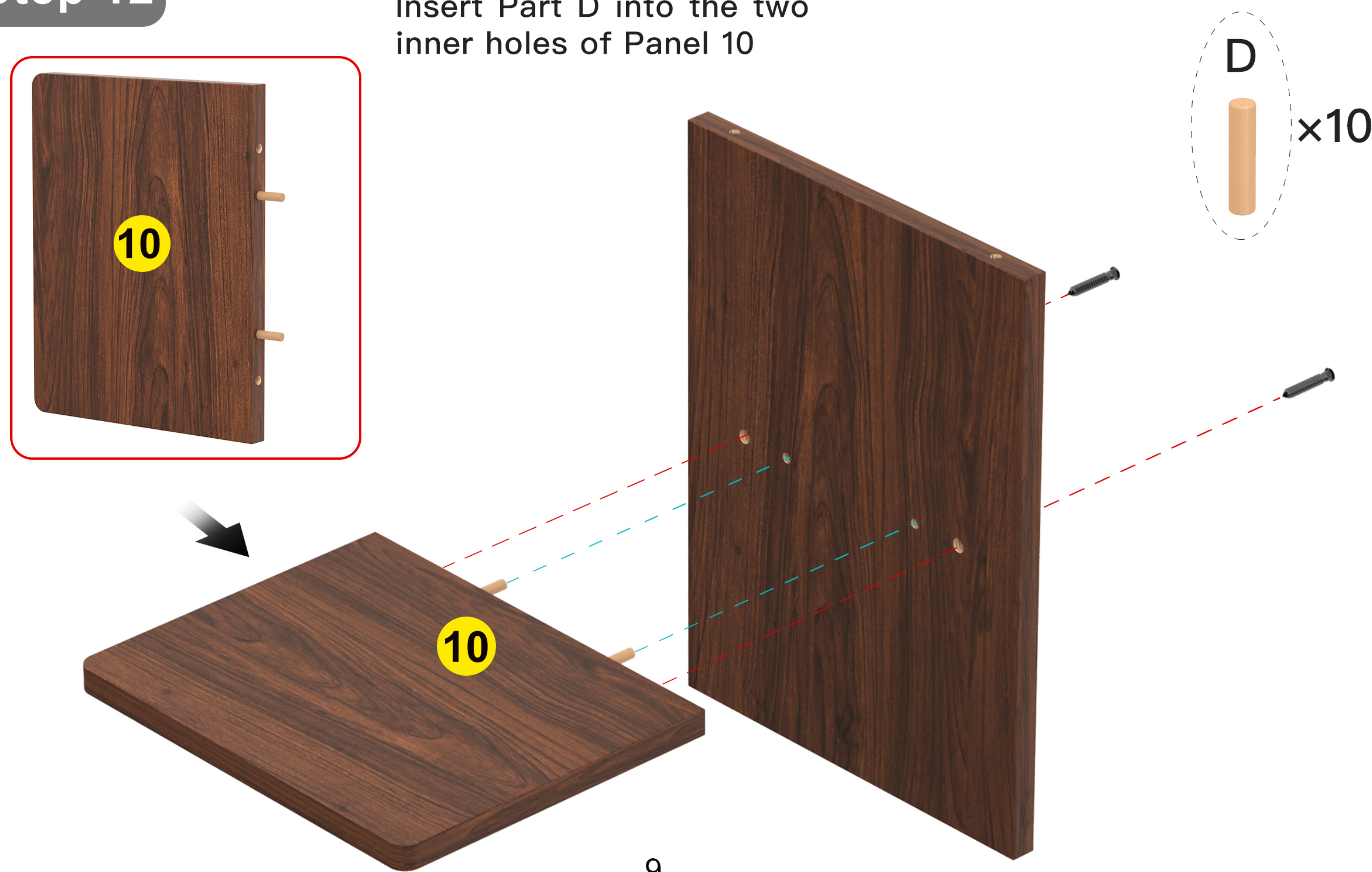

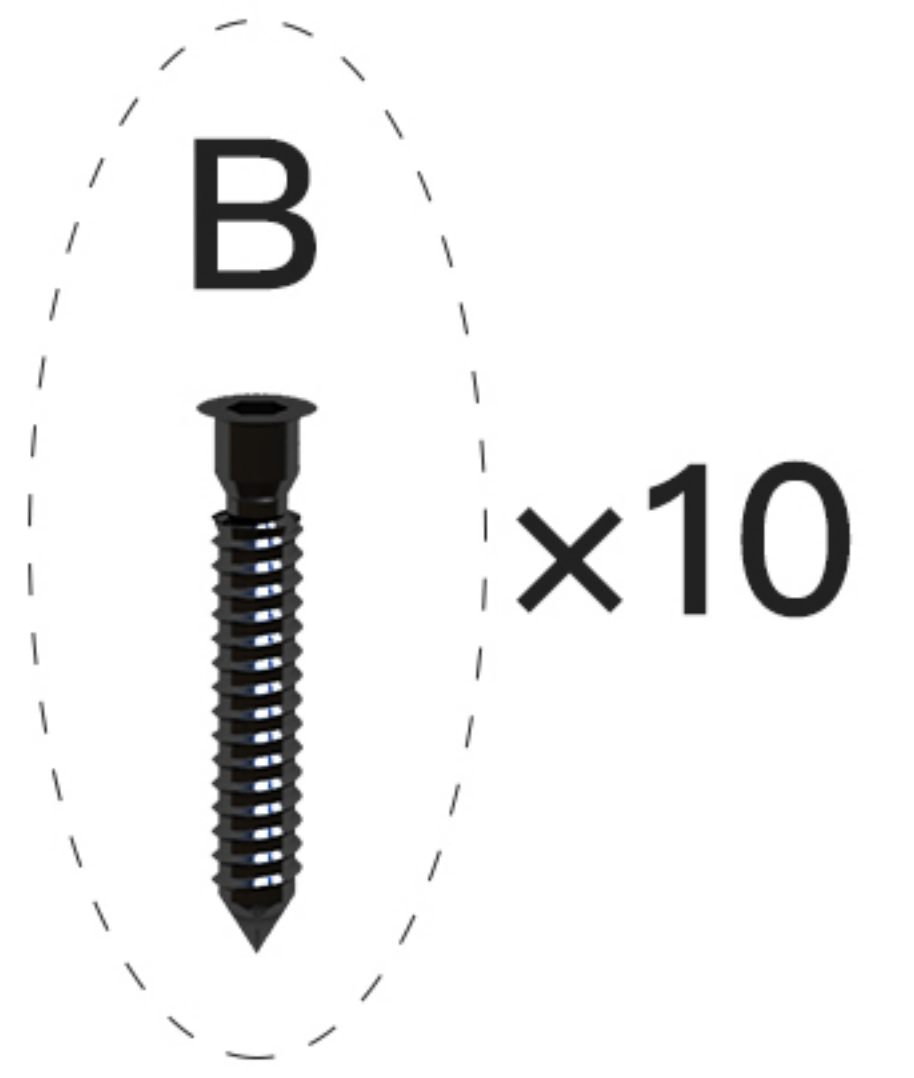
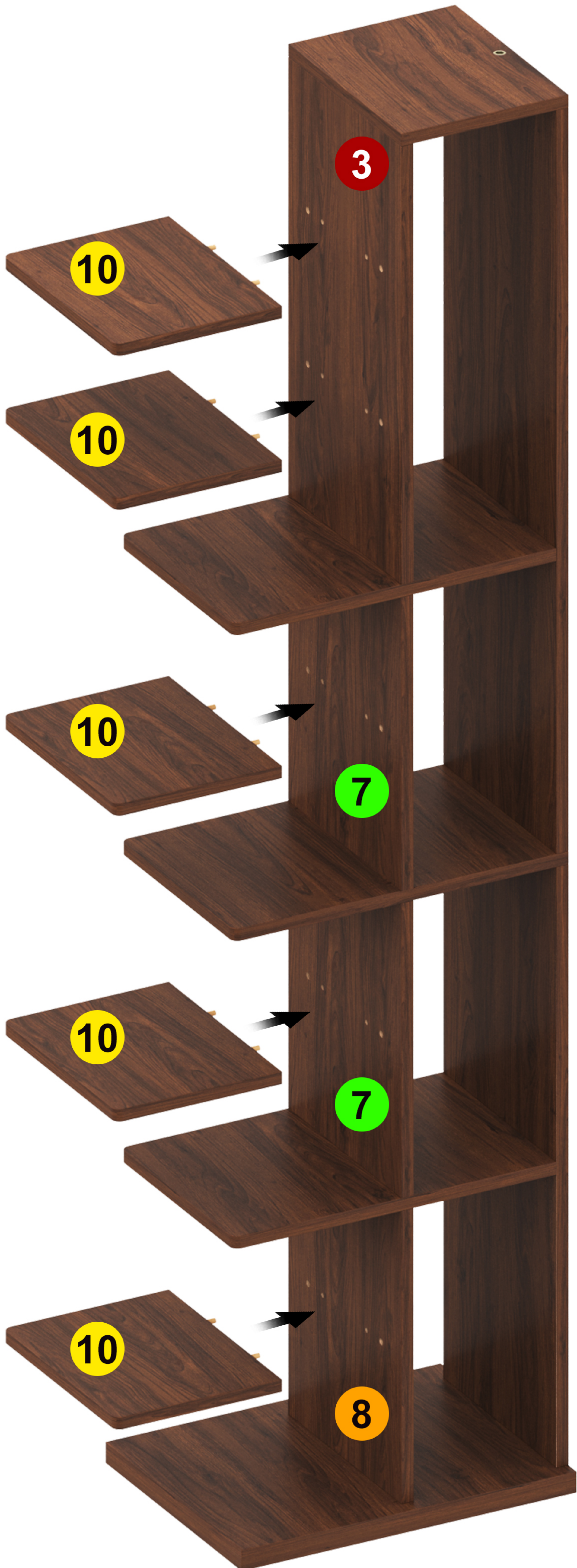

Locate the holes on Panels 3, 7, and 8 (a total of five rows of holes) → Align each Panel 10 with these holes and secure it with Part B → Repeat the above steps 5 times

Step 13

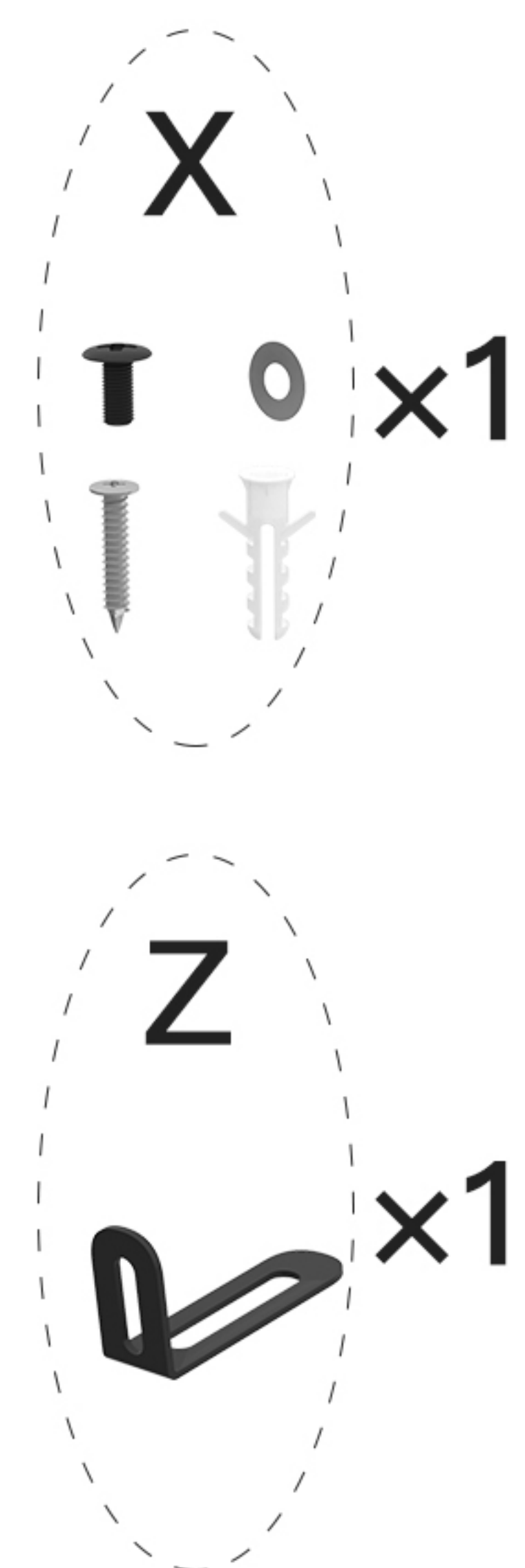
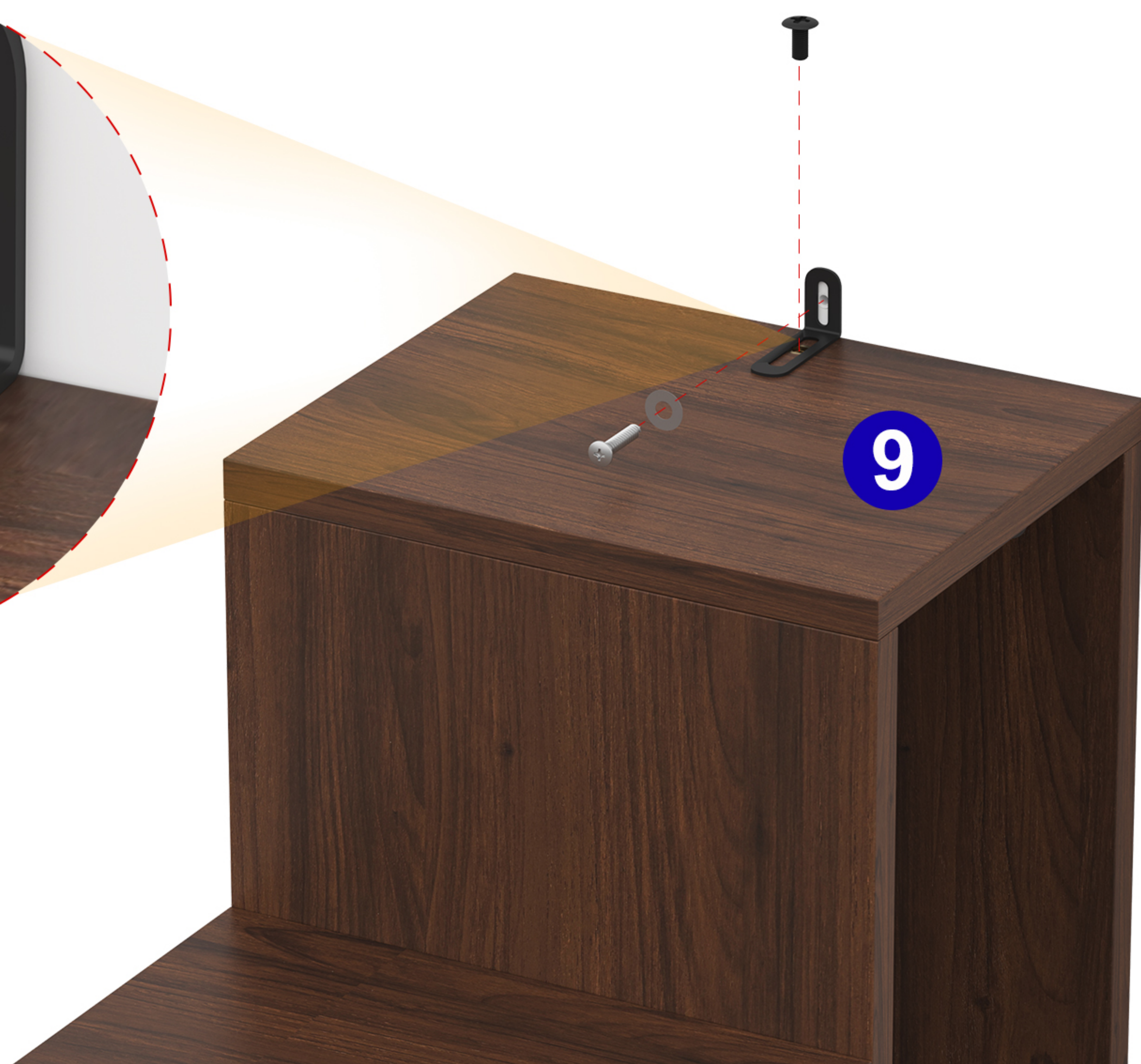

Make sure all parts are securely fastened, then carefully lift the product upright → You can install and secure Part X to the wall if needed