

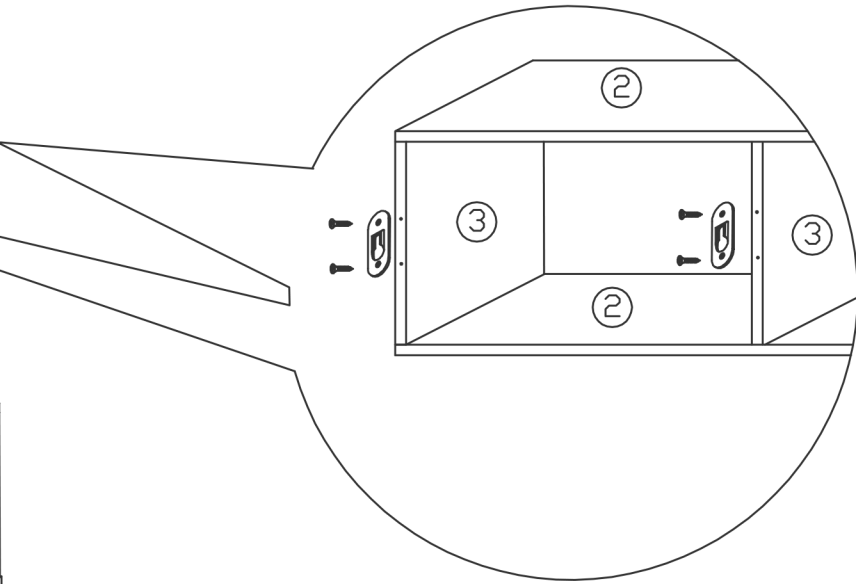

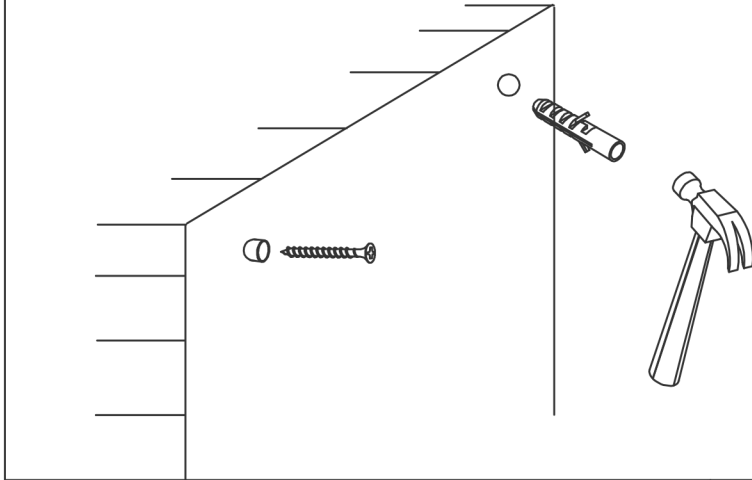

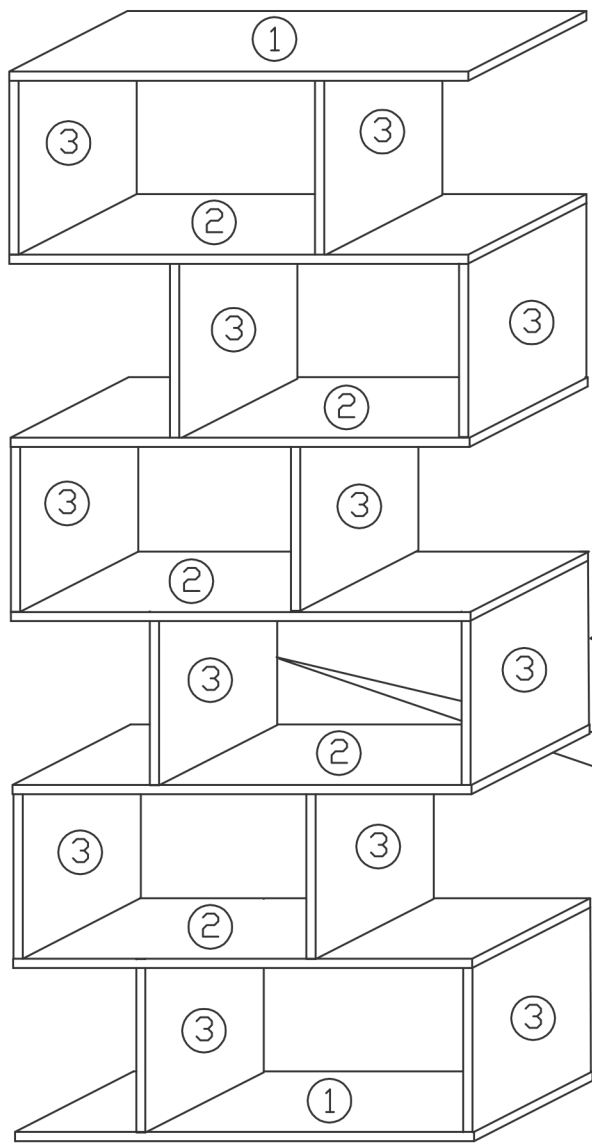



Please read these instructions and warranty information carefully before use and keep them properly for future reference.

OPERATING INSTRUCTIONS



A	3.5*14	4PCS	
B	3.5*35	48PCS	
C	4*50	2PCS	
D		48PCS	
E		2PCS	
F		2PCS	
G		48PCS	

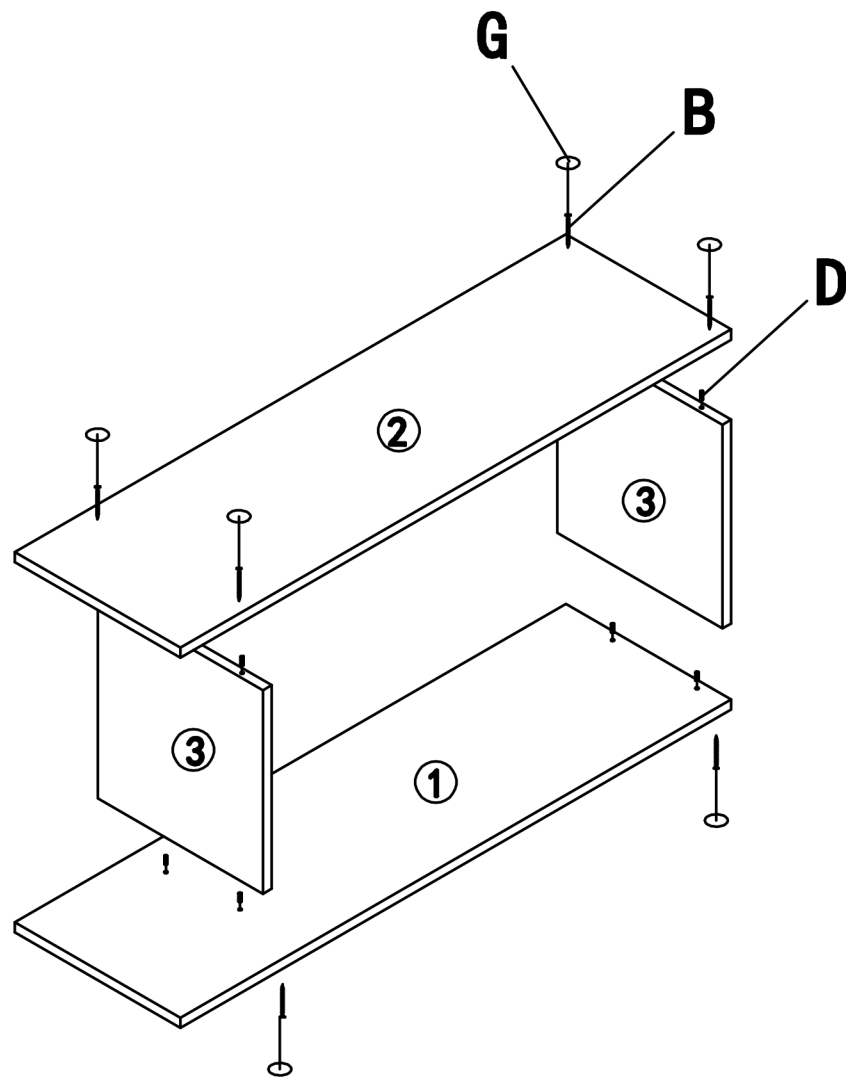

B*8

D*8

G*8

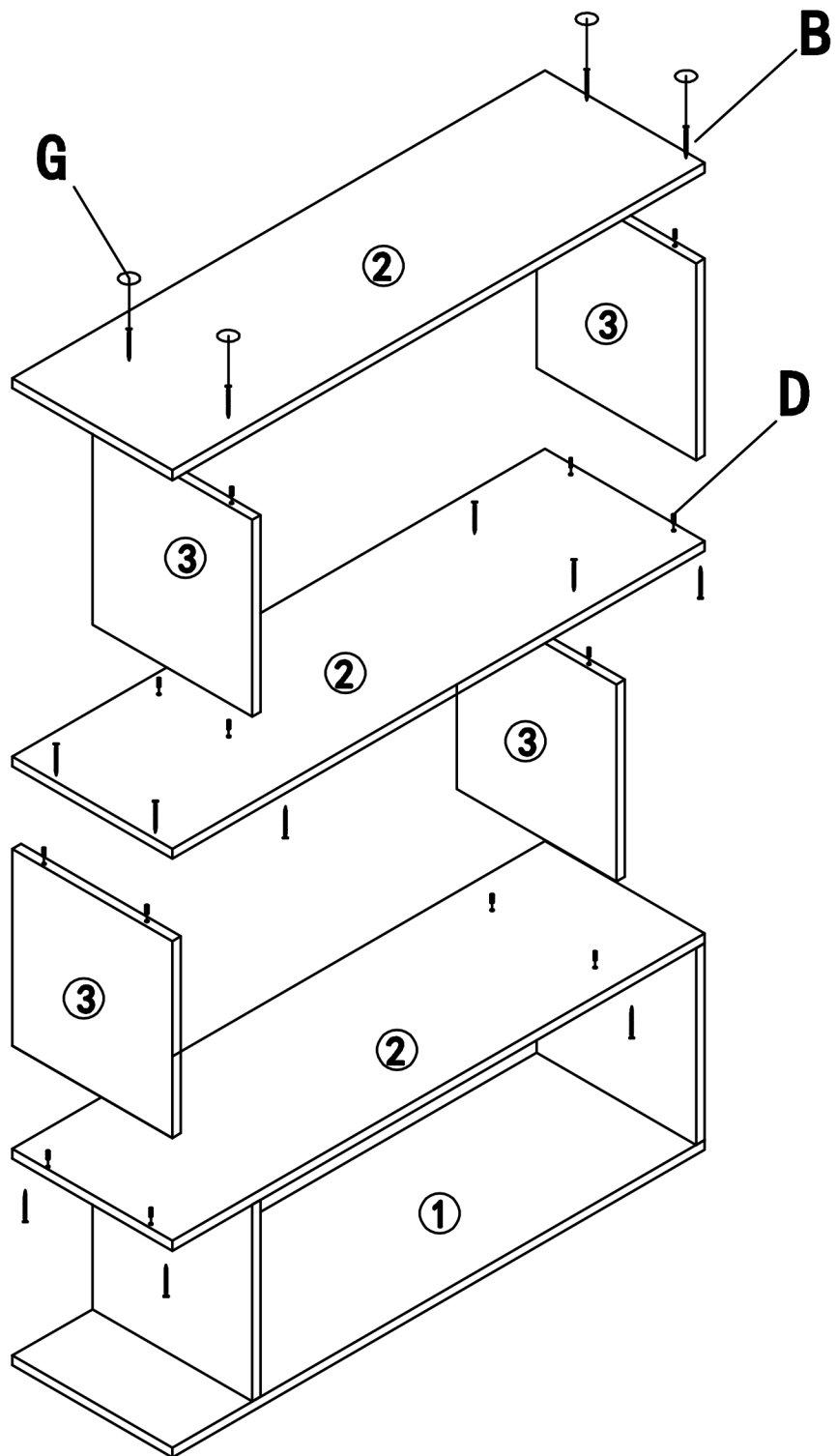

B*16
D*16
G*16

