

End Table

Congratulations on the purchase of your End Table. This end table has been crafted to the highest standards of quality and safety and will give you many years of enjoyment and practical use.

Because this end table is a natural bamboo product there will be variations in color and grain, and minor wood grain checking may occur. This is normal and does not compromise the integrity of your end table. Variation in the character of this piece is integral to its beauty and distinguishes it from lower quality composite materials.

Assembly is quite simple and requires only the Allen wrench provided. Assembly will be most easily accomplished if you take the time to carefully sort the hardware and familiarize yourself with the function of each piece.

Guide

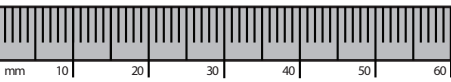

HARDWARE LIST

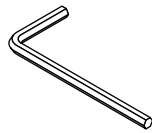

1x Allen Wrench



8x Lock Washers



8x Washers

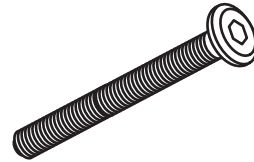

8x 60mm Allen bolts

PARTS LIST

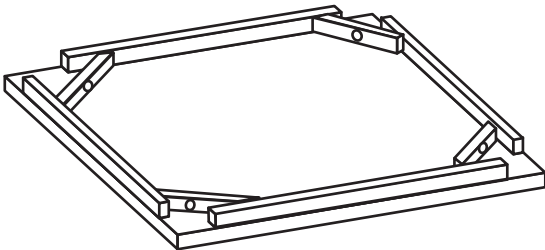

1x Table top

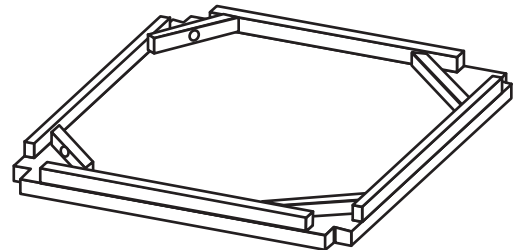

1x Lower Shelf

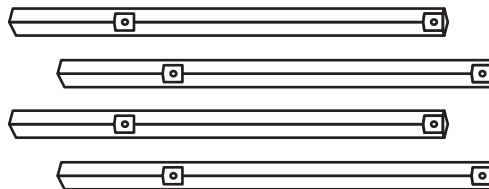

4x Table legs

Thank you and Enjoy

- 1** Carefully position the table top, top side down on a clean and soft surface.

Loosely attach each leg to the table top using a lock washer, a washer, and a 60mm bolt in all 4 pre-drilled holes in the bottom of the table top. As shown in **Diagram I**.

DO NOT TIGHTEN!

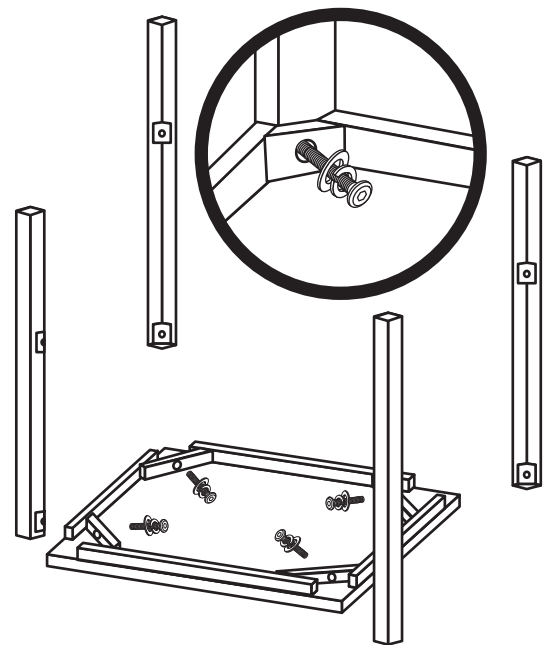
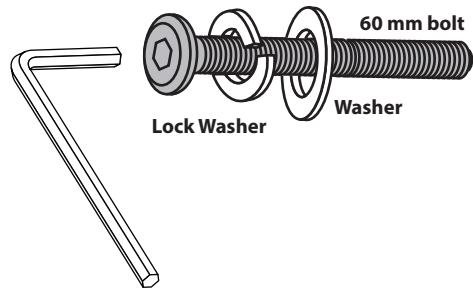

- 2** Slide the lower shelf, top side down, into position within the leg assembly aligning the pre-drilled holes in the legs with the pre-drilled holes in the bottom shelf. Loosely attach the lower shelf to the leg assembly with a lock washer, a washer, and a 60mm bolt in all four of the pre-drilled holes in the bottom of the lower shelf. As shown in **Diagram I**.

DO NOT TIGHTEN!

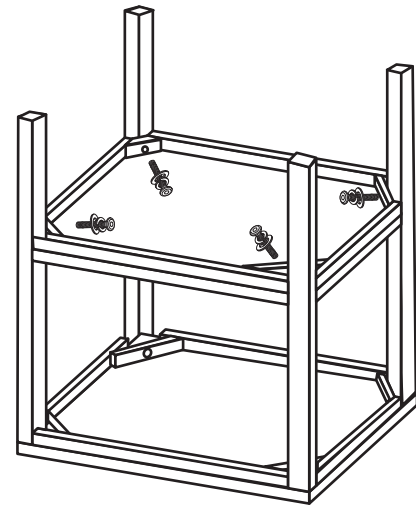

- 3** Carefully turn the end table right side up. Using the allen wrench tighten all of the 60mm bolts evenly.

You are now ready to enjoy your new End Table!

