

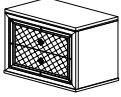





ASSEMBLY INSTRUCTION

Thank you for purchasing this quality product. Be sure to check all packing material carefully for small parts which may have loose inside the carton during shipment. Identify and count all parts and compare with the parts list below.

PART LIST#



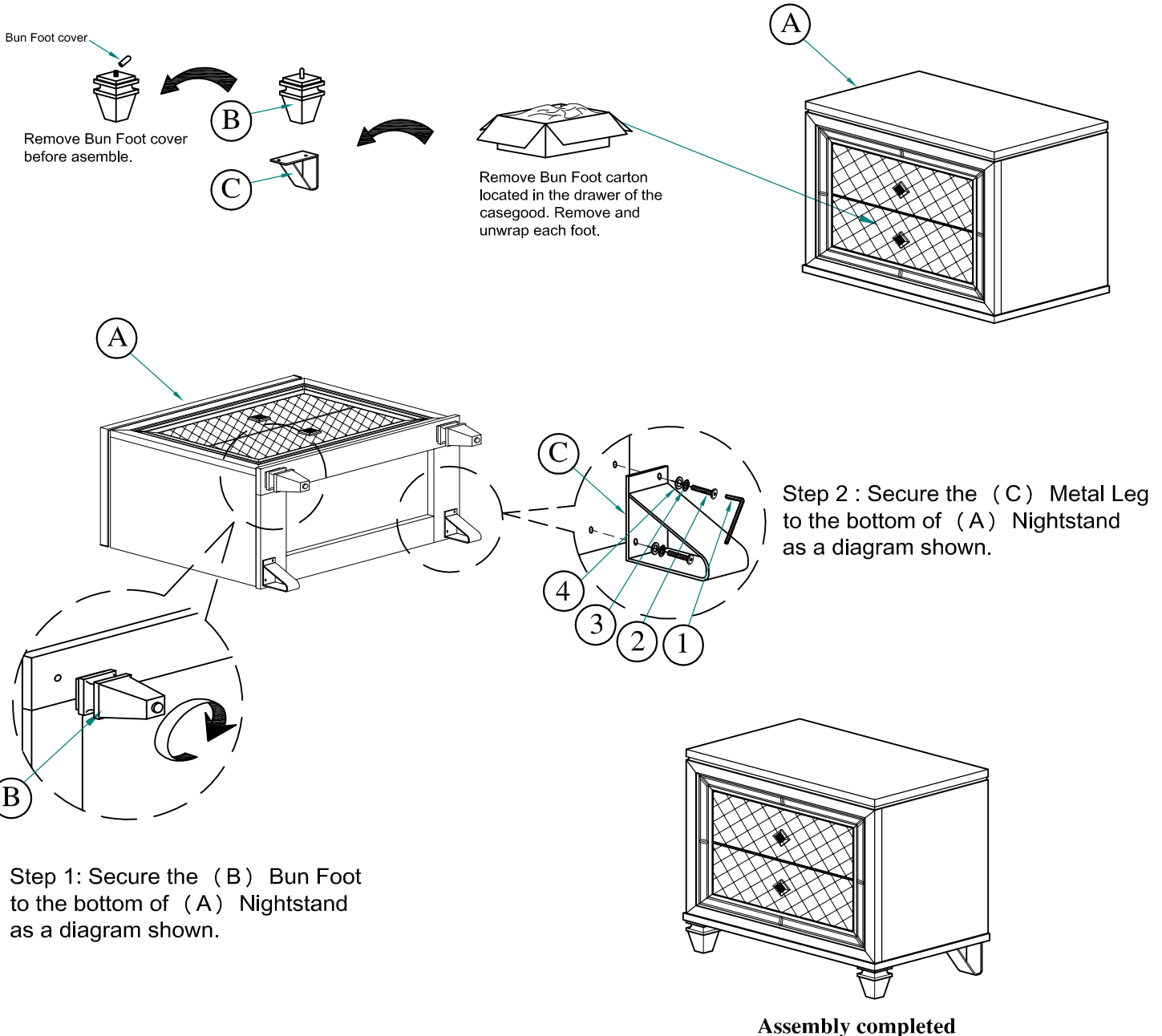

NO	DRAWING	DESCRIPTION	QTY
A		Night Stand	1pc
B		Bun Foot	2pcs
C		Metal Leg	2pcs

HARDWARE LIST#

NO	NAME	PART	QTY
1	Allen Key		1pc
2	JCBC - M6 x 20mm		4pcs
3	M6 Spring Washer		4pcs
4	M6 Flat Washer		4pcs



HARDWARE LIST (ANTI TIPPING)

NO	NAME	PART	QTY
A	Bracket		2pcs
B	Tie Wrap		1pc
C	Long Screw		1pc
D	Short Screw		1pc

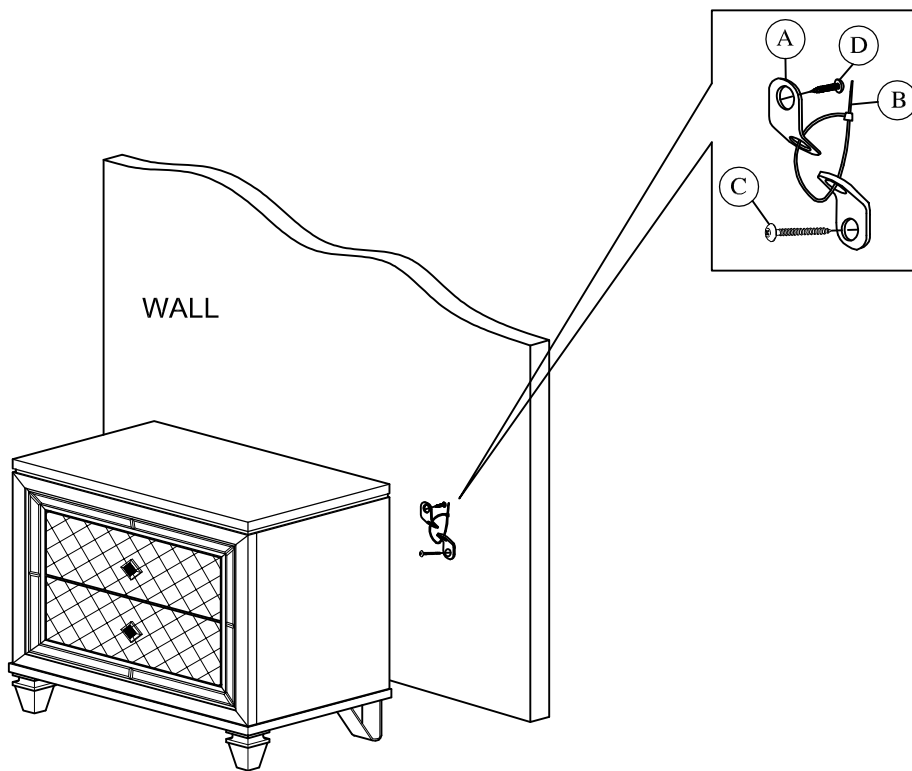

Assembly completed