



**INSTRUCTIONS D'ASSEMBLAGE
ASSEMBLY INSTRUCTIONS**

**TABLE D'APPOINT -
44"L / GRIS CIMENTE / VERRE TREMPE**

**ACCENT TABLE -
44"L / GREY CEMENT / TEMPERED GLASS**



**POUR DE L'ASSISTANCE OU POUR COMMANDER
DES PIÈCES CONTACTEZ NOTRE DÉPARTEMENT
DE SERVICE À LA CLIENTÈLE.**

**FOR ASSISTANCE OR TO ORDER PARTS
CONTACT OUR CUSTOMER SERVICE DEPARTMENT**

LISTE DES PIÈCES PARTS LIST

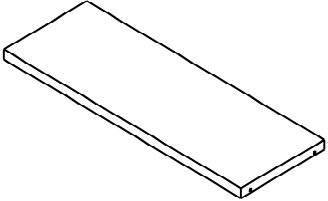
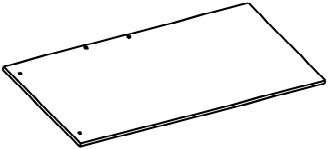
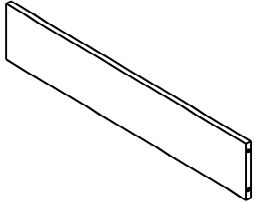
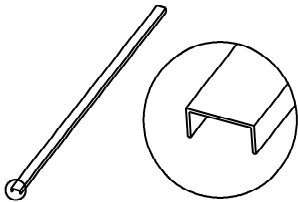
PIÈCE / PART #	IMAGE	DESCRIPTION	QTY / QTÉ
1		TABLE TOP SURFACE DE TABLE	1
2		GLASS PANEL PANNEAU EN VERRE	2
3		SUPPORT PANEL PANNEAU DE SOUTIENT	1
4		PLASTIC BAR BARRE DE PLASTIQUE	2

LISTE DES PIÈCES DE MONTAGE HARDWARE LIST

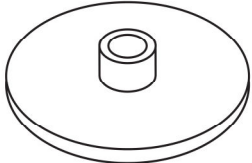
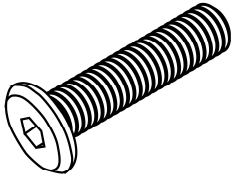
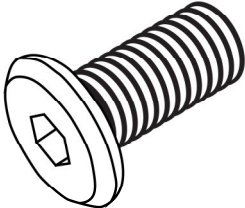
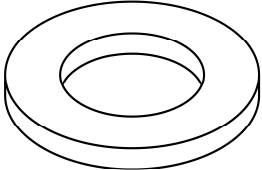
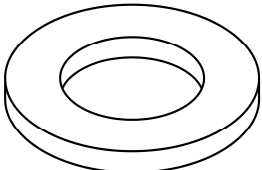
PIÈCE / PART #	IMAGE	DESCRIPTION	QTY / QTÉ
A		SCREW CAP - Ø1/4" X 1 3/8" CAPUCHON DE VIS - Ø1/4" X 1 3/8"	4
B		ASSEMBLING BOLT - Ø1/4" X 1 7/8" BOULON D'ASSEMBLAGE - Ø1/4" X 1 7/8"	4
C		ASSEMBLING BOLT - Ø1/4" X 1 1/2" BOULON D'ASSEMBLAGE - Ø1/4" X 1 1/2"	4
D		PLASTIC WASHER - Ø3/8" RONDELLE DE PLASTIQUE - Ø3/8"	4
E		PLASTIC WASHER - Ø1/4" RONDELLE DE PLASTIQUE - Ø1/4"	4

LISTE DES PIÈCES DE MONTAGE
HARDWARE LIST

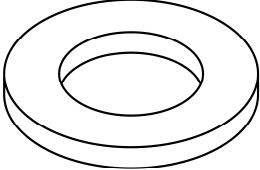
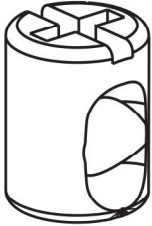
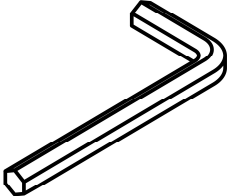
PIÈCE / PART #	IMAGE	DESCRIPTION	QTY / QTÉ
F		<p>METAL WASHER - Ø1/4"</p> <p>RONDELLE DE MÉTAL - Ø1/4"</p>	4
G		<p>BARREL NUT - Ø3/8"</p> <p>ÉCROU DE CANON - Ø3/8"</p>	4
H		<p>HEX KEY</p> <p>CLÉ HEXAGONALE</p>	1

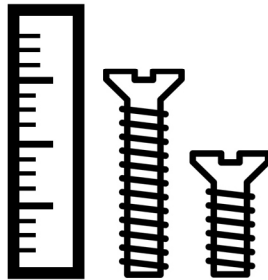

OUTIL DE VÉRIFICATION DE DIMENSIONS DES PIÈCES
HARDWARE DIMENSIONS VERIFICATION TOOL



ÉTAPE / STEP 1

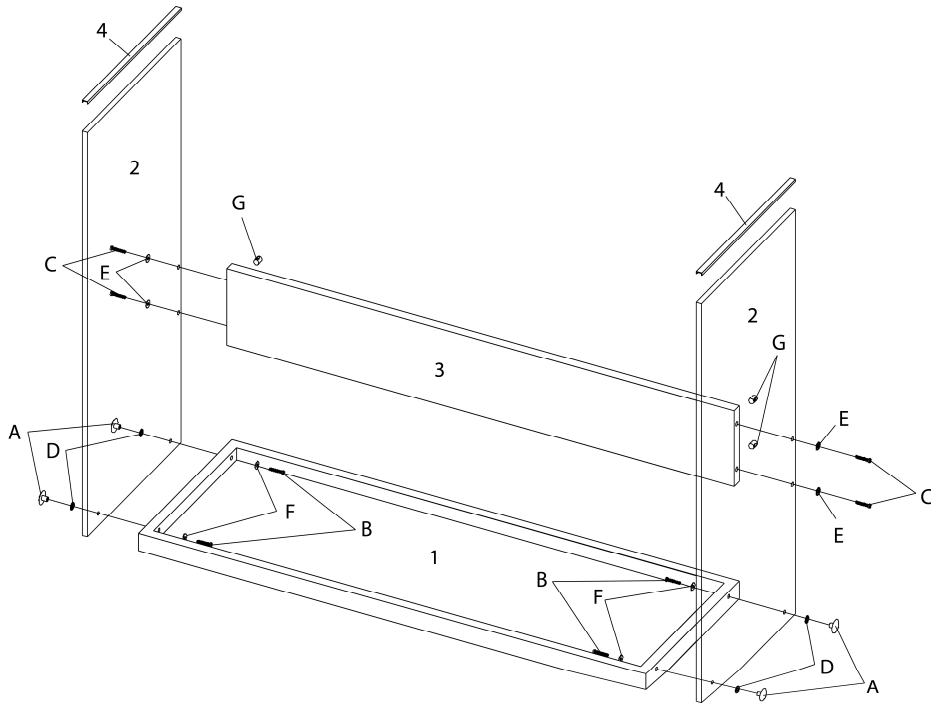

ÉTAPE / STEP 2

