

# ASSEMBLY INSTRUCTIONS



REVISION 0 : 07/11/2021  
REVISION 1 : 07/20/2022  
REVISION 2 : 08/28/2025

PAGE 1 OF 4

**SWIVEL ACCENT  
CHAIR**

# ASSEMBLY INSTRUCTIONS



## ASSEMBLY TIPS:

1. Remove hardware from box and sort by size.
2. Please check to see that all hardware and parts are present prior to start of assembly.
3. Please follow attached instructions in the same sequence as numbered to assure fast & easy assembly.



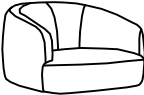

### **WARNING!**

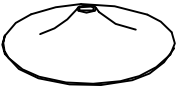
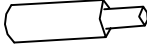
1. Don't attempt to repair or modify parts that are broken or defective. Please contact the store immediately.
2. This product is for home use only and not intended for commercial establishments.

## PARTS IDENTIFICATION

	PART NAME	FIGURE	QTY
<b>AN</b>	SEAT AND BACK		1PC
<b>BN</b>	SEAT PLATE		1PC
<b>CN</b>	BASE		1PC
<b>DN</b>	GAS LIFT		1PC

## HARDWARE IDENTIFICATION

	PART NAME	FIGURE	QTY
<b>1</b>	<b>ALLEN WRENCH (M4)</b>		<b>1PC</b>
<b>2</b>	<b>BOLT (1/4" x 55mm)</b>		<b>4PCS</b>
<b>3</b>	<b>SPRING WASHER (1/4")</b>		<b>4PCS</b>
<b>4</b>	<b>FLAT WASHER (1/4"*19* 2mm)</b>		<b>4PCS</b>

# ASSEMBLY INSTRUCTIONS

## STEP 1

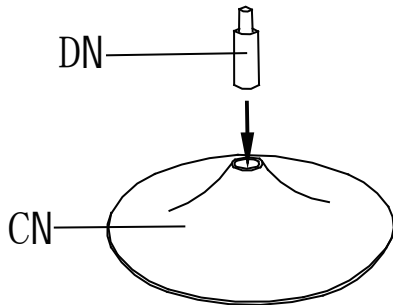

## STEP 2

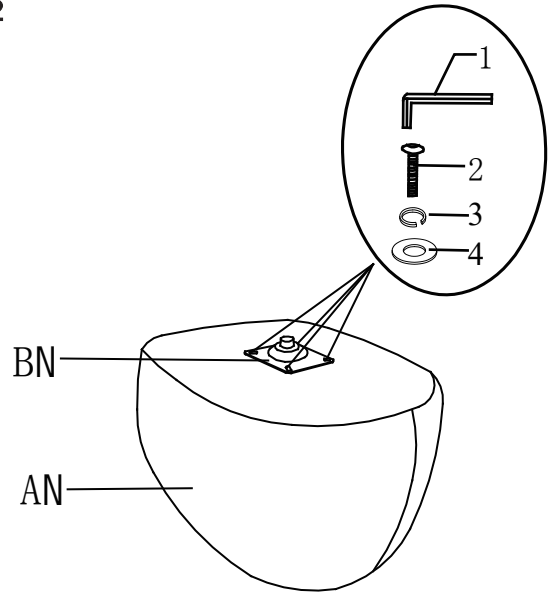

## STEP 3

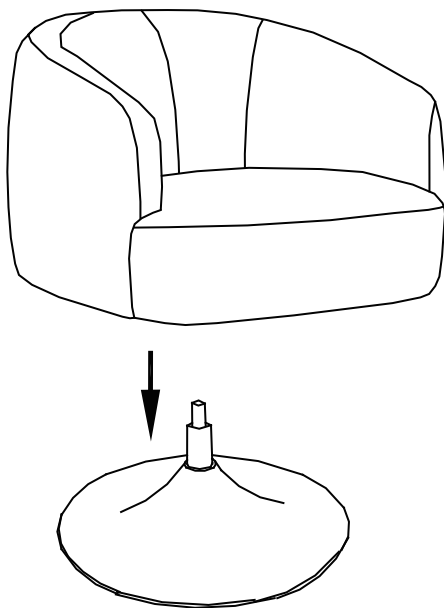

## STEP 4

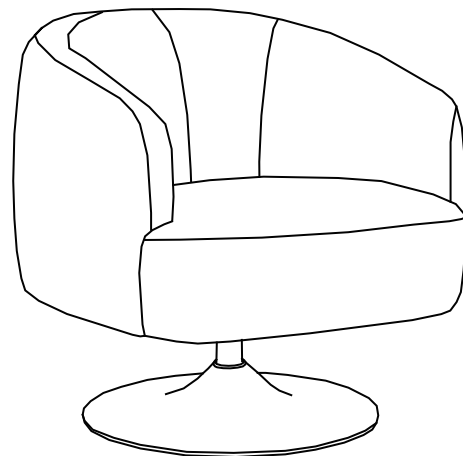

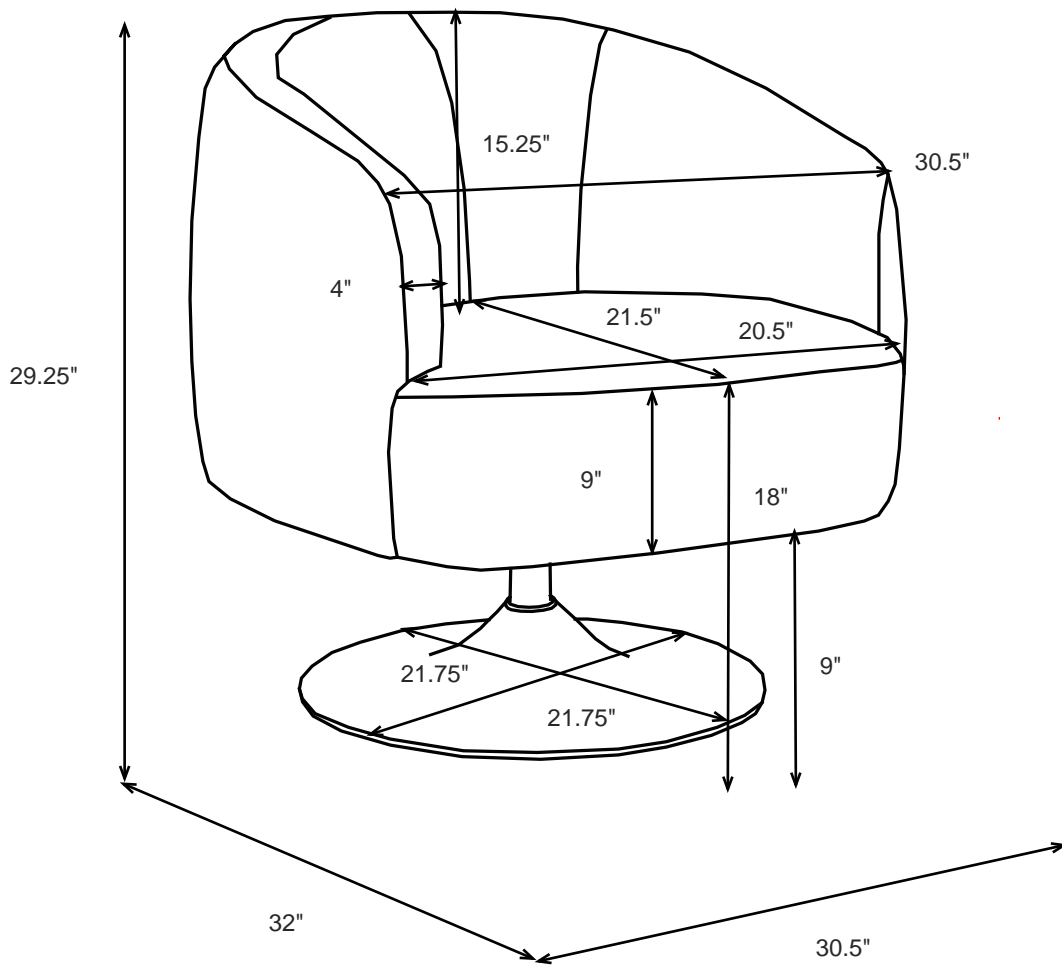

**Note :** Dimension tolerance  $\pm 5\%$