

ASSEMBLY INSTRUCTIONS FOR BED FRAMES F1 & F2

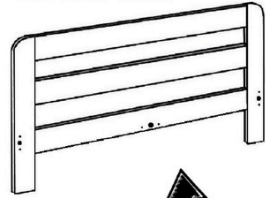

1 x Head-board



1 x Set of wooden slats

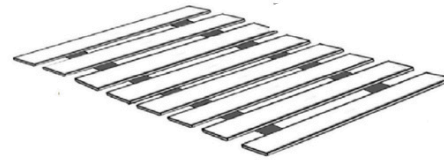

1 x Left hand side panel

The side panels are universal and when turned, the right one can be used on left side and vice versa.

1 x Right hand side panel

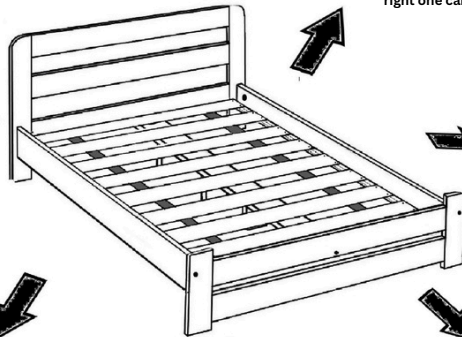

4 x Support legs

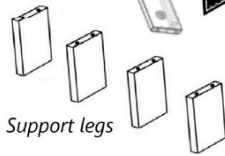

1 x Foot-board

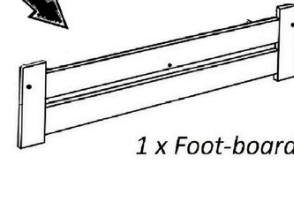

1 x Middle support plank

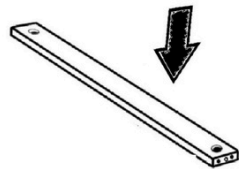

No. 1	No. 2	No. 3	No. 4	No. 5	No. 6	No.7	REQUIRED	RECOMMENDED
6 pcs.	6 pcs.	12 pcs.	32* pcs.	8 pcs.	1 pc	4 pc	NOT INCLUDED	

THIS PRODUCT COMES IN THREE BOXES AND EACH BOX CONTAINS PARTS AS BELOW:

Box 1 of 3 - head-board , footboard , 4 x support legs & fittings

Box 2 of 3 - 2 x Side panels, middle support plank

Box 3 of 3 - Set of solid wooden slats (super-king size beds comes with two sets of slats)

*Super-king bed comes with 64 wood screws for slats

PLEASE NOTE: The guarantee will not cover damages caused by failure to follow these assembly instructions, and returns will not be accepted for products incorrectly assembled.



STEP 1

MOUNTING FOUR SUPPORTIVE LEGS TO THE MIDDLE SUPPORT

FOR STEP 1 YOU WILL NEED

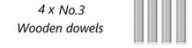
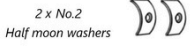
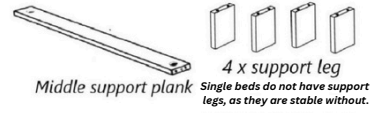
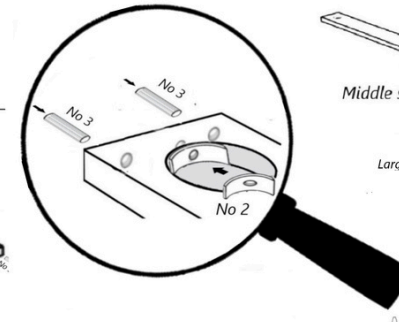
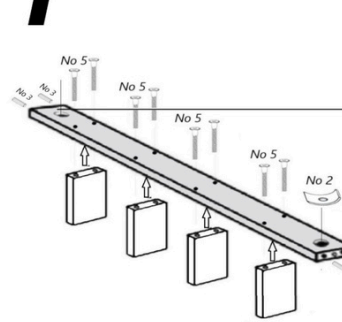

A hammer is NOT INCLUDED, but we recommend it to insert wooden dowels, if you have one.

STEP 2

MOUNTING THE MIDDLE SUPPORT TO THE HEAD-BOARD/FOOT-BOARD

FOR STEP 2 YOU WILL NEED

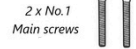
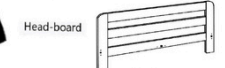
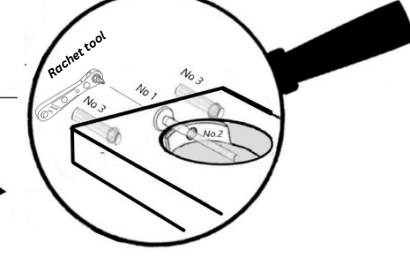
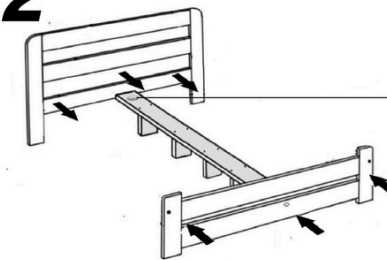

STEP 3

MOUNTING LEFT AND RIGHT-HAND SIDE PANELS TO THE HEAD-BOARD AND FOOT-BOARD

FOR STEP 3 YOU WILL NEED:

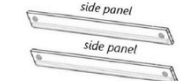
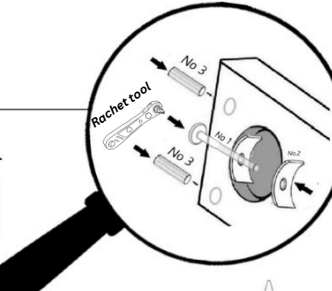
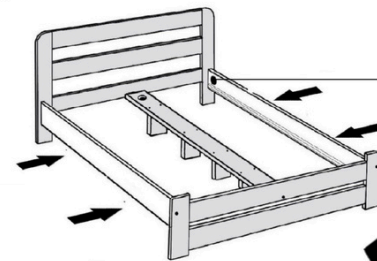

A hammer is NOT INCLUDED, but we recommend it to insert wooden dowels, if you have one.

STEP 4

MOUNTING THE SET OF SLATS TO THE SIDE PANELS

FOR STEP 4 YOU WILL NEED:

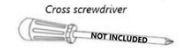
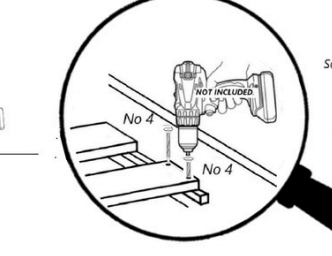
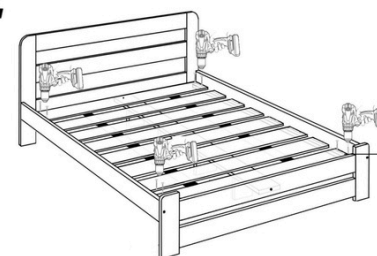

There is no need to screw in every slat, but at least the first slat (nearest to headboard) and the last slat (nearest to footboard) must be connected to the side panels with wood screws No. 4 to ensure adequate stability.