

Assembly Instructions

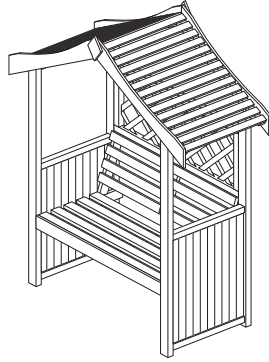

Before assembly

- We recommend that time is taken to read the instructions before starting assembly, then follow the easy step by step guide. The instruction sheet is only a guide to the assembly. Certain items may not be shown to scale.
- Check all components prior to assembly
- Drill all components where indicated.
- This product should be assembled by no less than two people.
- Never attempt to erect the assembly in high winds.



Recommended tools for assembly

- Cross head screw driver
- Drill with 2mm diameter drill bit
- Step Ladder

No.	Components	Qty.
1	Left upright	1
2	Right Upright	1
3	Seat & back slats	9
4	Seat front rail	1
5	Seat support	1
6	Back support	1
7	Back lattice	1
8	Roof rafter	4
9	Roof slat sets	2
10	Bargeboards	4
11	Diamond finials	2

No.	Fixing kit	Qty.
12	Flat brackets	2
13	90mm screws	4
14	60mm screws	40
15	40mm screws	42
16	40mm nails	56

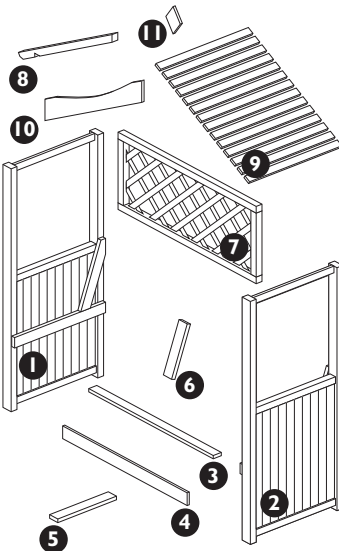

1. Seat slats

Evenly space five seat slats between the two uprights and secure to the top of seat bearers using 2 x 60mm screws at the ends of each slat. Secure the seat support centrally to the underside of the seats slats using 2 x 40mm screws per slat.

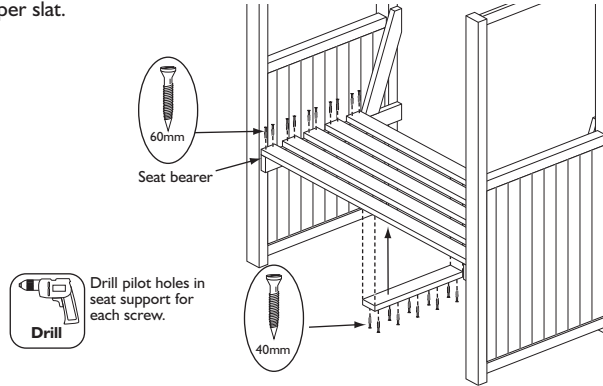

2. Seat back slats

Position the four seat back slats to the seat back bearers using 2 x 60mm screws at the ends of each slat. Secure the back support centrally to the back of the back slats using 2 x 40mm screws per slat.

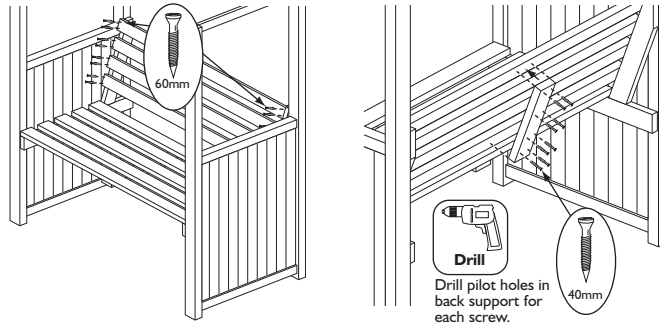

3. Back Lattice & front rail

Fix the front rail to the seat using 4 x 40mm screws. Position the back lattice on top of the seat back bearers, between the uprights. Secure in place using 4 x 60mm screws.

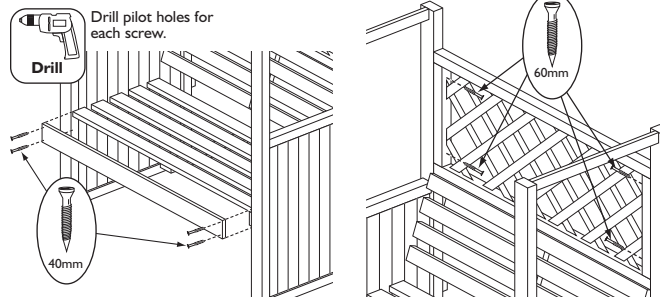

4. Roof assembly

Attach a set of roof slats to two roof rafters. Have the slats flush with the ends and edges of the rafters. Secure in place with 1 x 40mm nail at the ends of each slat. Create a second roof panel in the same way. Join the two roof panels together using the two flat brackets and 4 x 40mm screws per bracket.

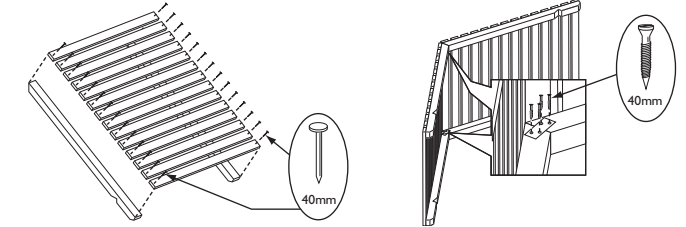

5. Roof to uprights

Position the roof on top of the uprights. Make sure the legs of the uprights fit into the rebates in the roof rafters. Secure using 1 x 90mm screw in each corner. Screw through the roof rafters into the ends of the upright legs.

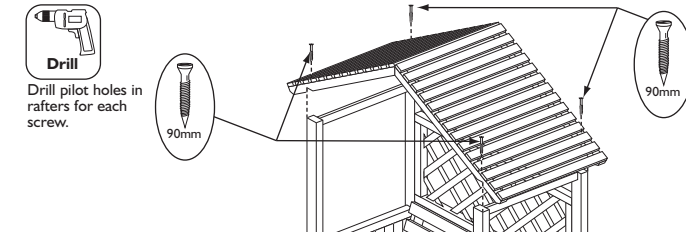

6. Bargeboards and finials

On both the front and rear of the roof, position two bargeboards, have them meet evenly at the apex and secure to the roof rafters using 2 x 40mm screws per bargeboard. Position a finial over the join between the two bargeboards and secure using 2 x 40mm screws per finial.

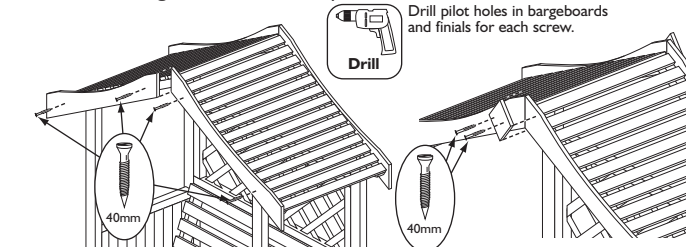

**IMPORTANT: RETAIN FOR FUTURE REFERENCE
READ CAREFULLY**

Periodically check all fastenings for tightness
For domestic use only

We constantly improve the quality of our products, occasionally the components may differ from the components shown and are only correct at time of printing. We reserve the right to change the specification of our products without prior notice.