







ASSEMBLY INSTRUCTIONS

 A M3.5*35 56PCS	 B M3.5*50 18PCS	 C M3.0*25 6PCS	 D M6.0*55 8PCS
 E M6.0*20 8PCS	 M3.0*16 12PCS  F 3PCS	 G 4PCS	

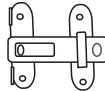

①

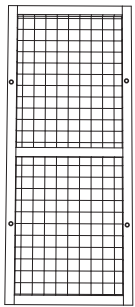
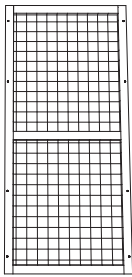

②

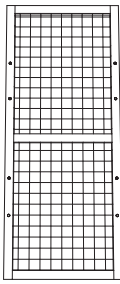

③ x2

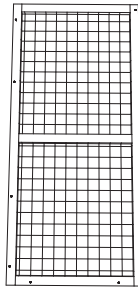

④

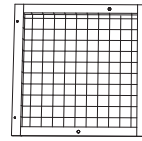

⑤

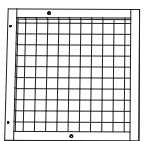

⑥

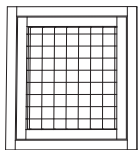

⑦

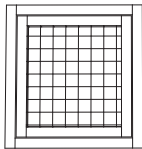

⑧

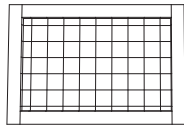

⑨

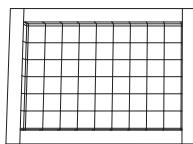

⑩

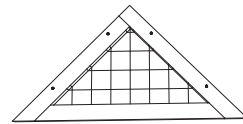

⑪ x2

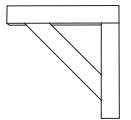

⑫ x4

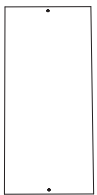

⑬ x3

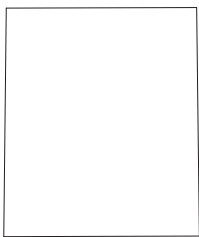

⑭ x4

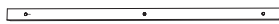

⑮ x4



⑯ x2

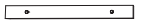

⑰ x2

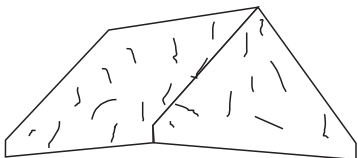

⑱



⑲

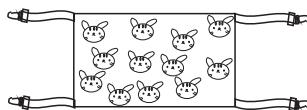

⑳

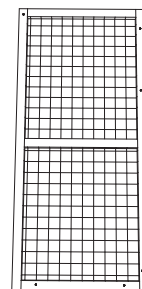

㉑

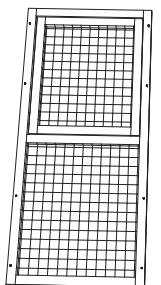

㉒

STEP 1

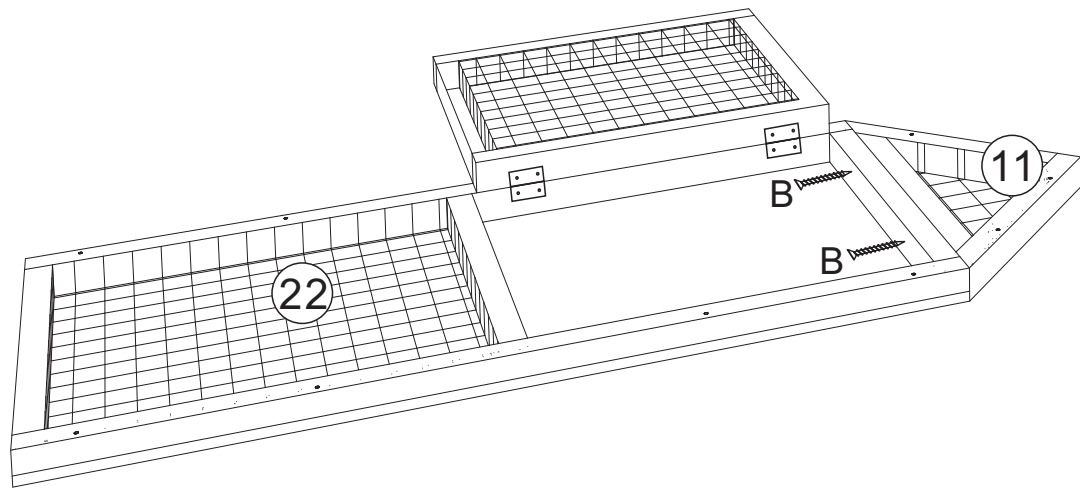

Bx2

STEP 2

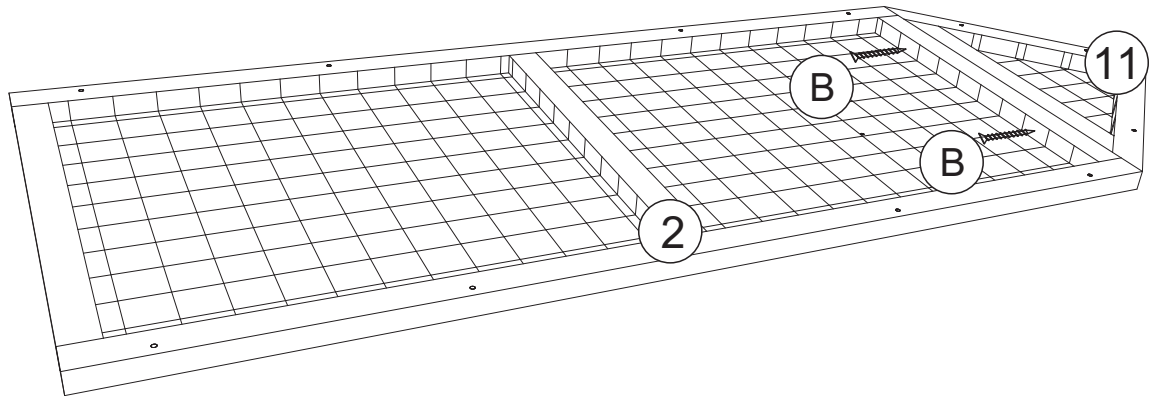

Bx2

STEP 3

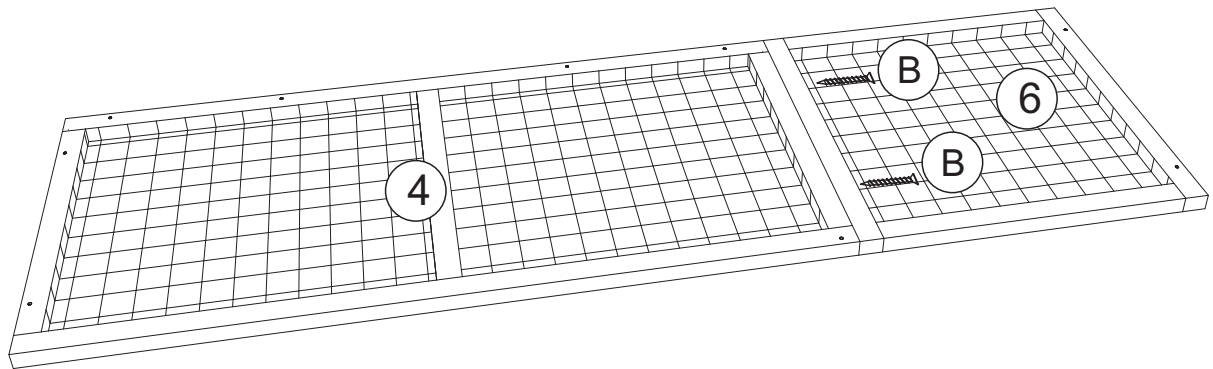

Bx2

STEP 4

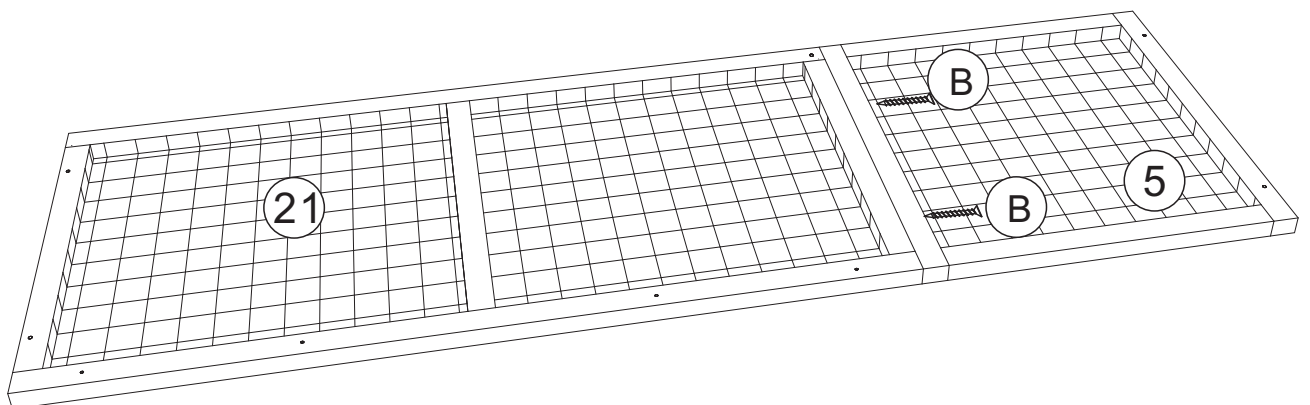

Bx2

STEP 5

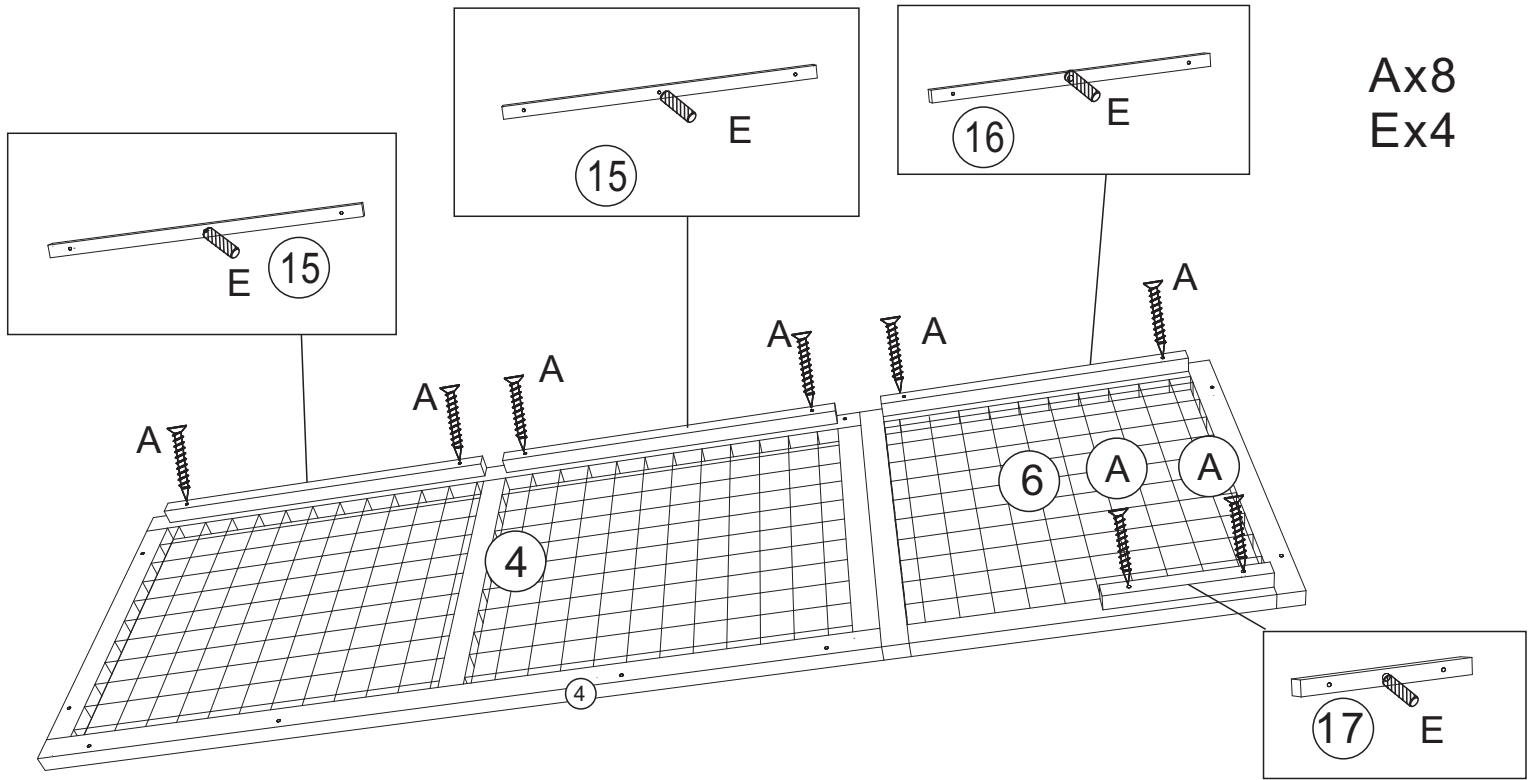

STEP 6

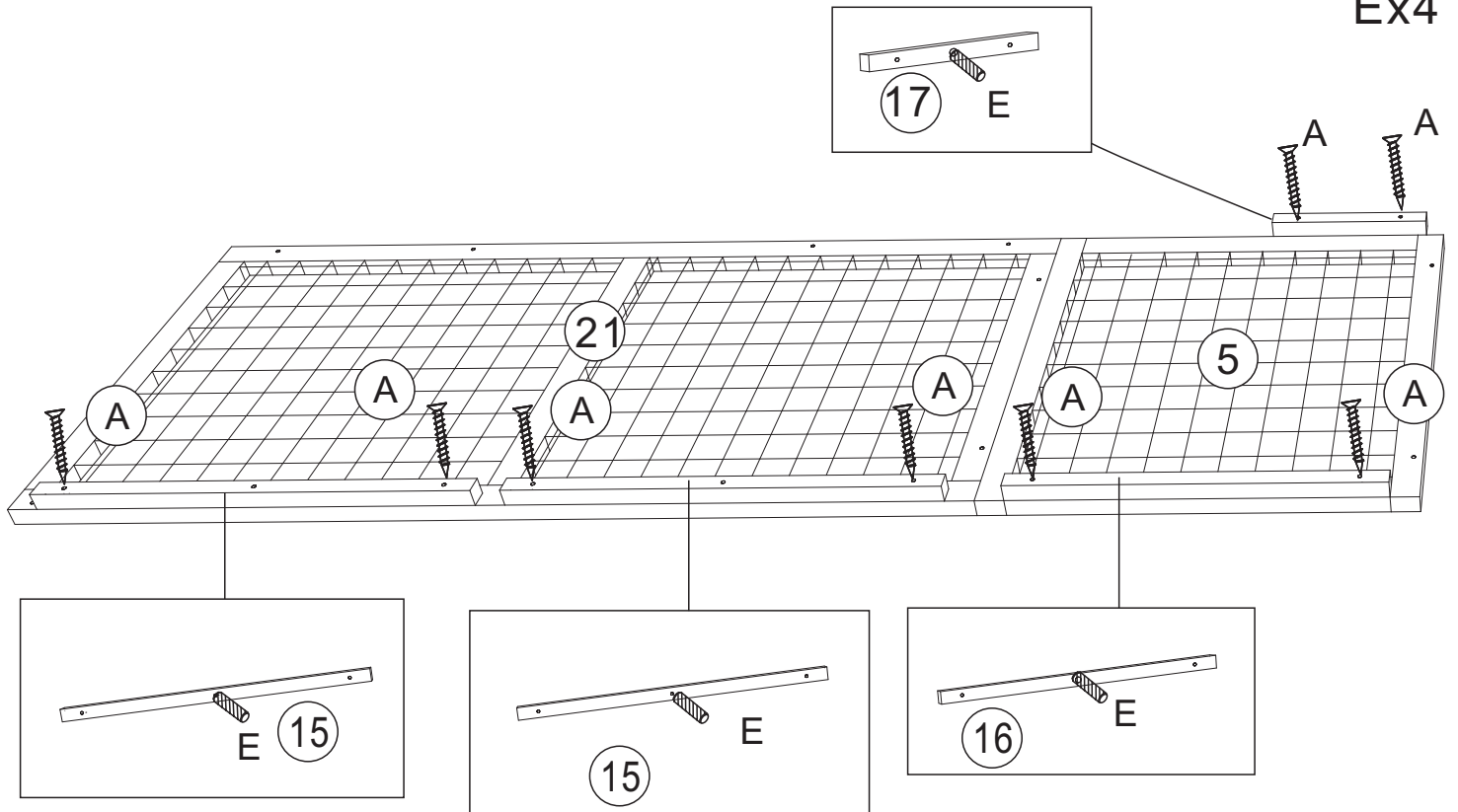

STEP 7

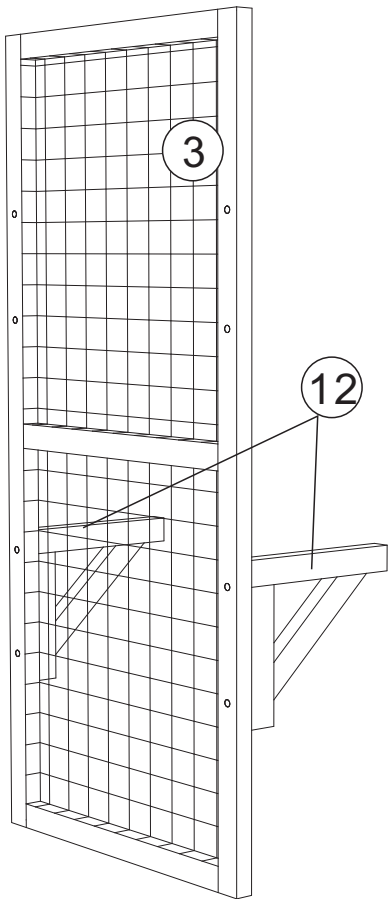
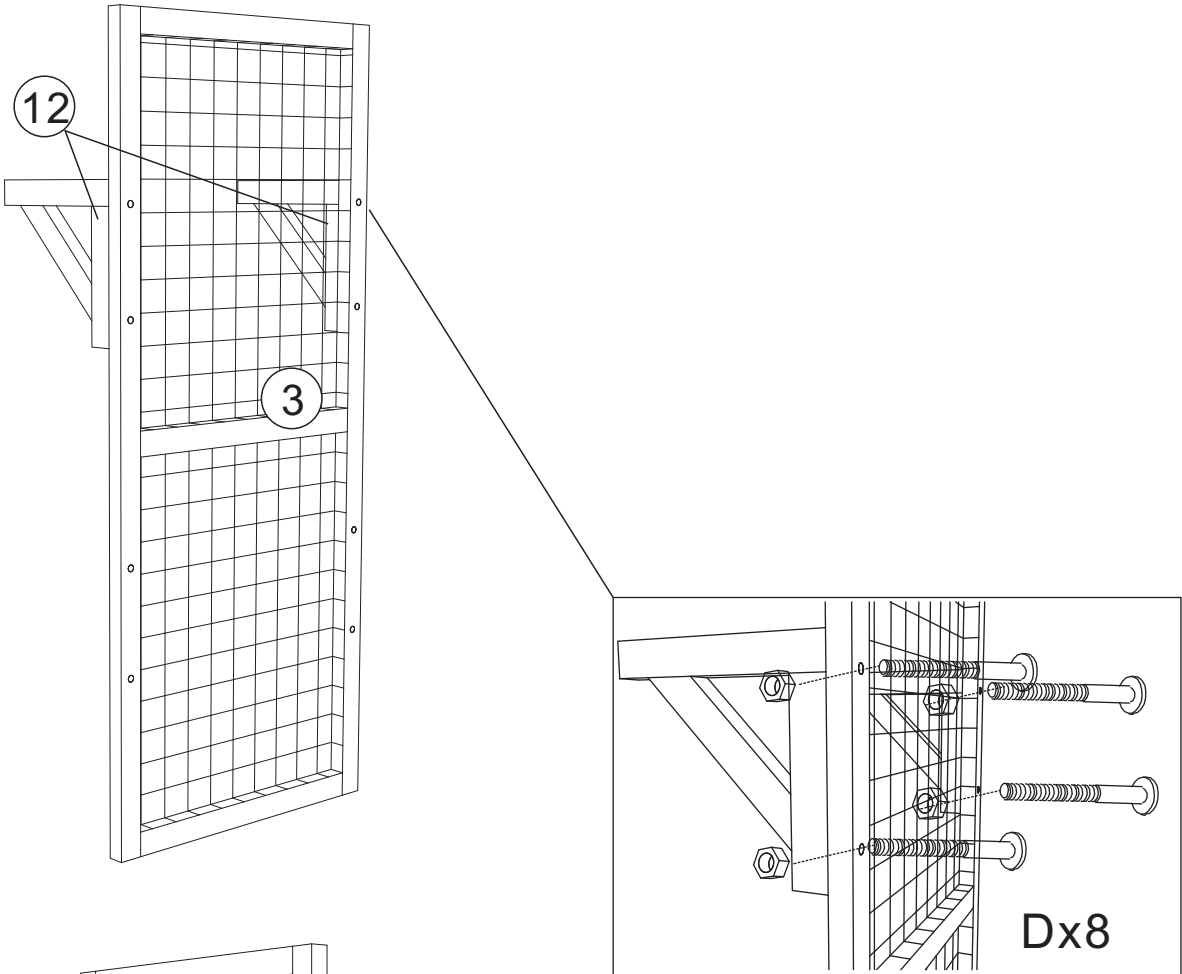

STEP 8

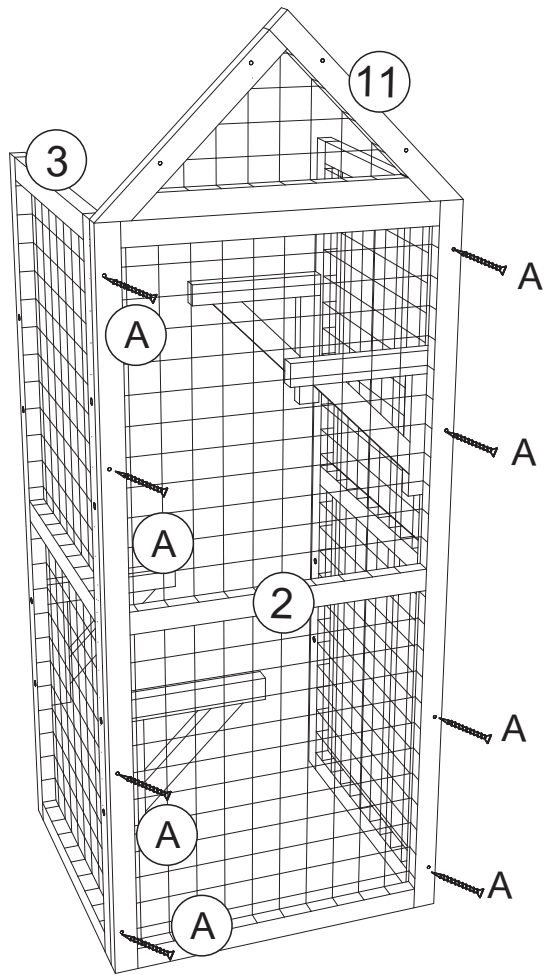

Ax8

STEP 9

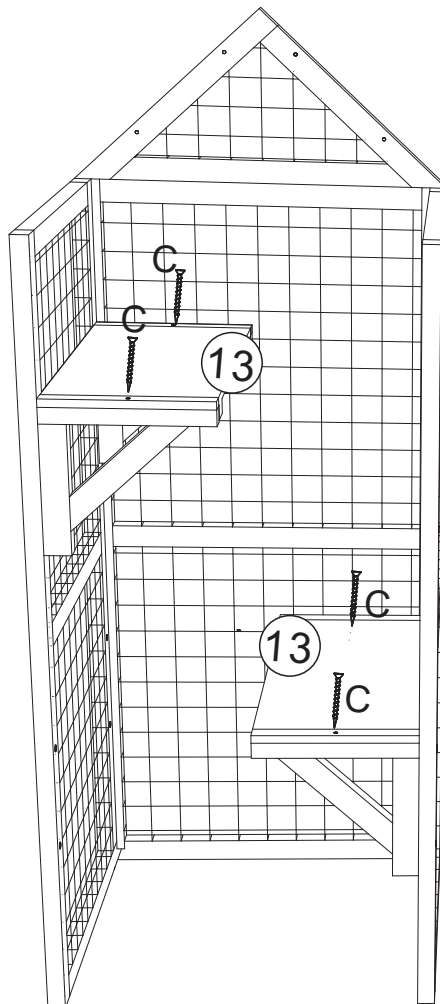

Cx4

STEP 10

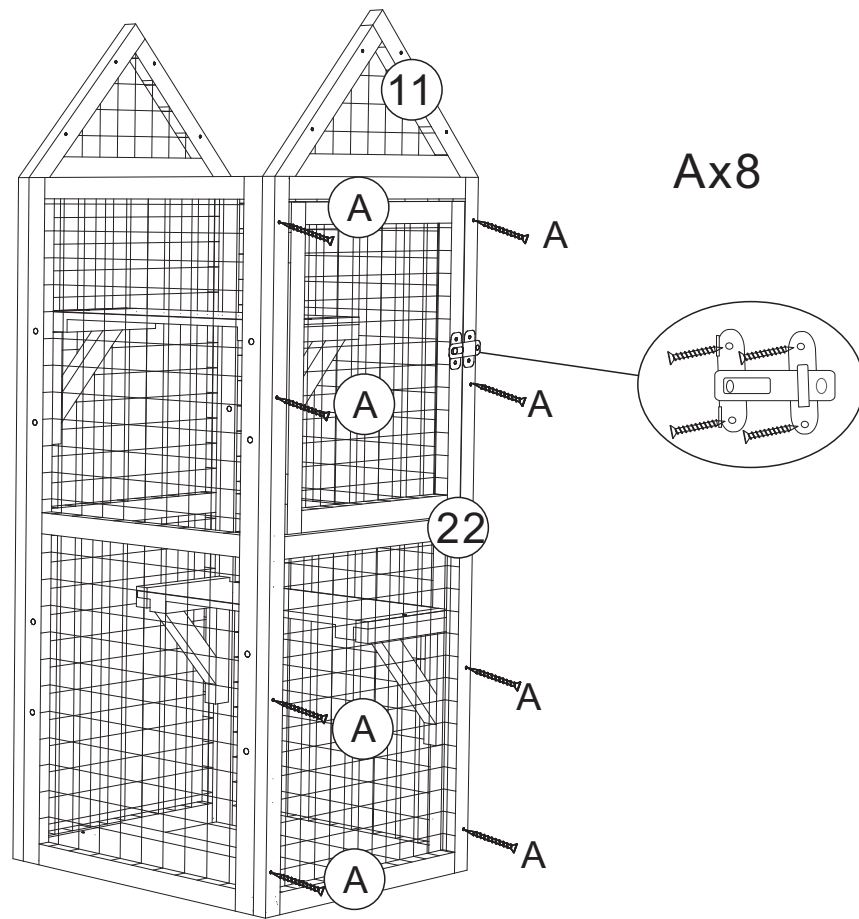

STEP 11

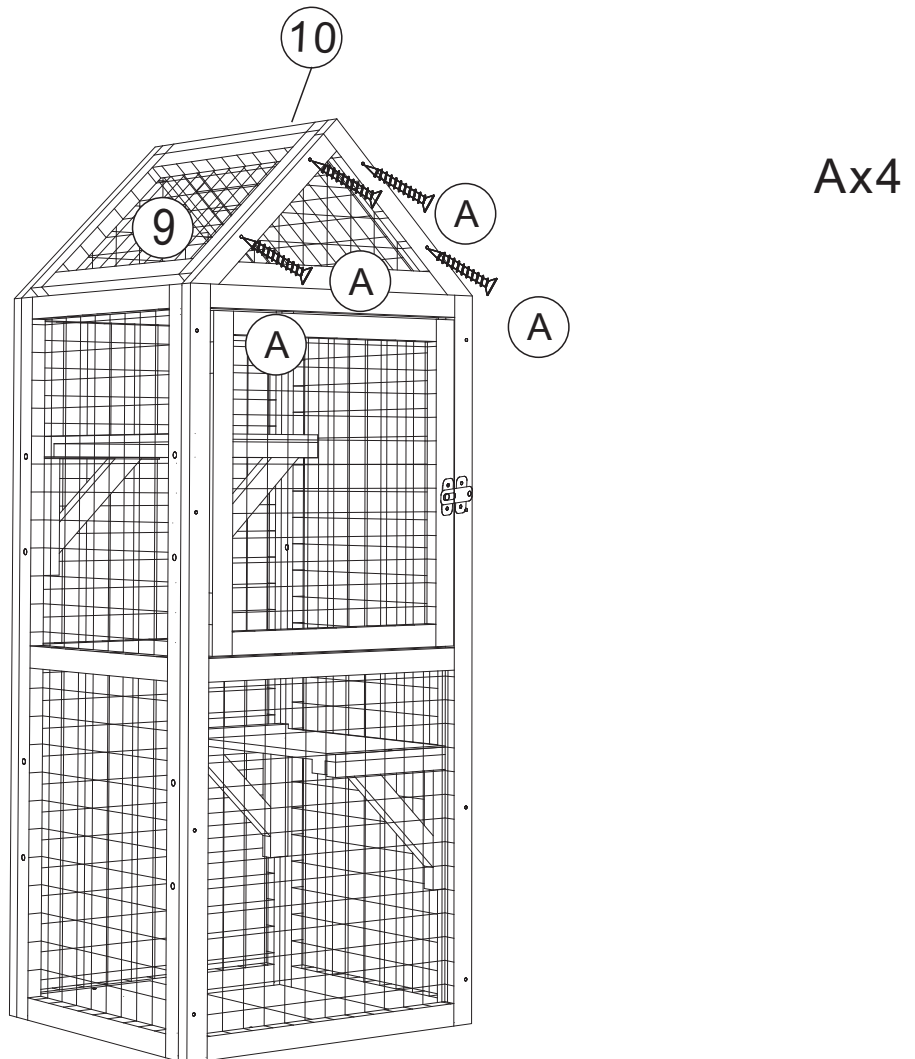

STEP 12

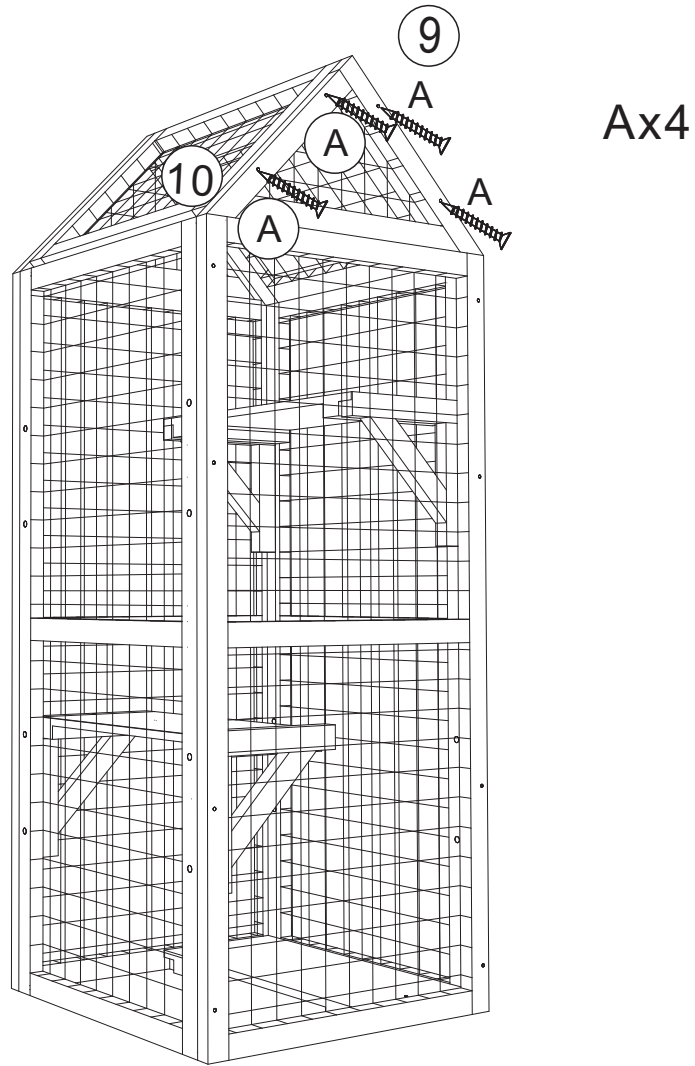

STEP 13

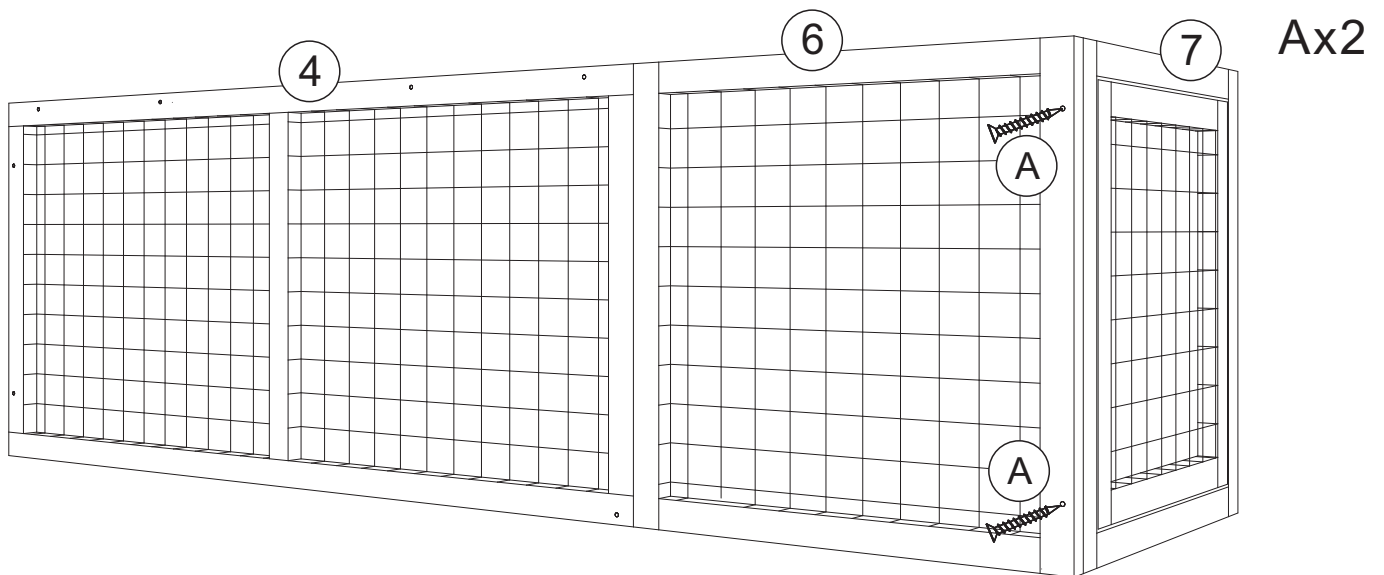

STEP 14

Ax2

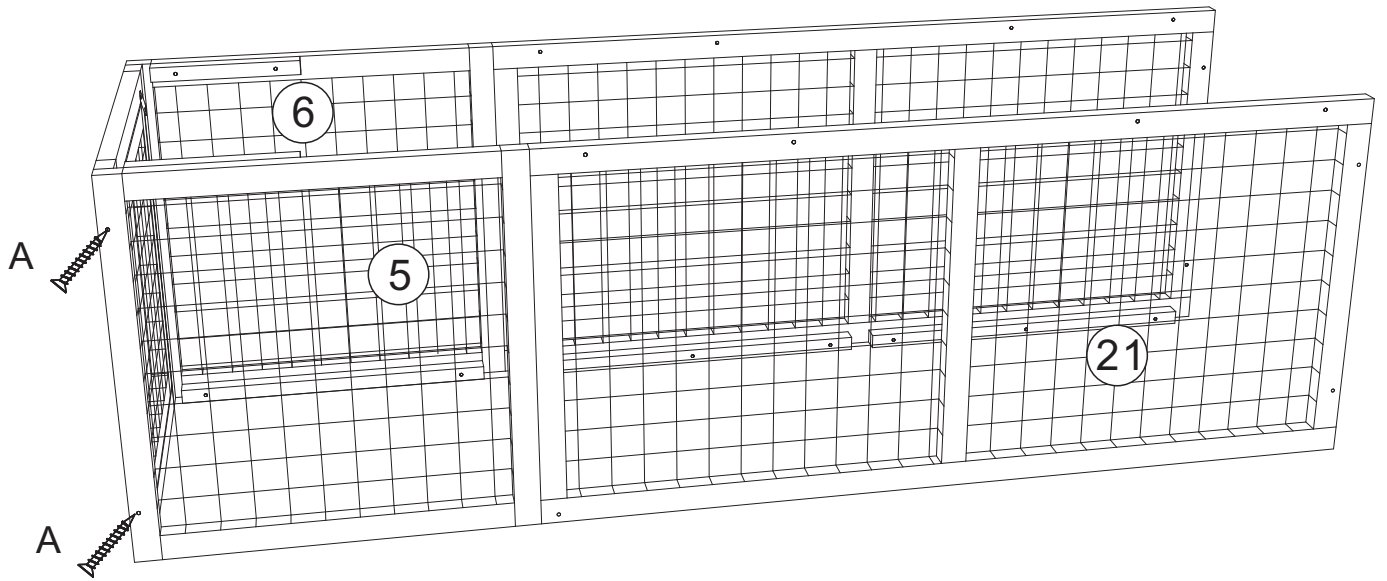

STEP 15

Bx2

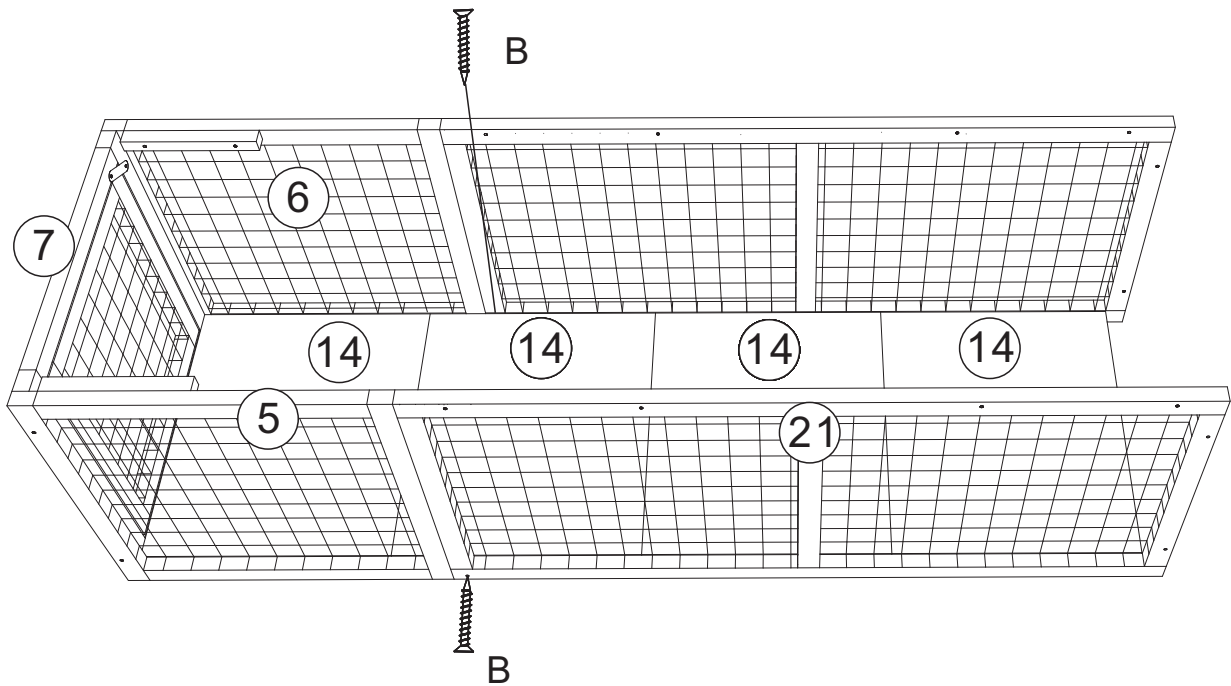

STEP 16

Cx2

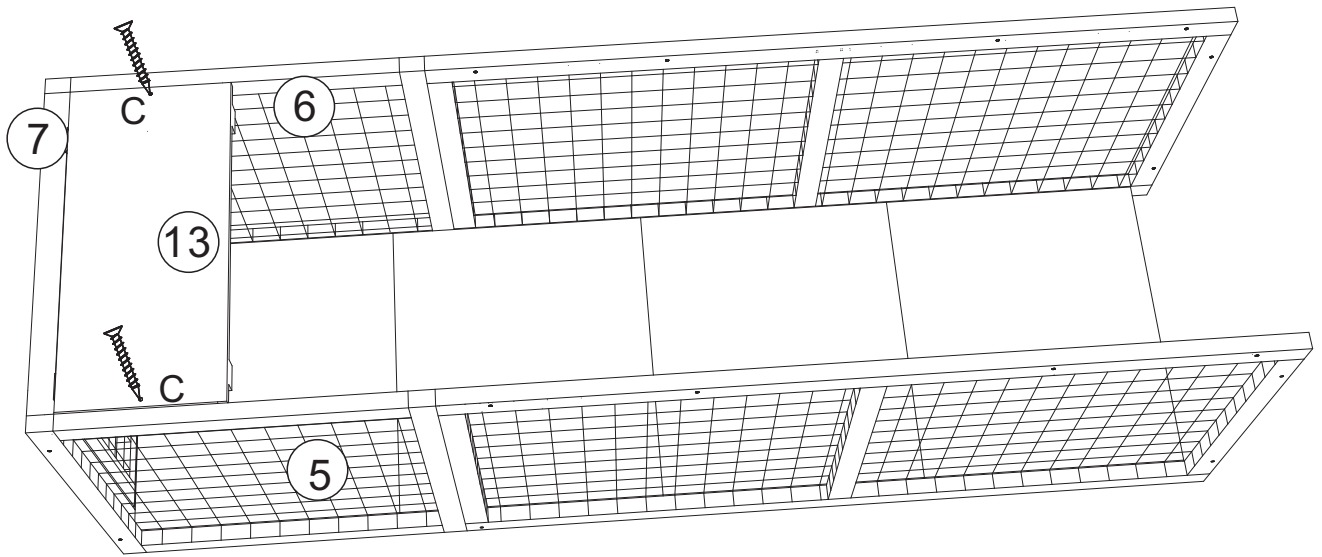

STEP 17

Ax4

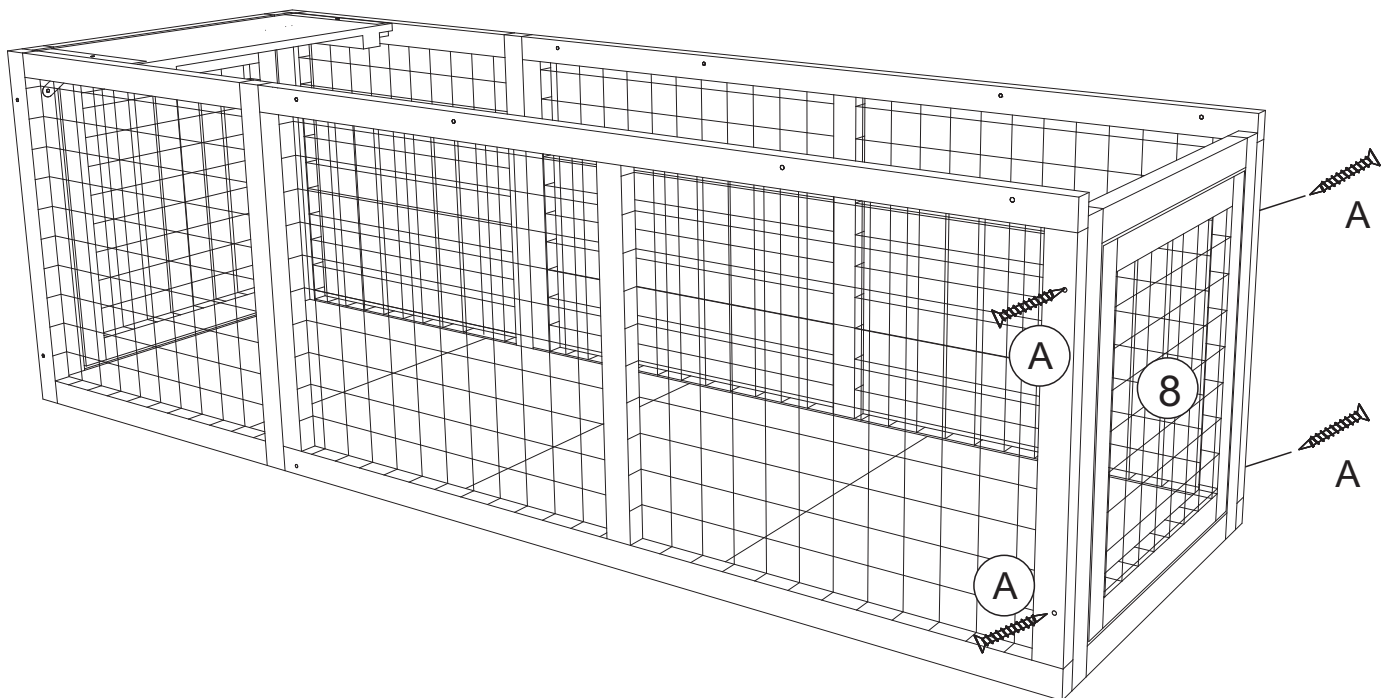

STEP 18

Ax8
Gx4

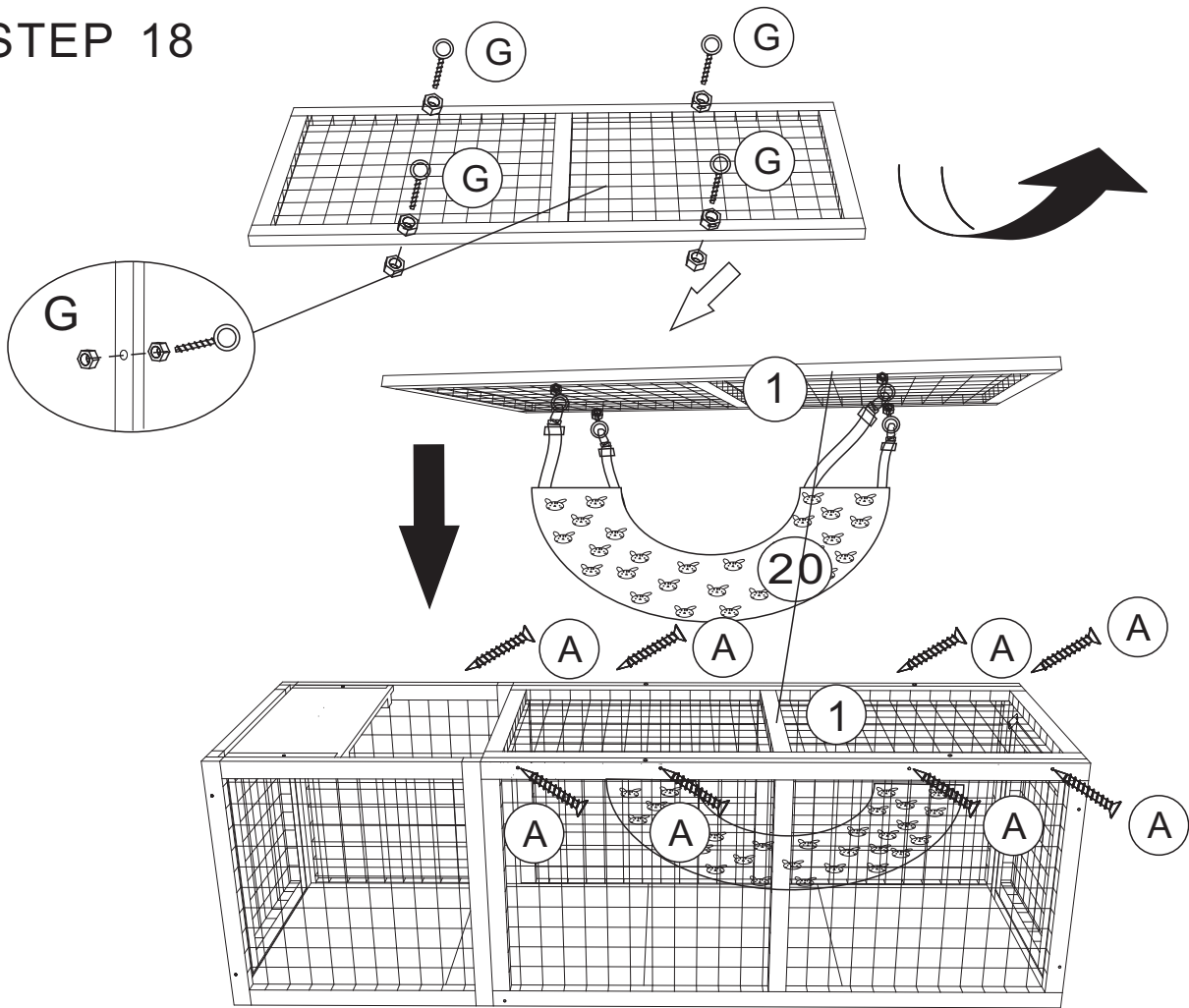

STEP 19

Bx2

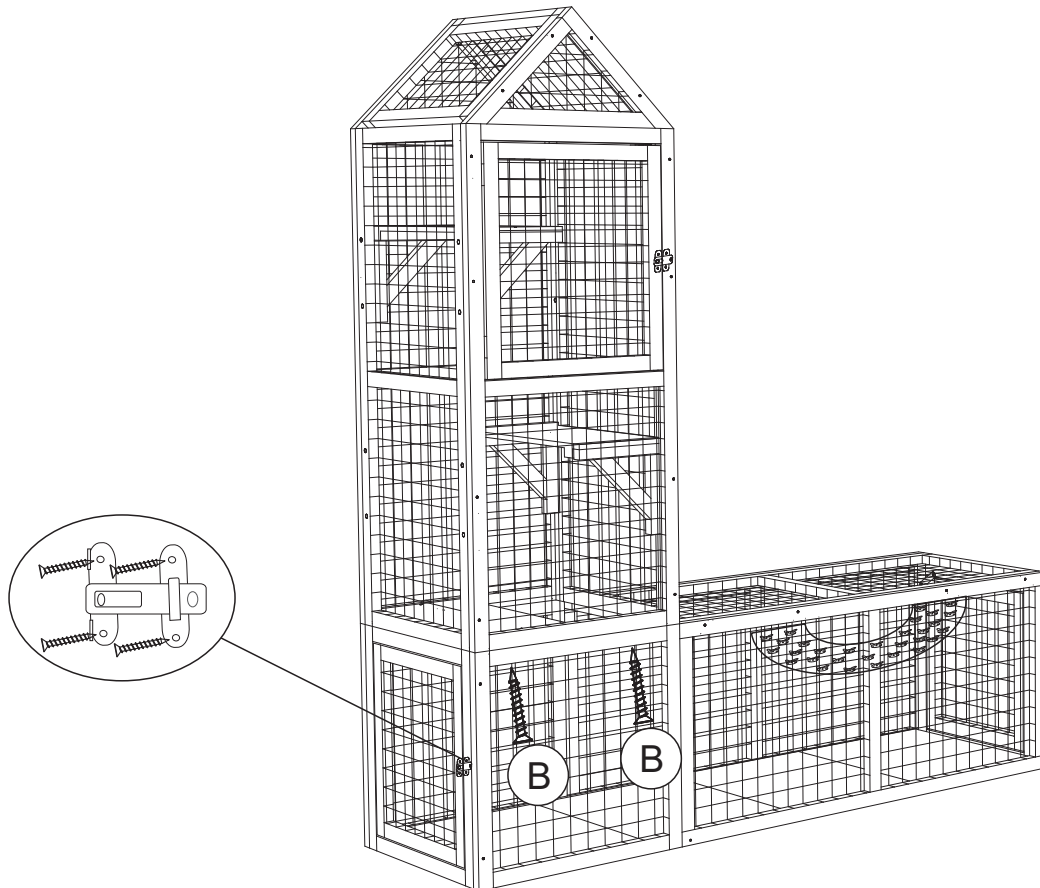

STEP 20

Bx2

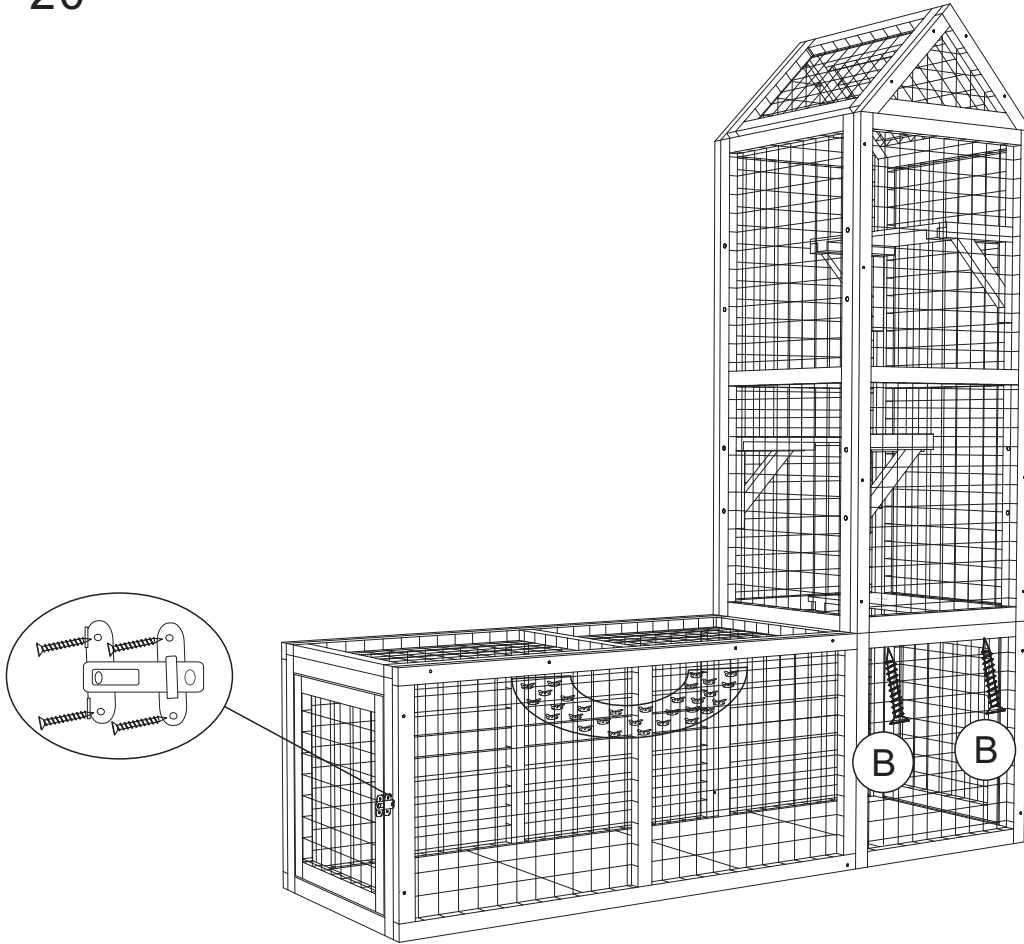

STEP 21

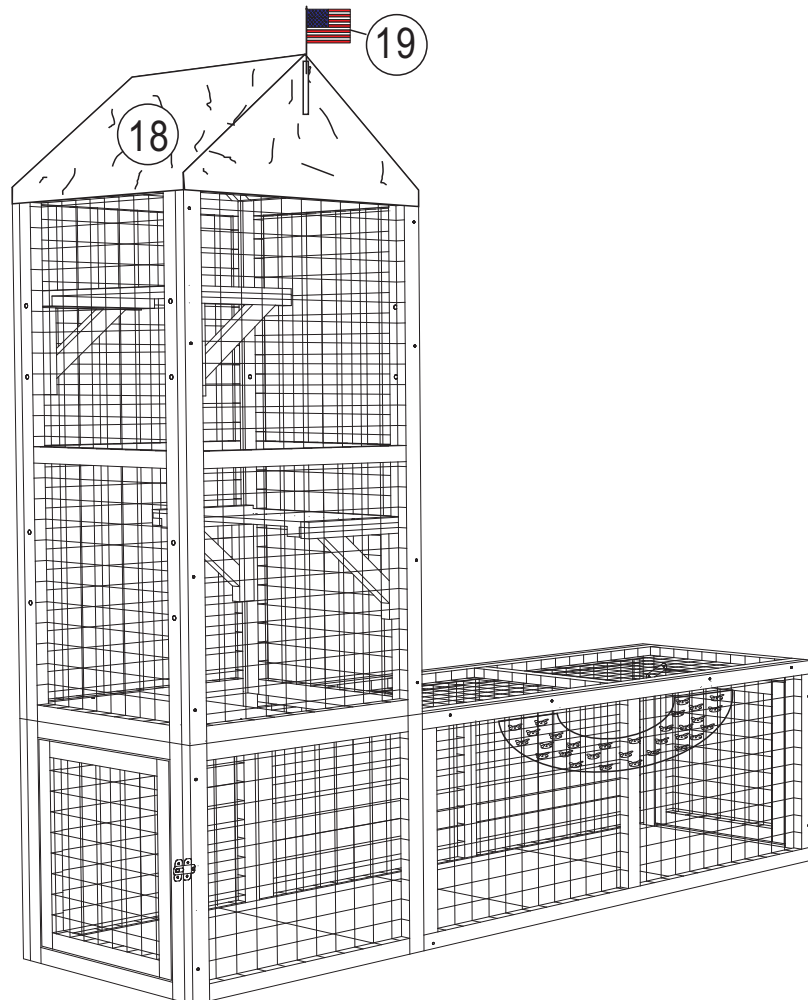

STEP 22

Attention: The following steps are applicable for assembling this channel with the corresponding cat cage

Bx2

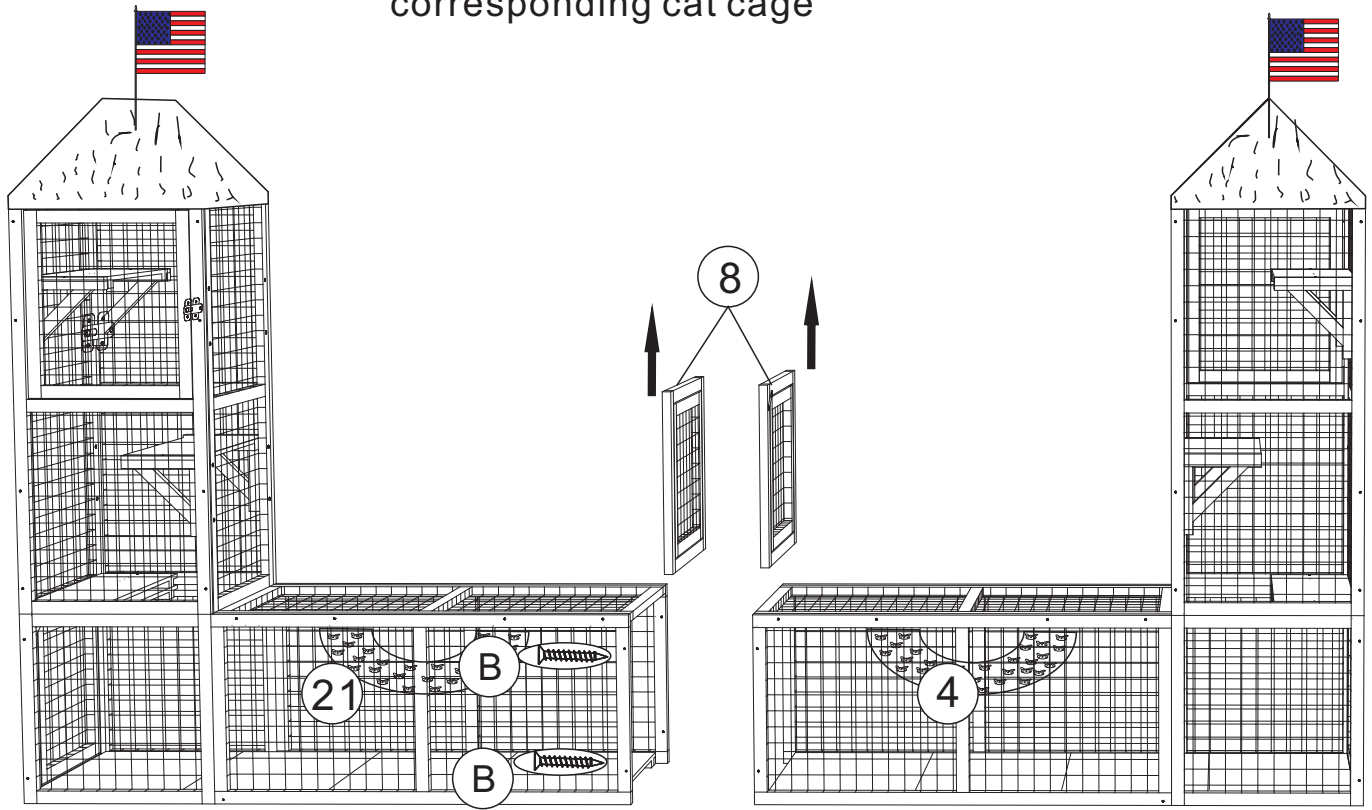

STEP 23

Bx2

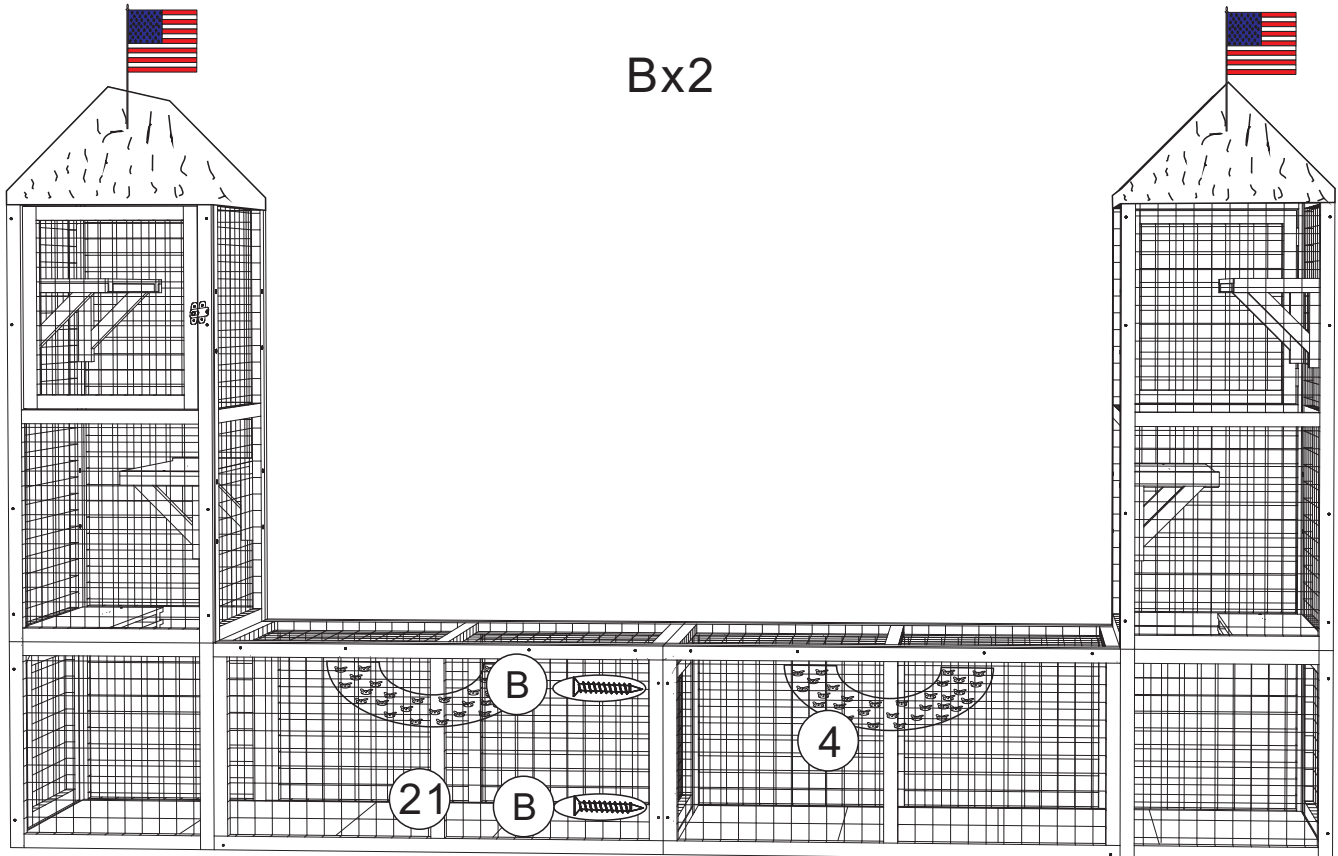

STEP 24

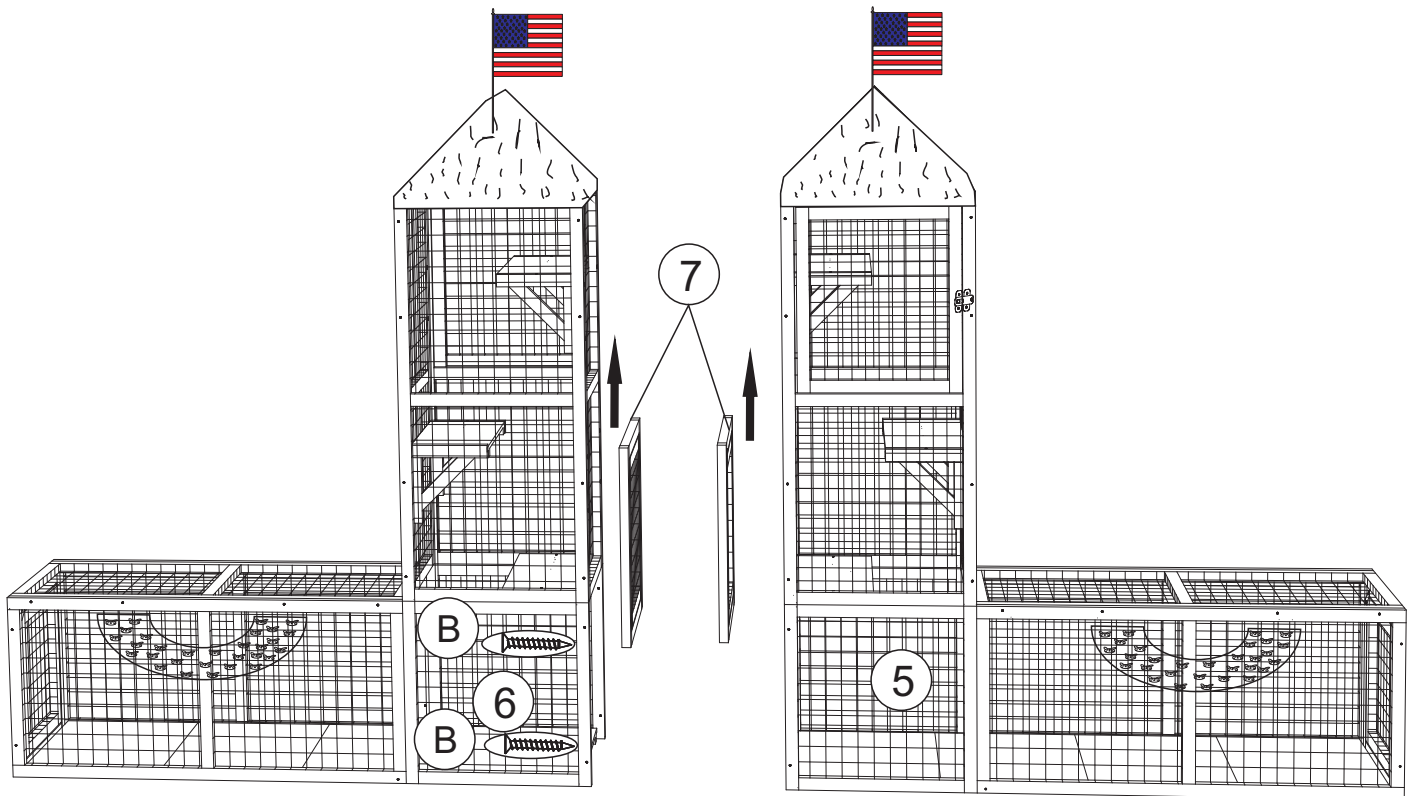

STEP 25

