







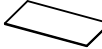

NO	Part Name	Part Picture	Quantity
1	Bottom cabinet		1
2	Top chese		1
3	Rubber Mat		1
4	2.5-inch rubber caster		2
5	2.5-inch rubber caster with brake		2
6	Handle		1
7	M6X16 Screw		4
8	Hook		4
9	Wrench		1

Assembly Step

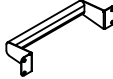

STEP 1:
Open the package, put down the tool cabinet, remove the 4 pieces M8 screw from the bottom of the cabinet

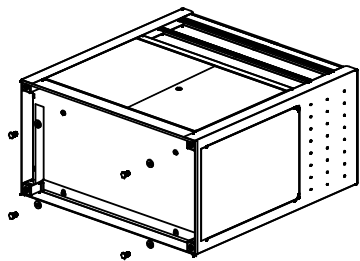
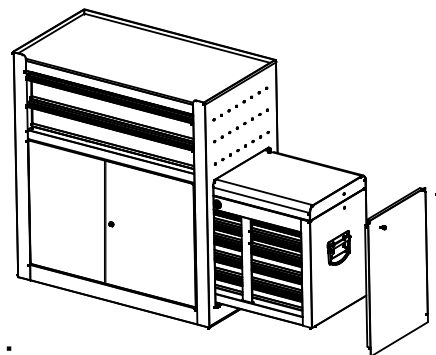

STEP 2:
Stand the tool cabinet up, then remove the M4 screw of the side door (please keep these 2 screws), take out the top chest from the tool cabinet, then assemble the side door as before.

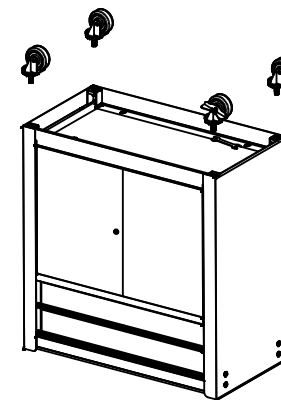

STEP 3:
Turn the tool cabinet upside down, as the picture, using wrench to assemble the casters, the brake caster need to keep one side with handle

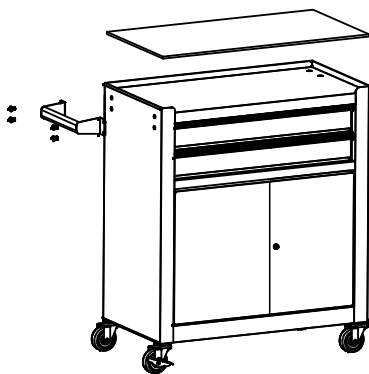

STEP 4:
Using M6*16 screw to assemble the handle, keep handle and brake caster in one side

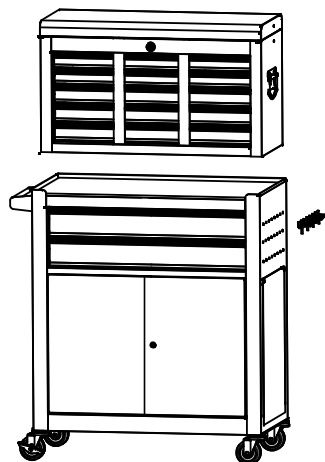

STEP 5:
Assemble the hook, then put the top chest on the tool cabinet

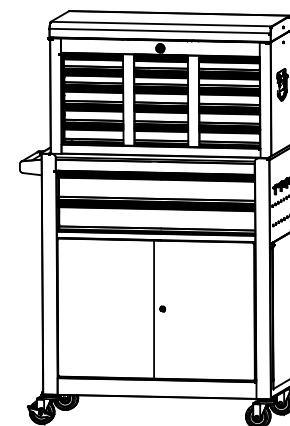

STEP: Assembly complete