

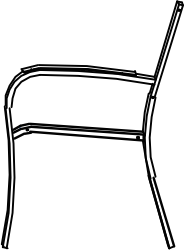

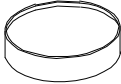

<p>A</p>	 <p>X 1</p>	<p>H</p>	 <p>X 8</p>
<p>B</p>	 <p>X 1</p>	<p>I</p>	 <p>X 1</p>
<p>C</p>	 <p>X 1</p>		
<p>D</p>	 <p>X 1</p>		
<p>E</p>	<p>M6*45</p>  <p>X 4</p>		
<p>F</p>	<p>M6*30</p>  <p>X 4</p>		
<p>G</p>	 <p>X 8</p>		

1

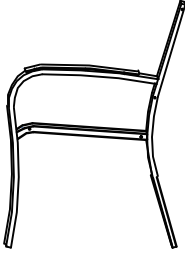

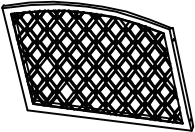
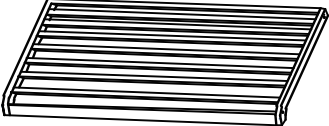
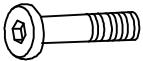
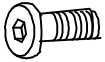
2

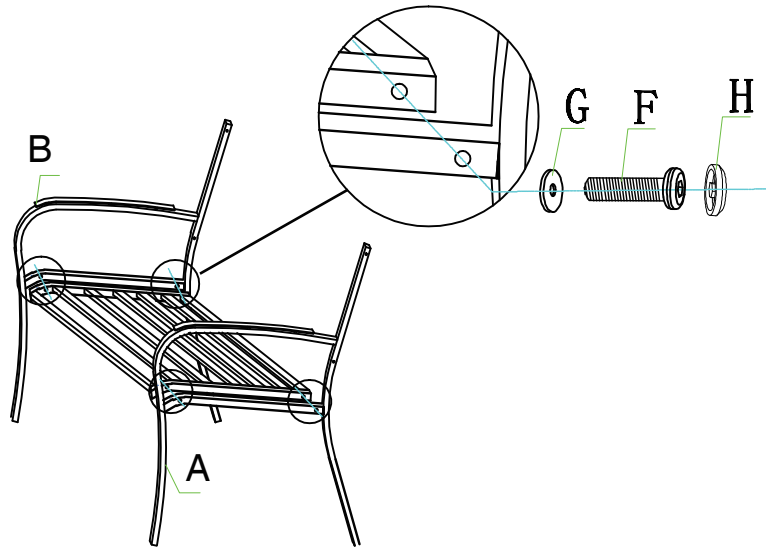
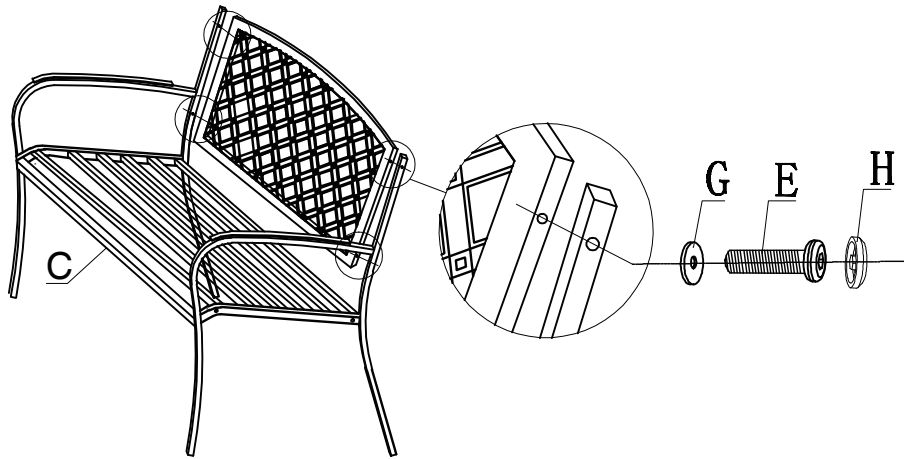

3

