

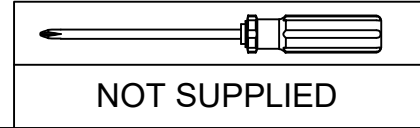







CVFVR8320-ASSEMBLY INSTRUCTIONS

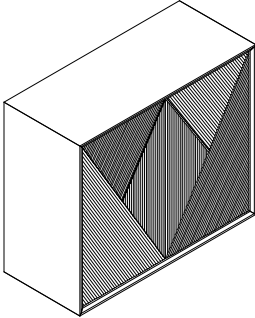
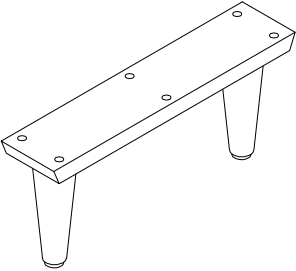
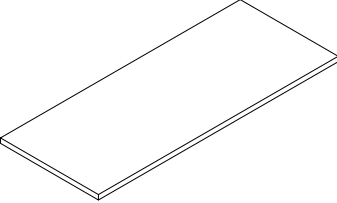

NOT: REQUIRED ANTI TIP KIT BEFORE USING THE PRODUCT



PARTS LIST

No	Hardware List		Q'ty	A x 1	B x 2	C x 1
1		Bolt 1/4"-20x30mm	12			
2		Flat washer 1/4"	12			
3		Spring washer 1/4"	12			
5		Allen key 4mm	1			
6		Laminate pad	4			
7		Anti-tip kits	1			

STEP: 1

1	2	3
		
12PCS	12PCS	12PCS

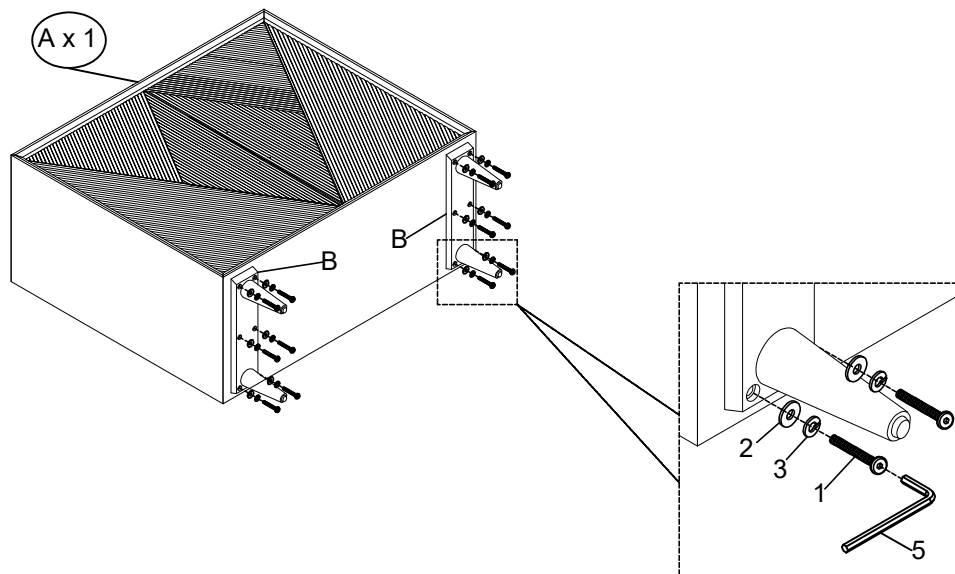

STEP: 2

6

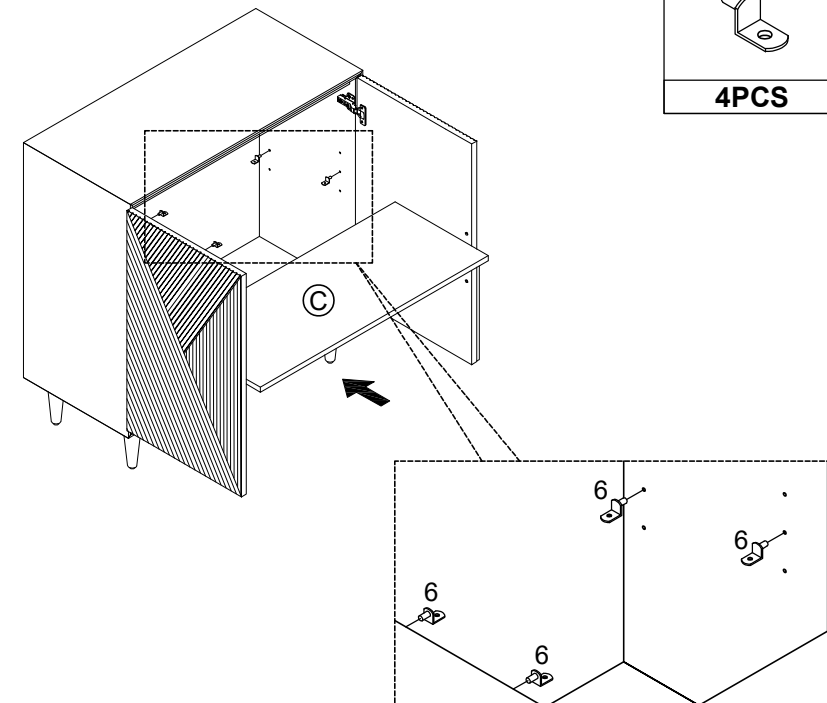
4PCS





Crestview Collection

CVFVR8320-ASSEMBLY INSTRUCTIONS

NOT: REQUIRED ANTI TIP KIT BEFORE USING THE PRODUCT

STEP: 3

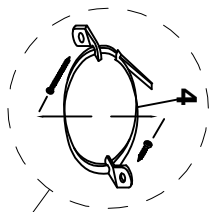

Wall

7

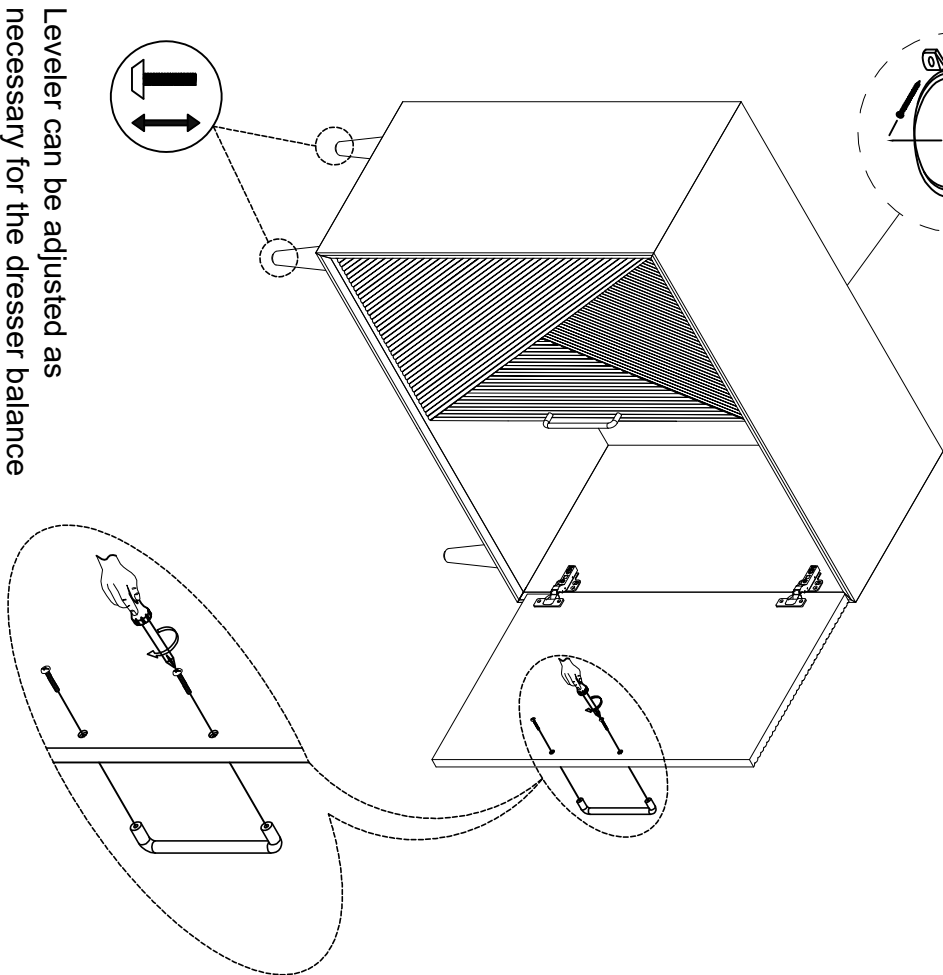
1 Set

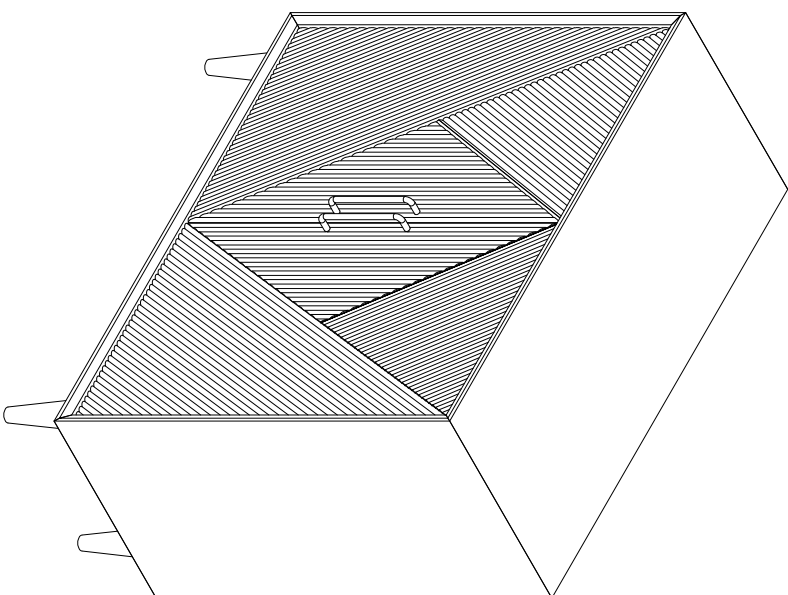

Leveler can be adjusted as necessary for the dresser balance

STEP: 4



FINISH

