











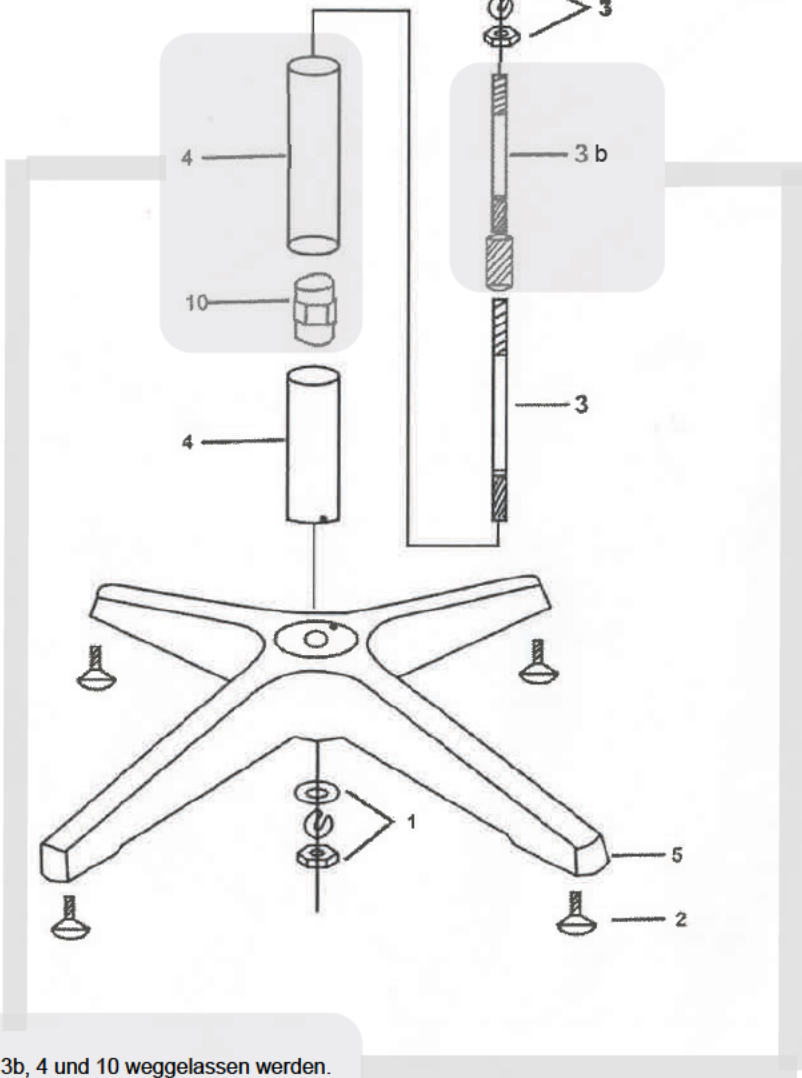

Nr.	Teile	Menge
1		2
		2
		2
2		4
3/3b		2
4		2
5		1
6		1
7		1
8		1
9		1
10		1

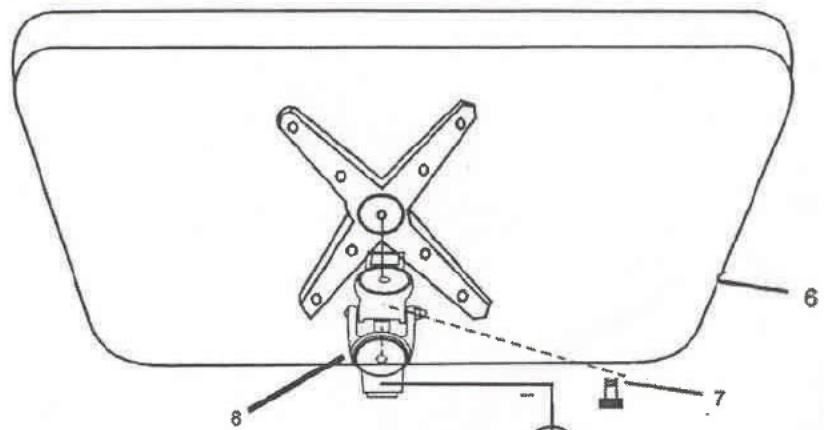

Der Bistrotisch ist in zwei Höhenstufen nutzbar
 Für eine Aufbauhöhe von 70 cm können die Teile 3b, 4 und 10 weggelassen werden.

Für eine Aufbauhöhe von 110 cm müssen alle Teile genutzt werden.