

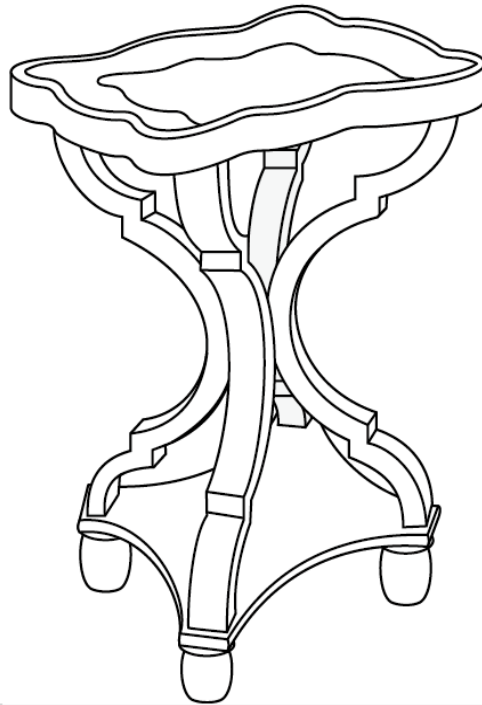



Assembly Instructions

Caution : You must read this before you proceed

End Table









Parts List

Label	Picture	Description	QTY
A		Table Top	1
B		Leg	3
C		Protruding Leg	1

D		Shelf	1
E		Feet	4

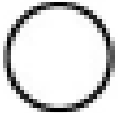
Hardware

Label	Picture	Description	QTY
①		Bolt(M6*25MM)	5
②		Bolt(M6*30MM)	4
③		Adjustable Leveller	5
④		Flat Washer	9
⑤		Resin plug	4
⑥		Allen Wrench	1

Assembly Preparation

Before Beginning Assembly :

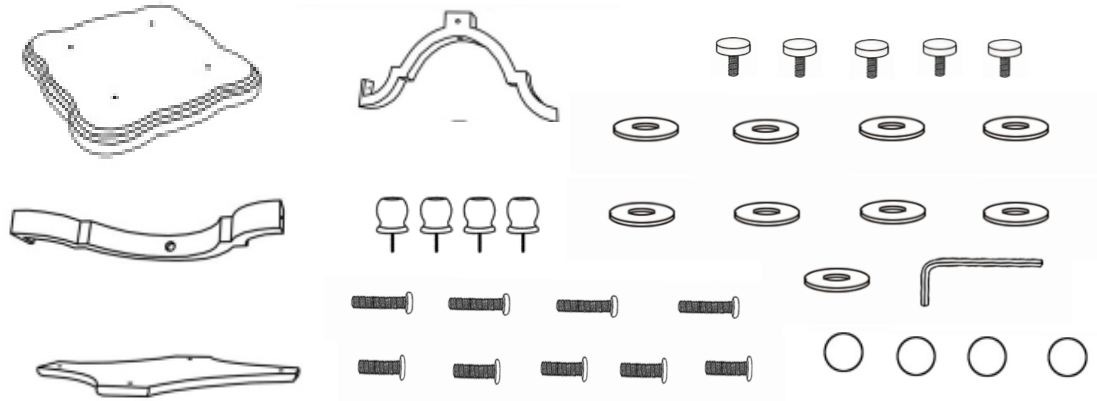

- Read instructions, cover to cover-



- Have 2 adults on hand for assembly-



- Do not assemble on flooring or carpet-



- Assemble on a clean non-marring surface (packing foam)-



- Save all packaging until finished-

Assembly Steps

Overview

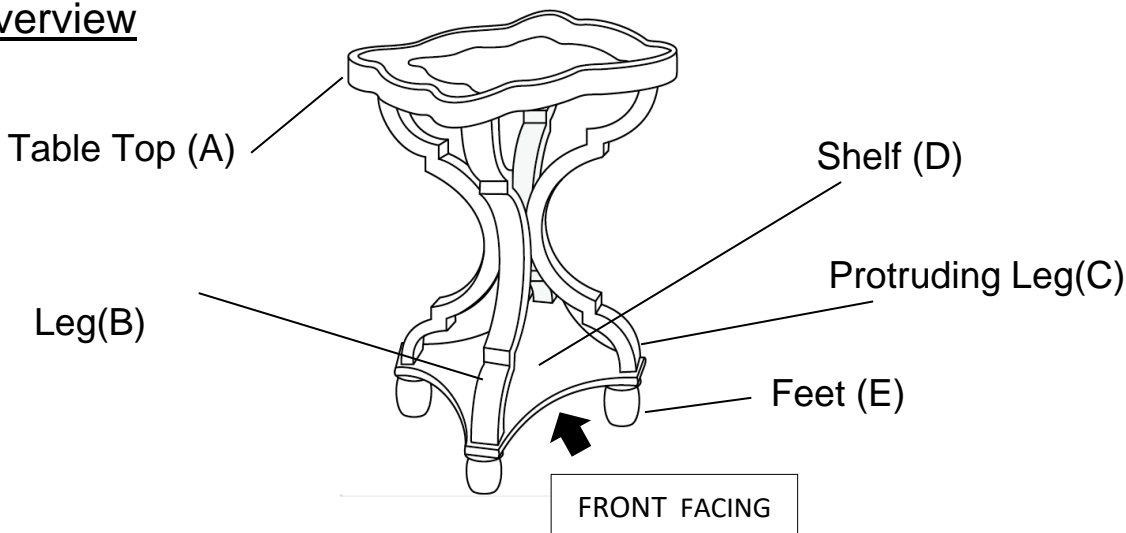

This End Table has multiple parts and may require up to some 30 minutes to assemble.

To give you an overview of the End Table parts, the above picture is to help you put the various parts into perspective.

Please read through the instructions herebelow to familiarise the parts and steps before assembly.

Step 1

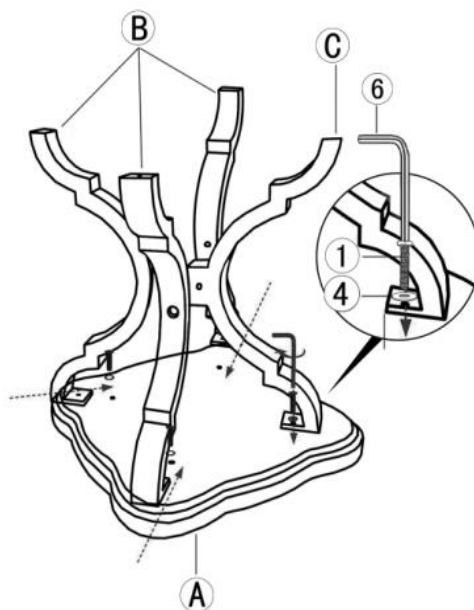

Place the Table Top(A) on a clean, non-marring surface, facedown.
Attach Leg(B) and Protruding Leg(C) to the Table Top(A) using Bolt(①) and Flat Washer(④) with Allen Wrench(⑥) as shown.

Step 2

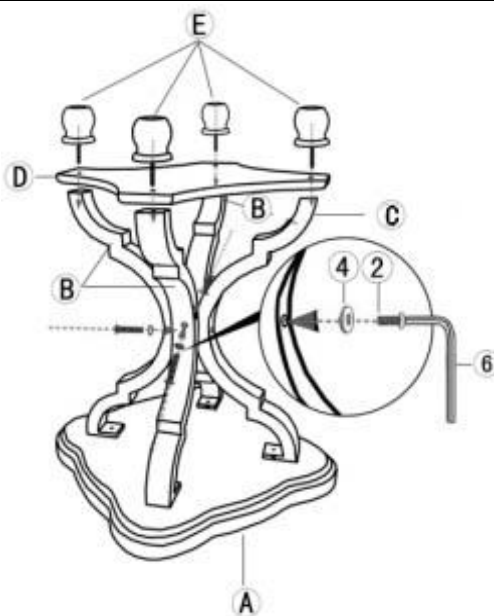

Align the mountings in the middle of Leg(B) to Protruding Leg(C). Using Bolt(②) and Flat Washer(④) with Allen Wrench(⑥)

Attach the Shelf(D) over the end of the Leg(B) and Protruding Leg(C), slightly adjust the Leg(B) and Protruding Leg(C) so the screw holes on the Leg(B) and Protruding Leg(C) are lined with the holes on the Shelf(D).

Slightly screw the Feet(E) one by one through the Shelf(D) to connect with the Leg(B) and Protruding Leg(C).

Step 3

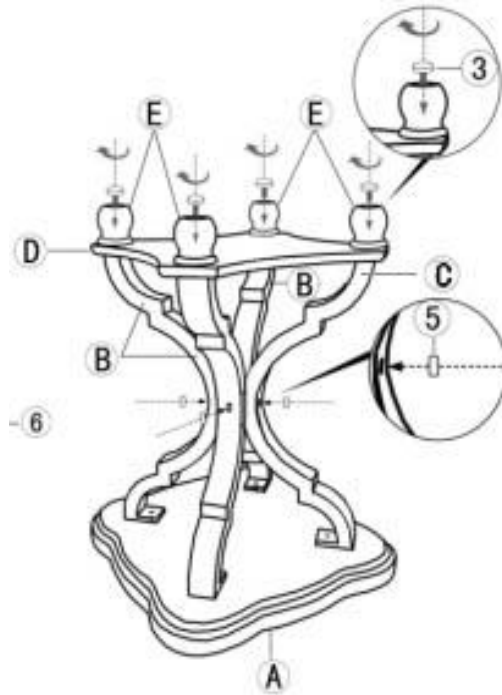

Attach Adjustable Leveller(③) to the Feet (E) by hand.
Attach Resin plug(⑤) to the middle of Leg(B) and Protruding Leg(C) by hand.

Step 4

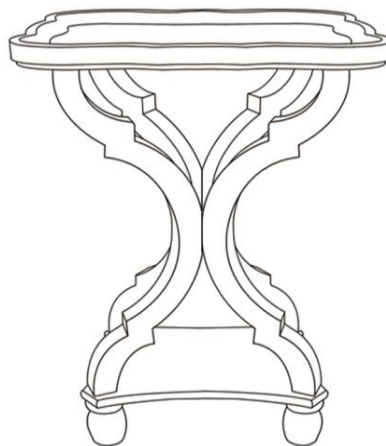

Turn the End Table right side up.
Your End Table is ready for use.
Caution: This End Table can only be used on a flat, level surface.

Care & Maintenance



- Furniture may scratch floors. We recommend using furniture pads to protect your floors.



- Do not put hot items directly on furniture surface.



- Do not clean furniture with harsh cleansers or polish.



- Do not place furniture under direct sunlight.



- Do not place furniture near heating or cooling vents.



- Do not write on furniture without a padded barrier to protect the surface.



- Do not place furniture outside . For indoor use only.



- Not for commercial use. For residential use only.



- Stains may be removed with mild soap solution and damp cloth.



- Children should not climb or jump on the furniture.



- Dust and pick-up spills using a clean, non-colored, lint-free cloth.