







ASSEMBLY INSTRUCTIONS

Please follow the assembly instruction carefully step by step . Place all wooden parts on a clean and flat surface such as carpet or rug to avoid the part from being scratched. Make sure the barstool does not wobble before use. Keep all hardware out of reach of small children.

			QTY.
A	ALLEN KEY		1
B	JCBC SCREW M6 x 80MM		4
C	JCBC SCREW M6 x 50MM		4
D	JCBC SCREW M6 x 40MM		2
E	M6 x 16 / M6 x 19 FLAT WASHER		10
F	M6 x 16 / M6 x 19 SPRING WASHER		10

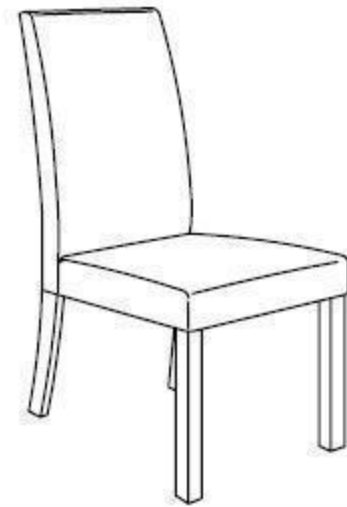

1 Screw in Cushion Seat to Backrest using JCBC Screw M6x40mm, Flat Washer & Spring Washer. Then, screw in Corner Block to leg using JCBC Screw M6x80mm, Flat Washer & Spring Washer.

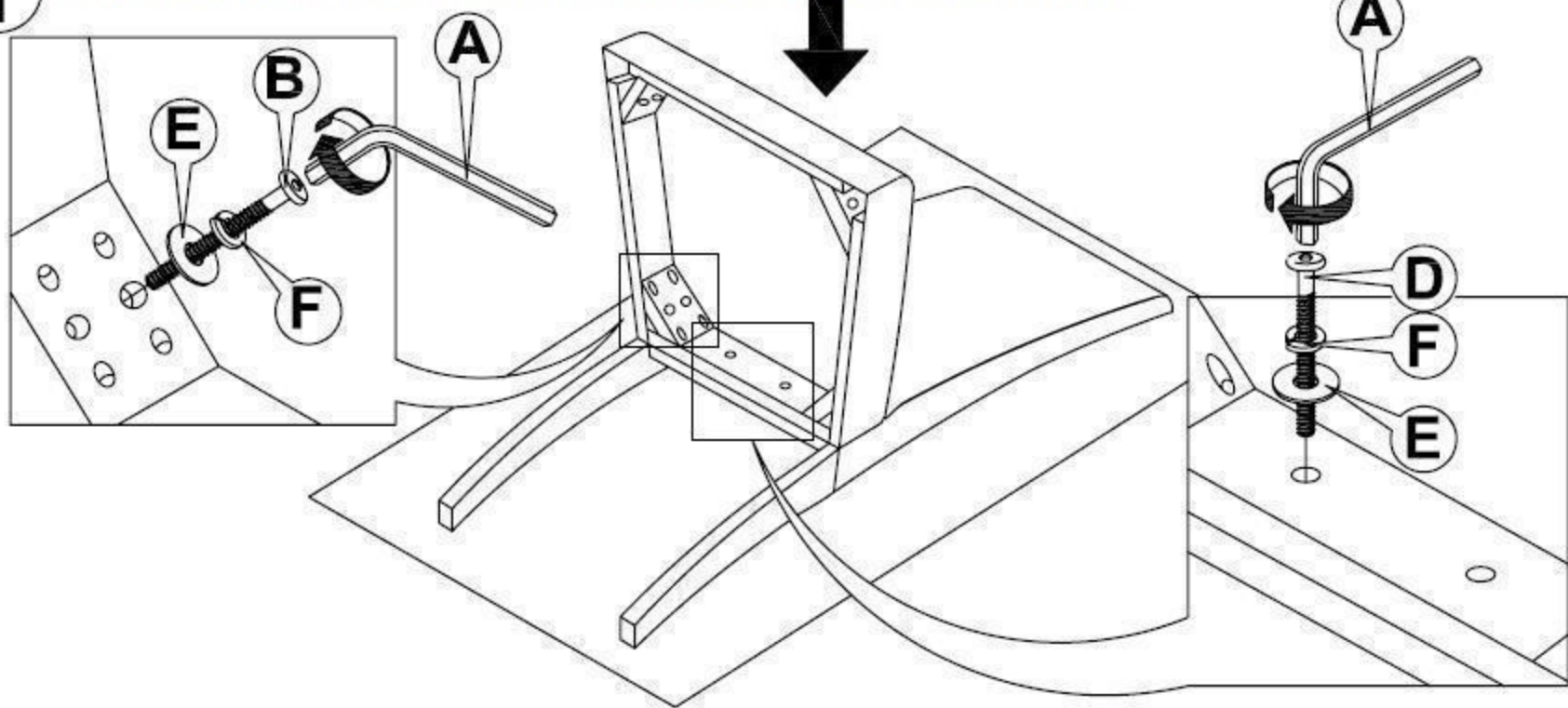

2 Screw in Chair Front Leg to Cushion Seat using JCBC Screw M6x50mm, Flat Washer & Spring Washer.

