

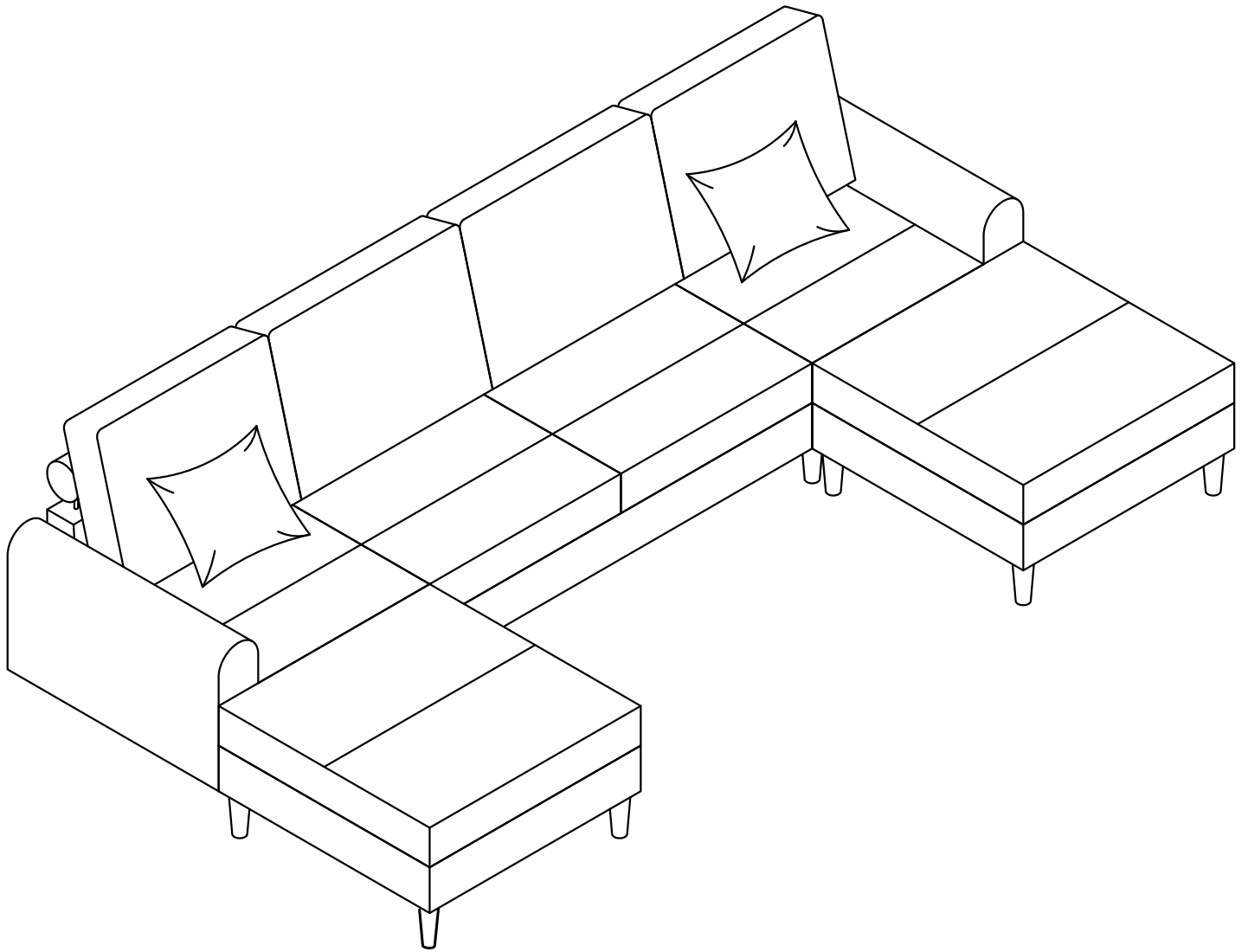















ASSEMBLY INSTRUCTION

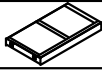







COMPONENT LIST

NO.	DRAWING	QTY	DESCRIPTION
F		1	Ottoman Frame
K		2	Loveseat Back Cushion
N		1	Ottoman Seat Cushion

NO.	DRAWING	QTY	DESCRIPTION
F		1	Ottoman Frame
J		1	Single Back Cushion
N		1	Ottoman Seat Cushion
L		1	Single Seat Cushion



NO.	DRAWING	QTY	DESCRIPTION
B		1	Loveseat Body
C		2	Loveseat Backrest
E2		1	Right Backrest
M		2	Loveseat Seat Cushion
H		20	Round Wood Legs
O		8	Flat Washer Ø5/16"
P		8	Bolt 5/16"X50mm
Q		1	Allen key

NO.	DRAWING	QTY	DESCRIPTION
D		2	Single Frame
E1		1	Left Backrest
L		1	Single Seat Cushion
J		1	Single Back Cushion
I		2	Pillow

NO.	DRAWING	QTY	DESCRIPTION
A		1	Left Arm
G		1	Right Arm

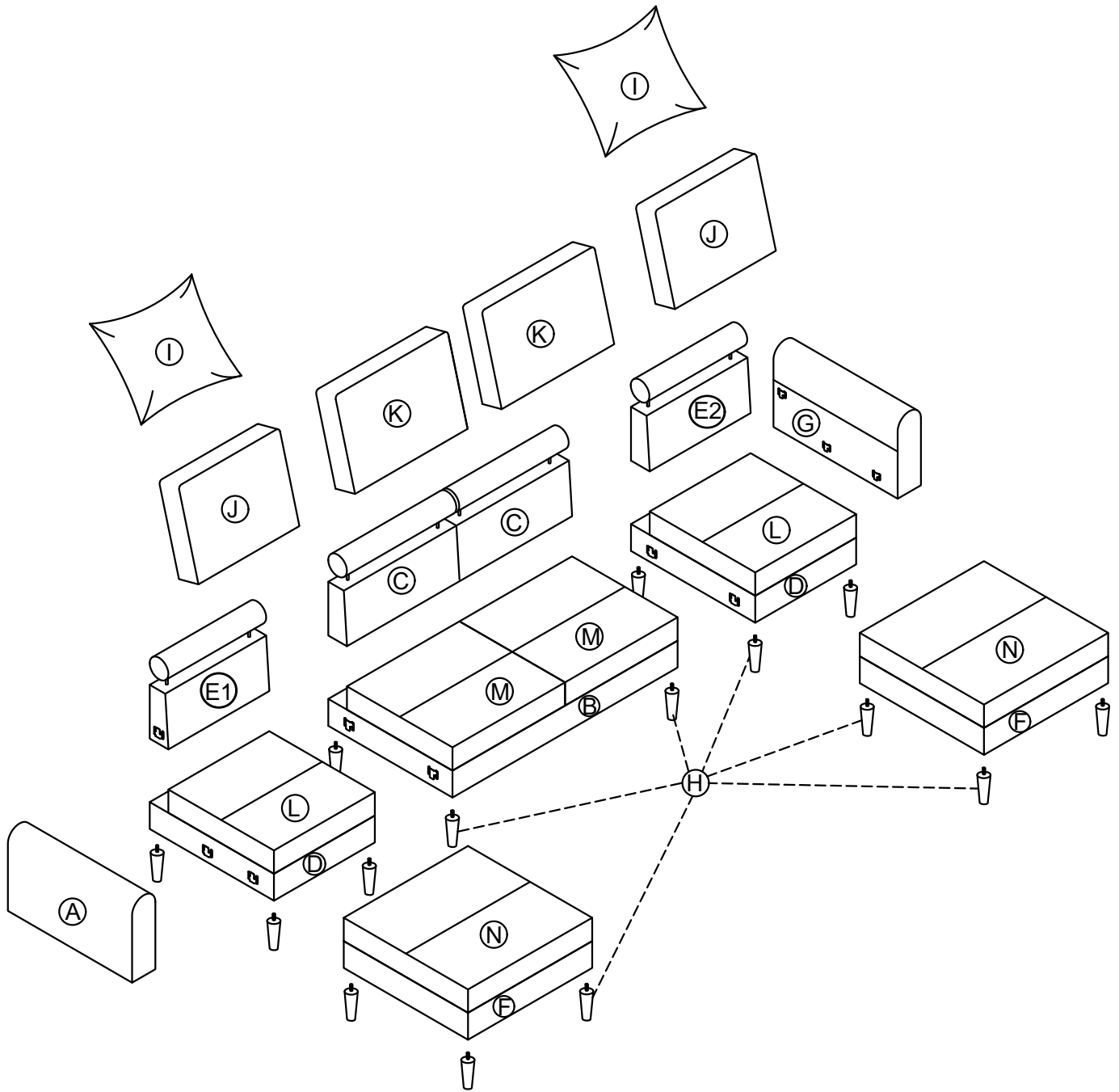
PARTS LIST

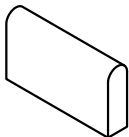
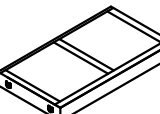
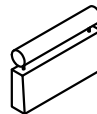
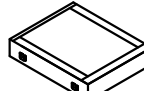
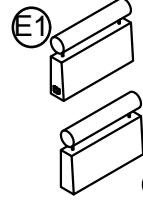
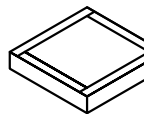
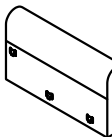
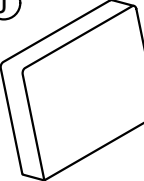

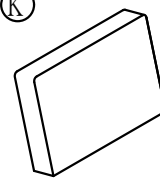
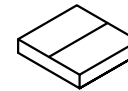
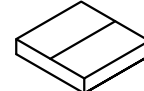
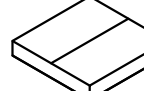
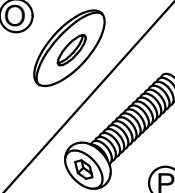
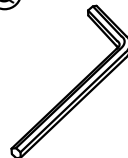
							
<p>Left Arm X 1PC</p>	<p>Loveseat Body X 1PC</p>	<p>Loveseat Backrest X 2PCS</p>	<p>Single Frame X 2PCS</p>	<p>E1- Left Backrestx1 PC E2-Right Backrestx1PC</p>	<p>Ottoman Frame X 2PCS</p>	<p>Right Arm X 1PC</p>	<p>Single Back Cushion X 2PCS</p>
							
<p>Round Wood Leg X 20PCS</p>	<p>Pillow X 2PCS</p>	<p>Loveseat Back Cushion X 2PCS</p>	<p>Single Seat Cushion X 2PCS</p>	<p>Loveseat Seat Cushion X 2PCS</p>	<p>Ottoman Seat Cushion X 2PCS</p>	<p>Flat Washer Ø5/16" X 8PCS Bolt 5/16"X50mm X 8PCS</p>	<p>Allen key X 1PC</p>

STEP 1:

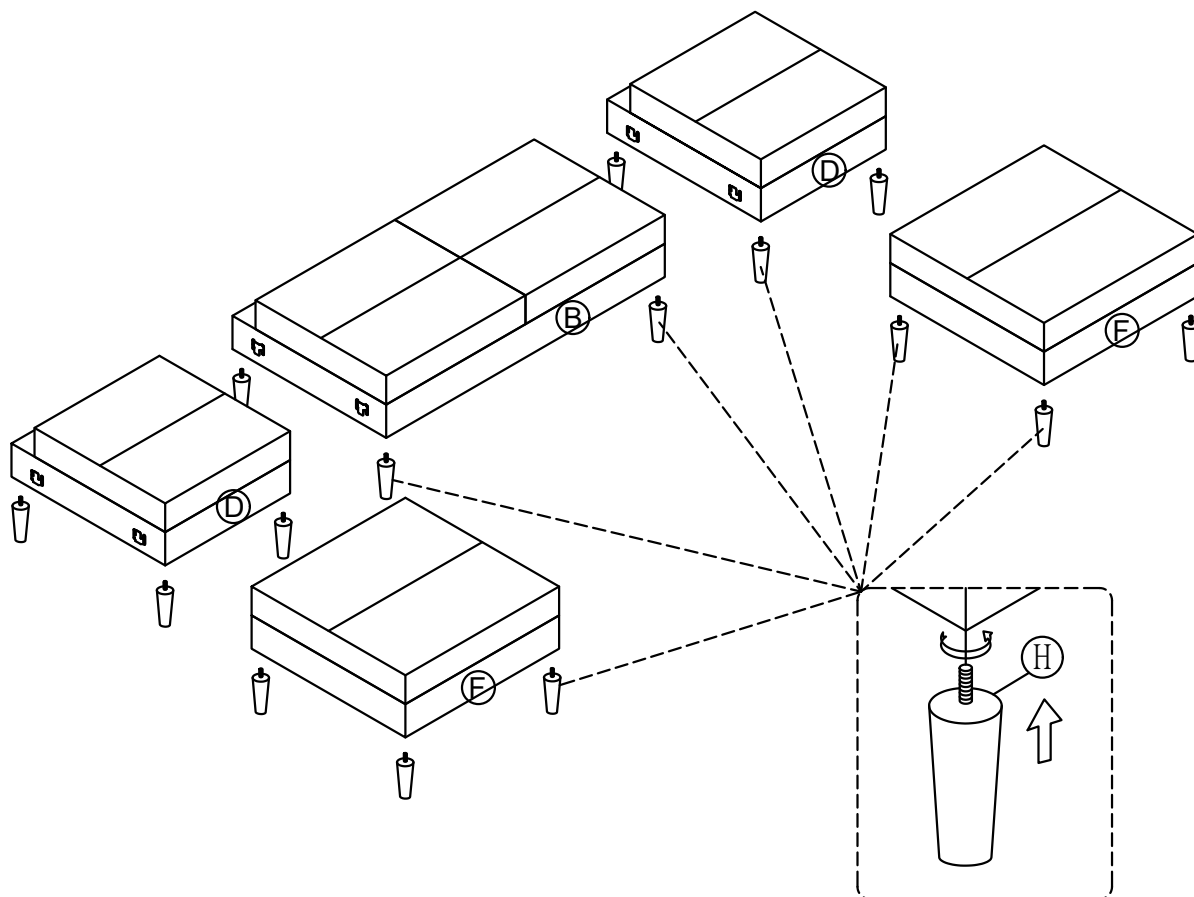

STEP 3:

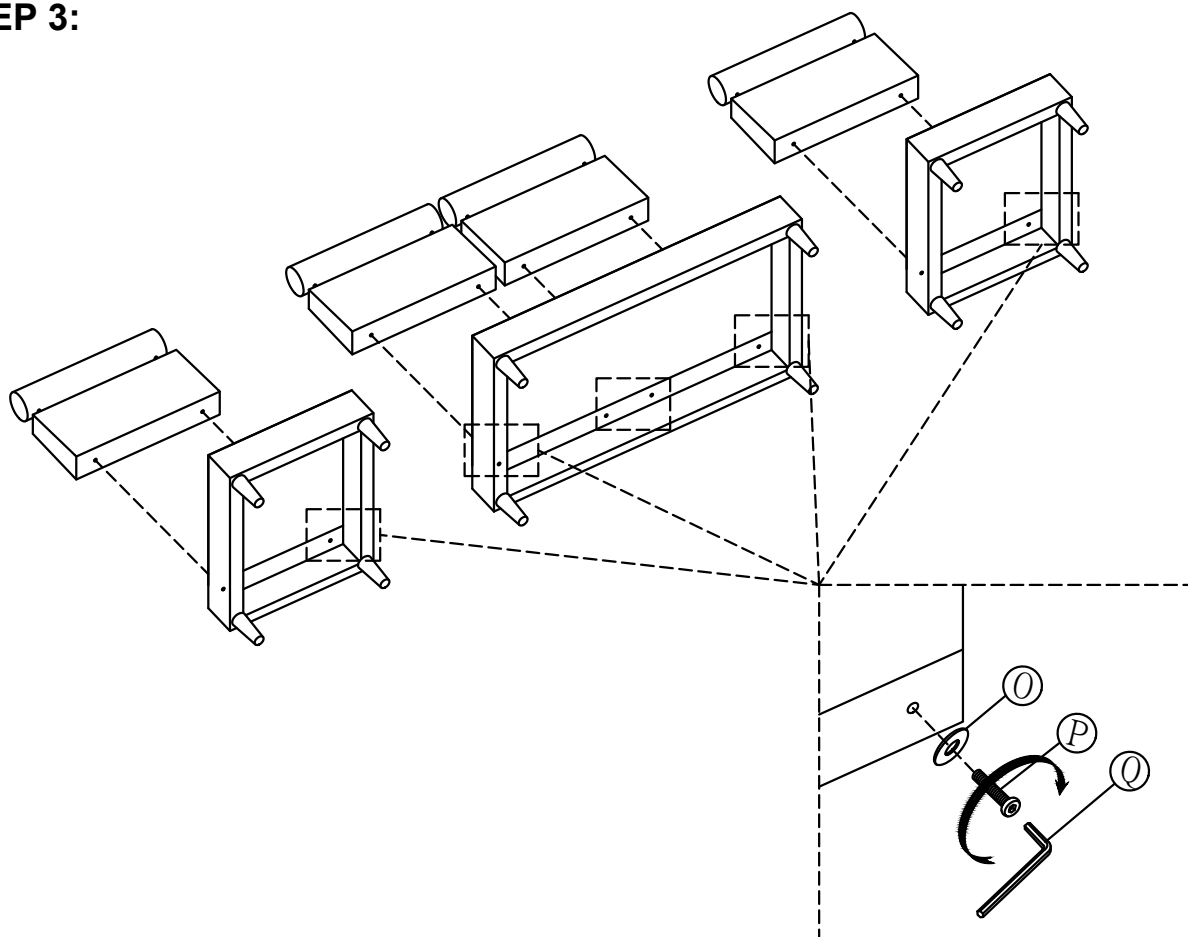

STEP 4:

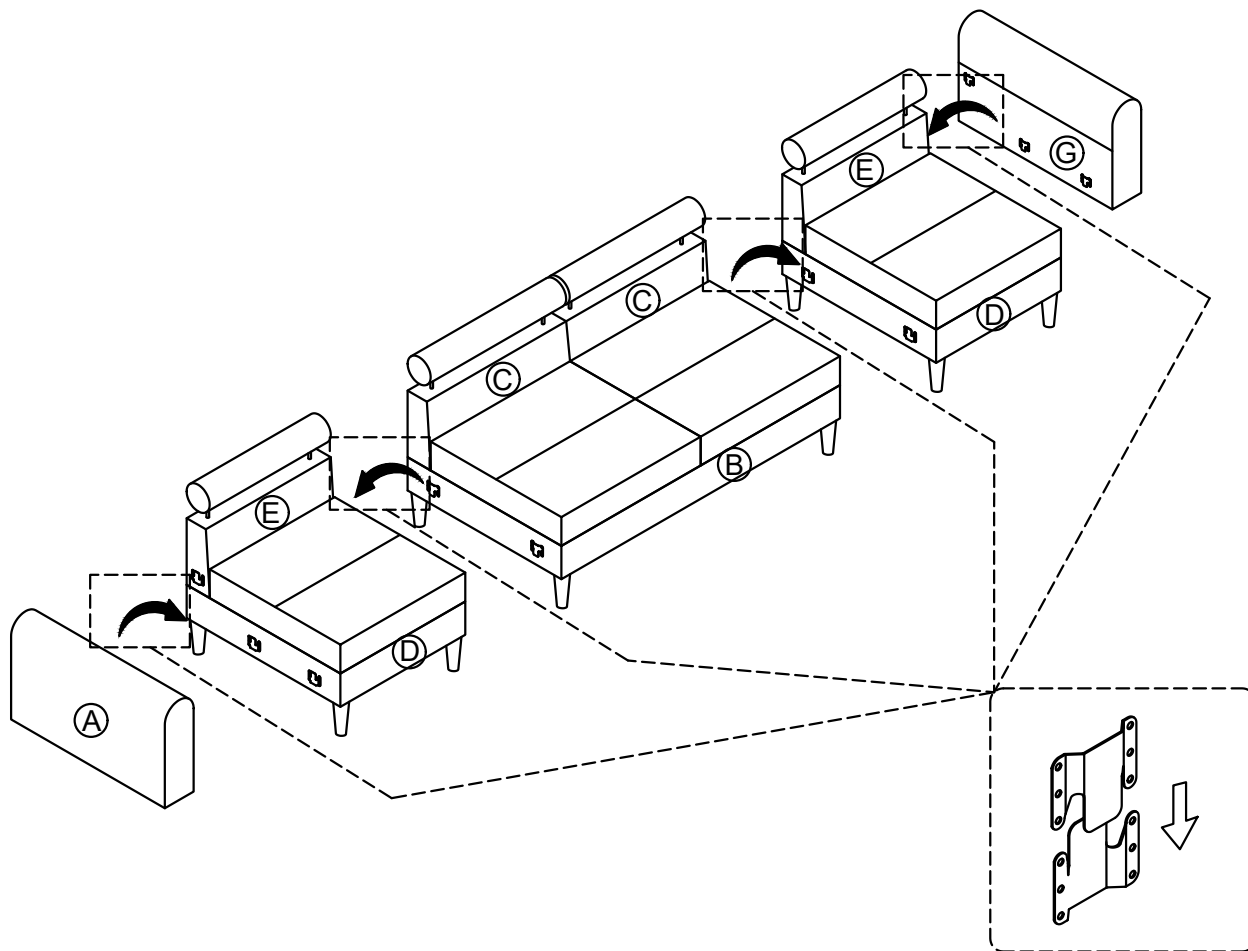

STEP 5:

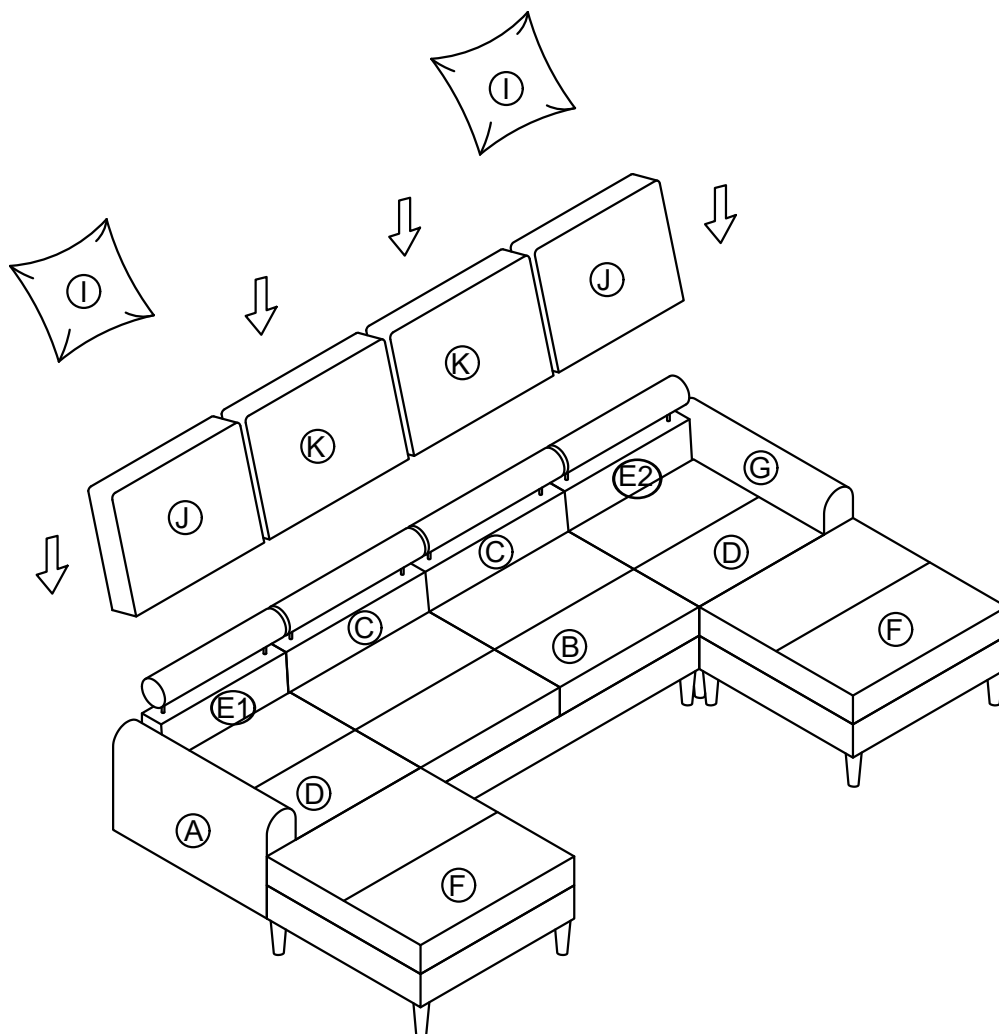

Helpful Hints

- Move your new furniture carefully, with two people lifting and carrying the unit to its new location.
- Your furniture can be disassembled and reassembled to move.
- Clean the product with a soft damp cloth. DO NOT use harsh chemicals or abrasive cleaners.

COMPLETED

