

NOTE: Finial shown is for illustration purpose only. It may not represent the style of finial purchased.

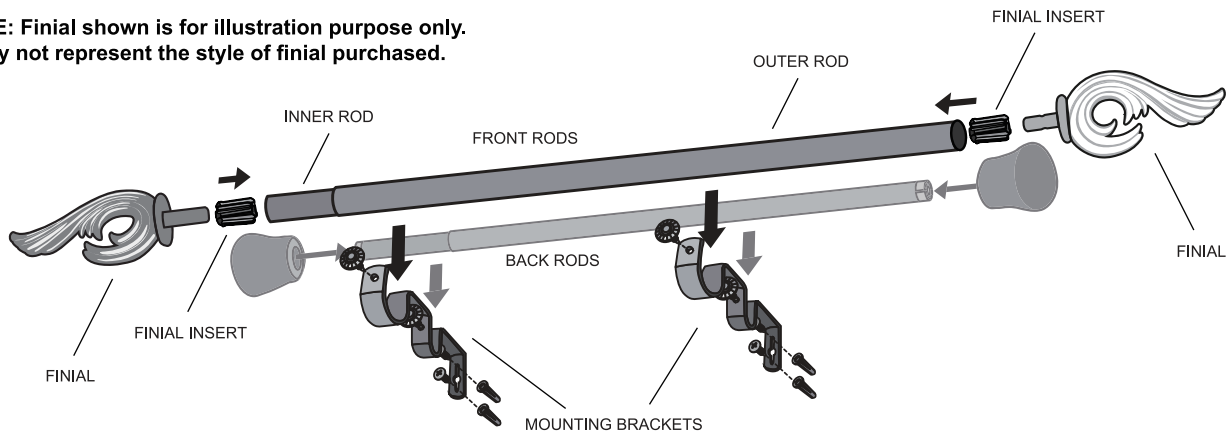

1 Place brackets against wall at desired locations. Mark screw holes with pencil. Be sure marks are level across opening. Mount at least one bracket on each inner rod and outer rod to prevent rod movement when sliding curtain.

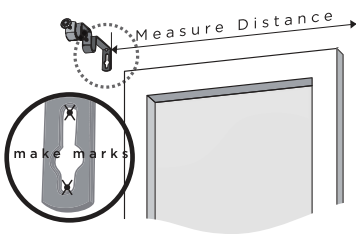

2 If screws are going directly into wood trim or wall studs, drill a 1/8" pilot hole at pencil marks. If screwing into drywall, follow drywall anchor instruction at the bottom of the page.

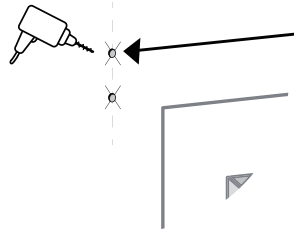

3 ASSEMBLE ROD
Assemble the rod by inserting and sliding the smaller diameter rod into the larger diameter rod. Ensure that finial inserts are exposed on each open end after rod assembly.

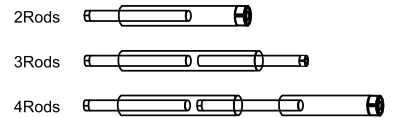

4 ATTACHING DRAPERY
Slide the drapery onto the pole.

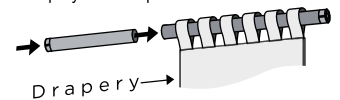

5 ATTACHING FINIALS
There are two diameters of white inserts included. For a three piece rod, there is only one diameter of white insert.

a. Skip this step if inserts are already attached to rod. Push corresponding insert into each end of rod with finial side going into the pole and flat end facing out.

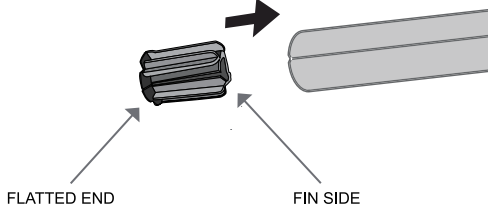

b. Attach finials by turning the end of the finial post into the end of the plastic insert until completely snug. Rotate finial on rod for proper alignment if required.

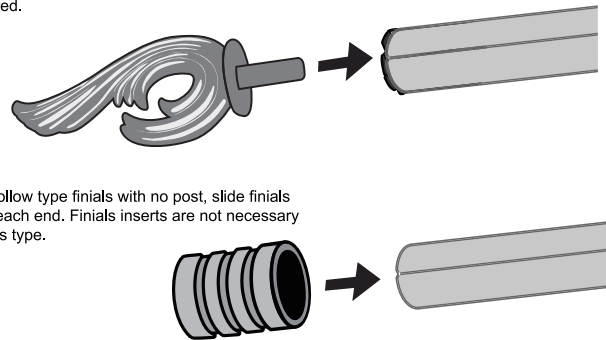

For hollow type finials with no post, slide finials onto each end. Finial inserts are not necessary for this type.

6 Extend rod to desired width. Lift rod with drapery and drop into brackets. Ensure to mount at least one bracket on each inner rod and outer rod to prevent rod movement when sliding curtain. Adjust draperies to desired position.

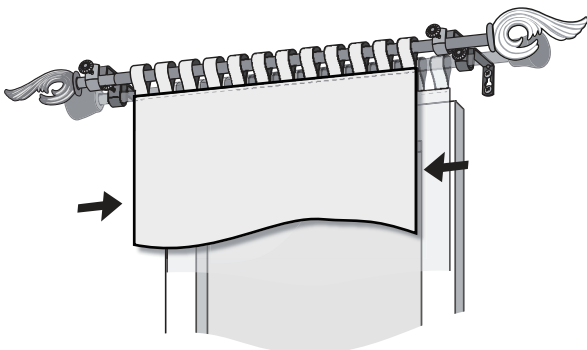

7 Lock rods into position by tightening leveling screw by hand until finger tight. This will prevent the rod from moving.

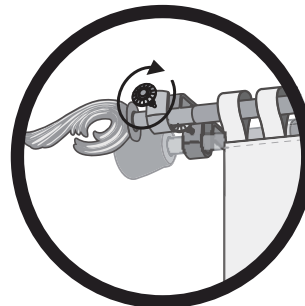

DRYWALL ANCHOR INSTALLATION



If screws are going directly into wood trim or wall studs - drill 1/8" (3mm) holes and install screws through bracket. If screws are going into hollow wall - drill 3/16" (5mm) holes and push or lightly hammer plastic anchors into holes. Then install screws through brackets. Do not tighten screws too much - just snug is best.