

ASSEMBLY INSTRUCTIONS

WF326034/ WF326035/ WF326036/ WF326037/ WF326038

PART LISTS BOX1: WF326034

A

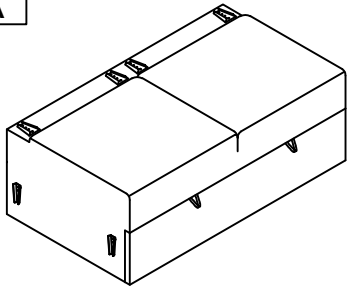

LOVESEAT (1 PC)

O



LOVE SEAT CUSHION
BACK (2 PCS)

K

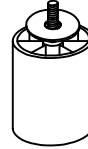

LEG (18 PCS)

L



WHEEL (8 PCS)

PART LISTS BOX 2: WF326035

B

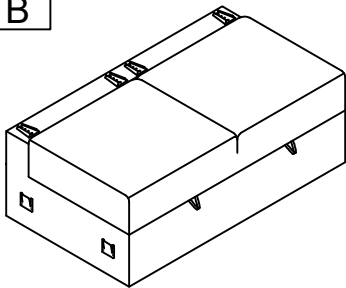

CHAISE (1 PC)

H

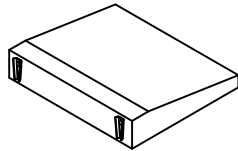

LOVE & CHAISE BACK
(4PCS)

J



CORNER CUSHION
BACK (1PC)

M



SCREW M4*30
(32 PCS)

PART LISTS BOX 3: WF326036

D

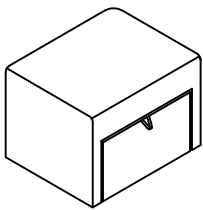

OTTOMAN (1 PC)

O

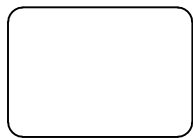

CHAISE SEAT
CUSHION BACK
(1PC)

C

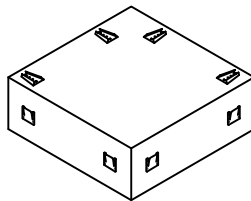

CORNER (1 PC)

I



CORNER CUSHION
BACK (1PC)

O



CHAISE SEAT
CUSHION BACK
(1PC)

PART LISTS BOX 5: WF326038

E

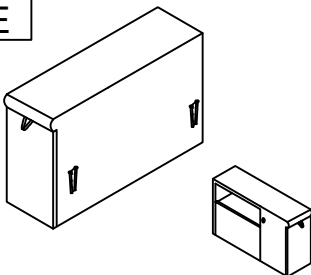

ARM (1 PC)

F

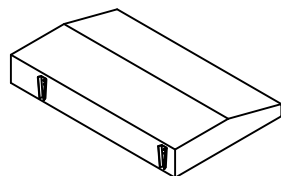

CORNER
BACK (1PC)

G

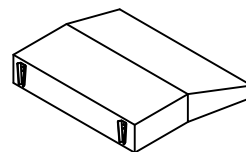

CORNER CHAIR
CUSHION BACK (1PC)

N

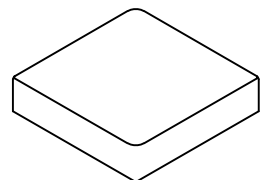

CORNER SEAT
CUSHION (1PC)

Step 1

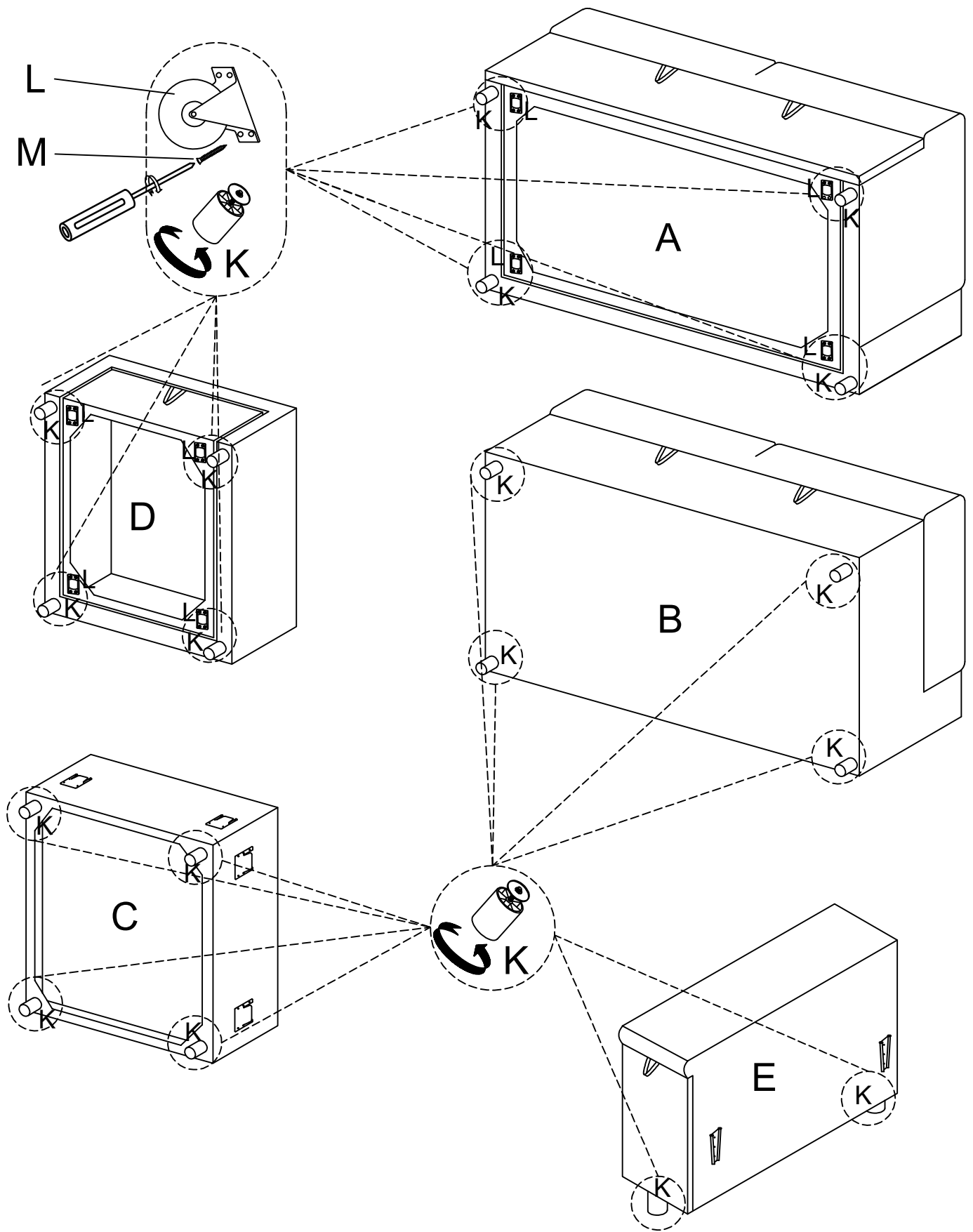

Step 3

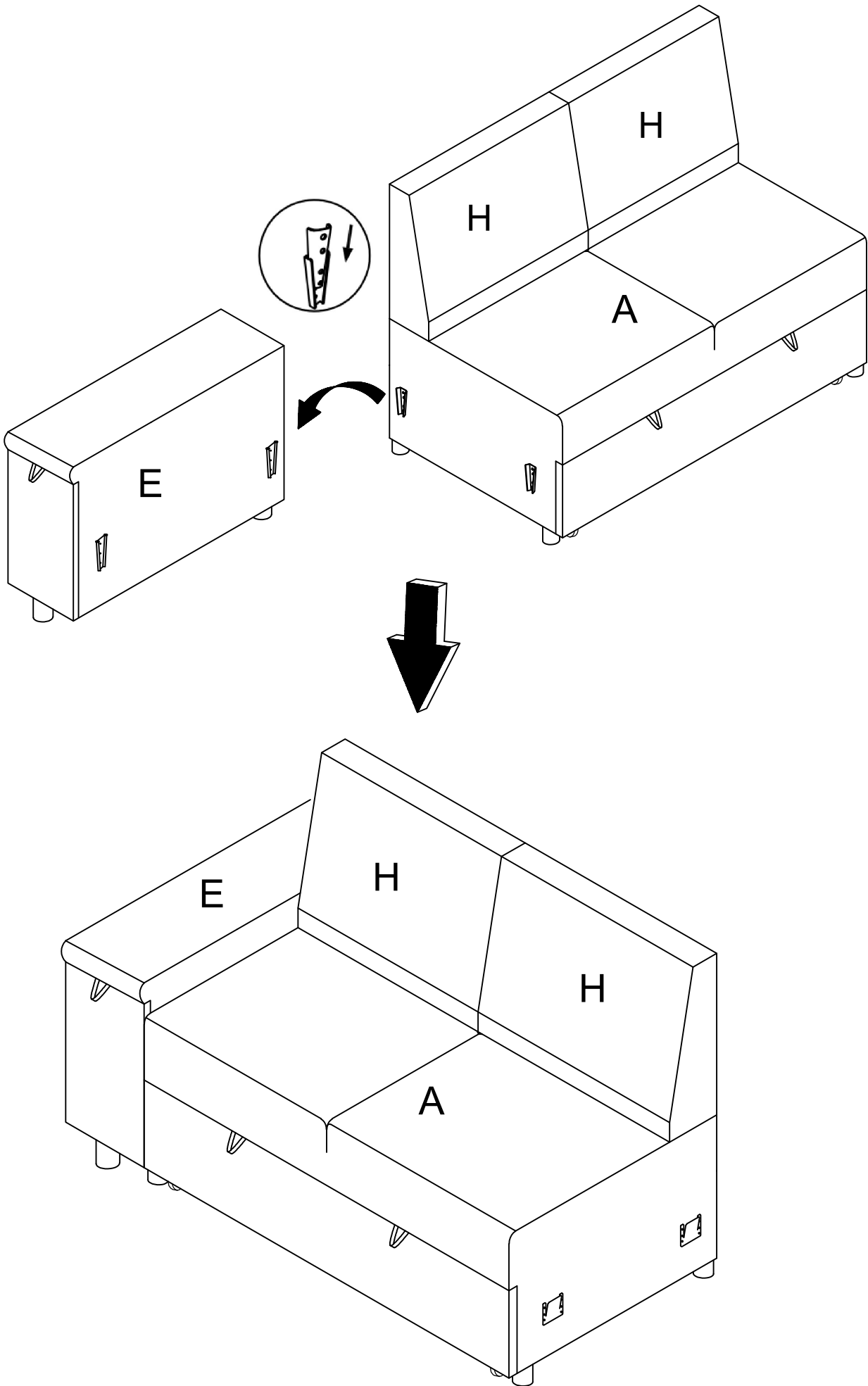

Step 4

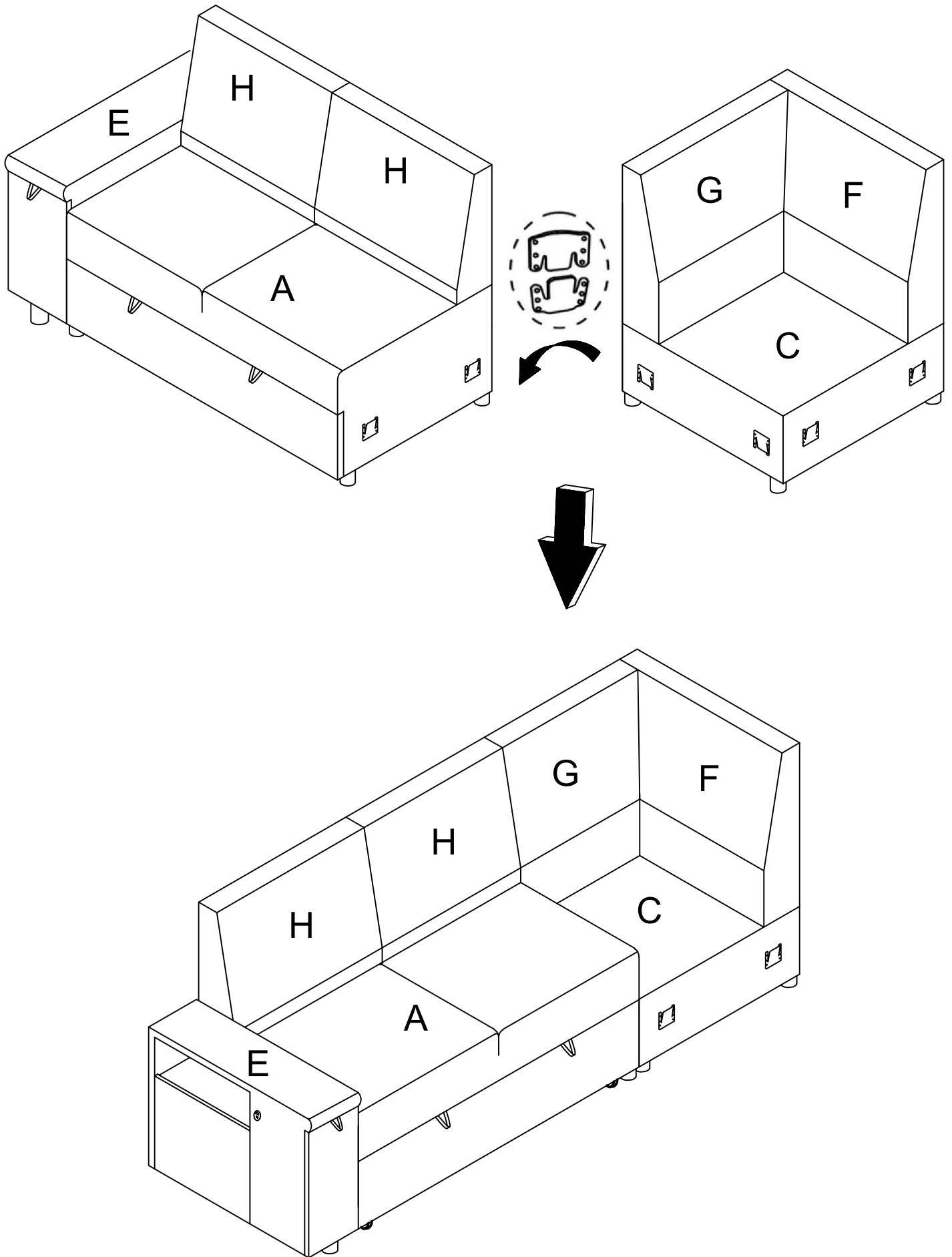

Step 5

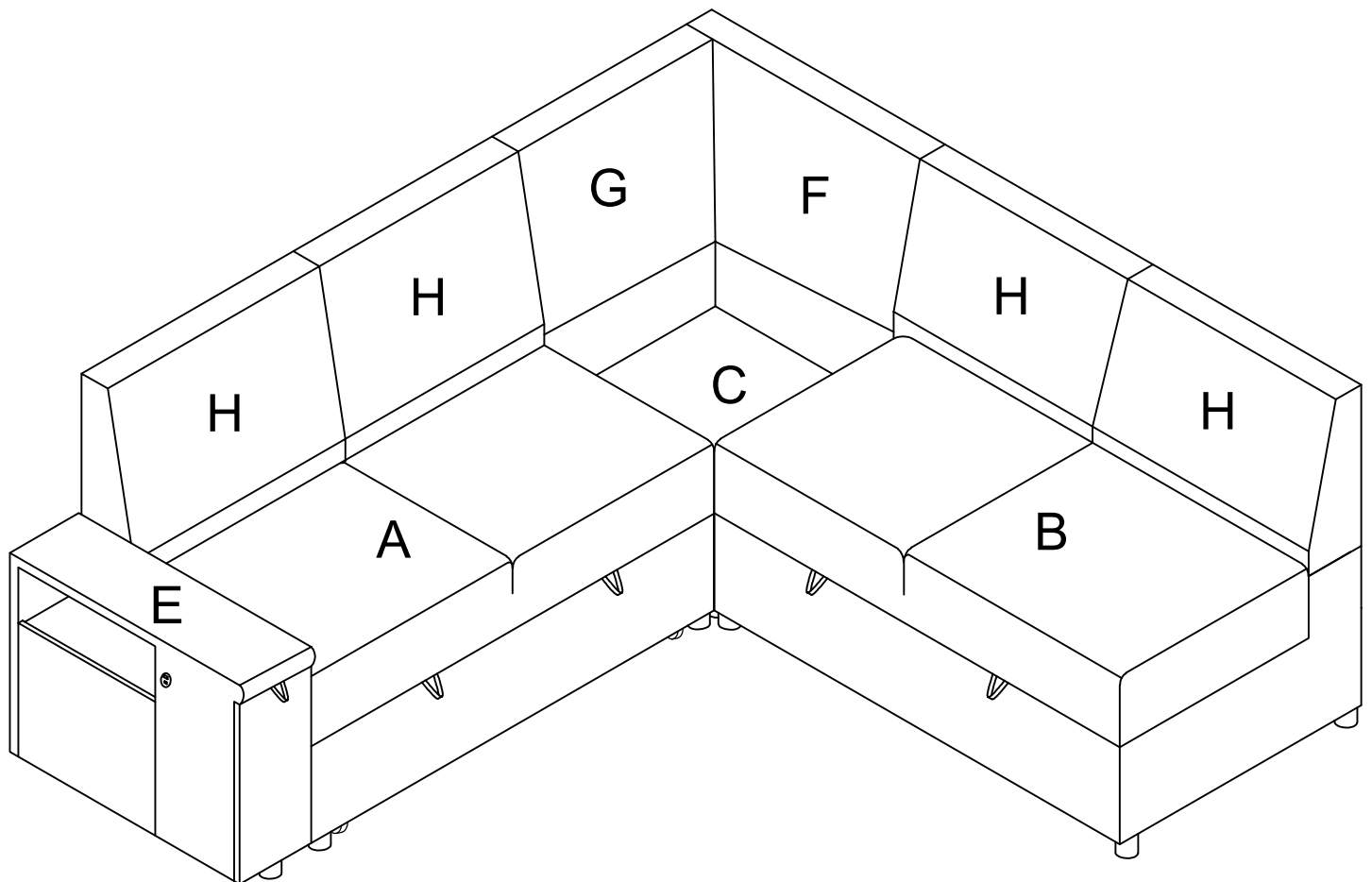
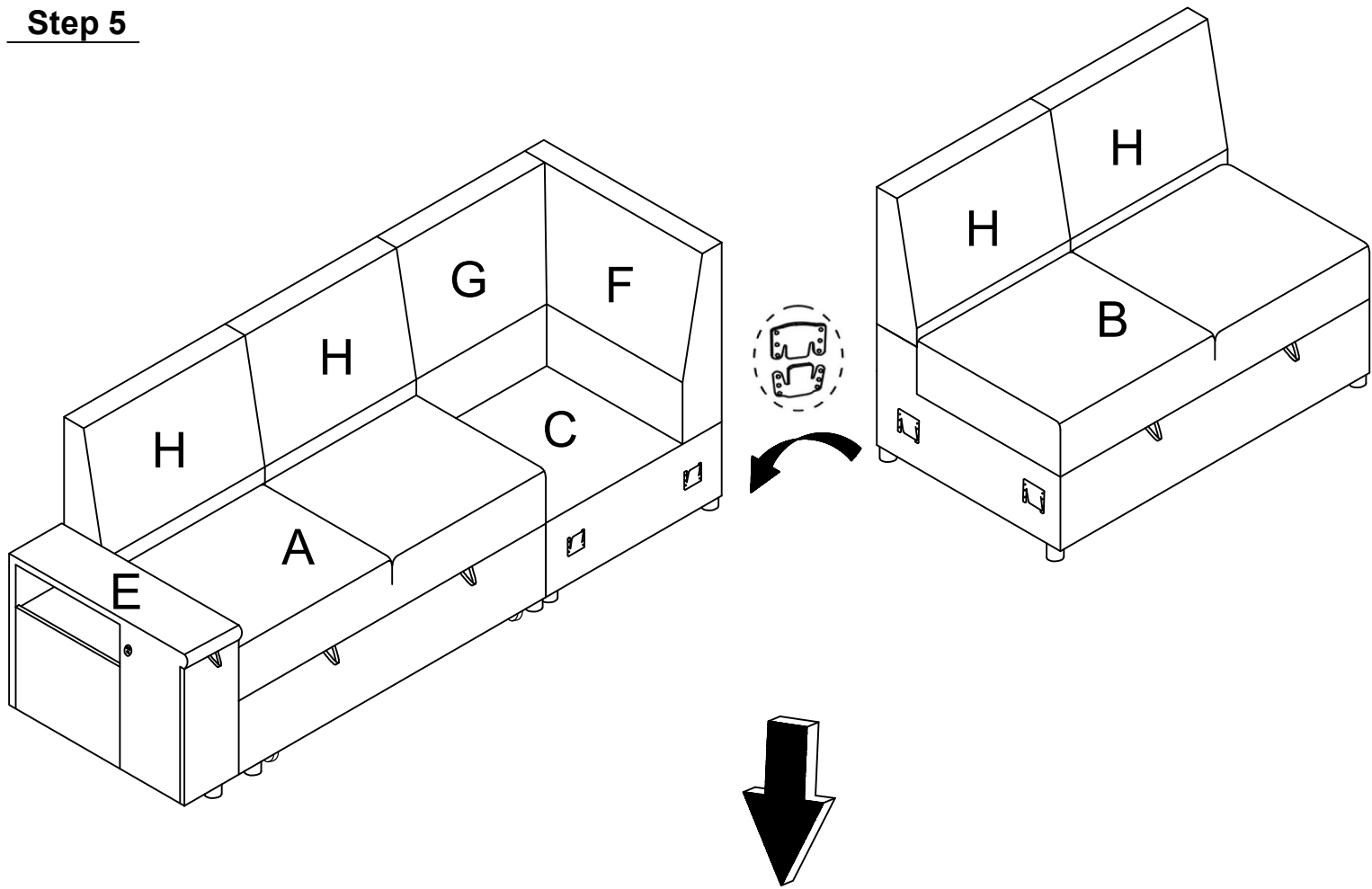

Step 6

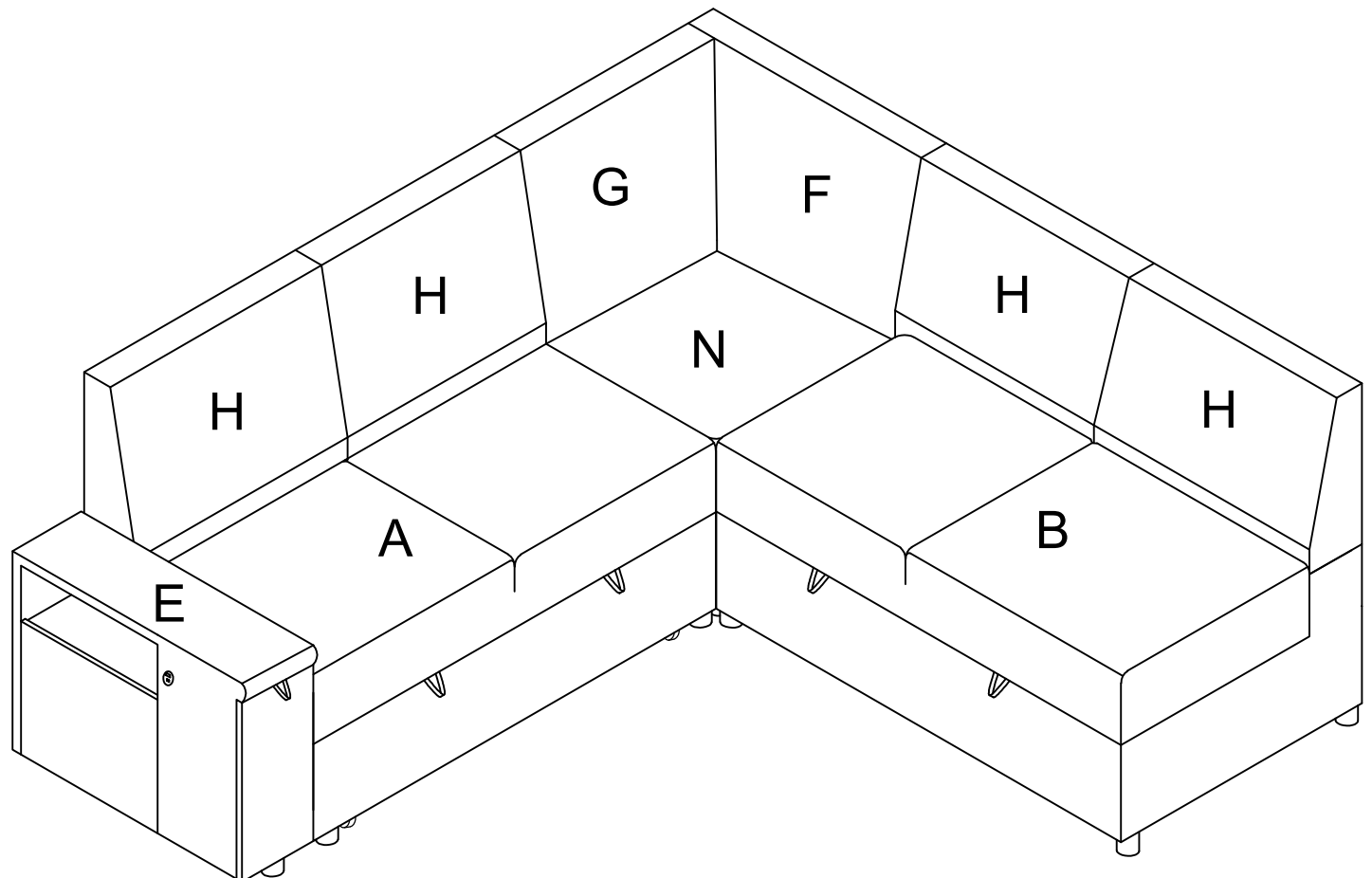
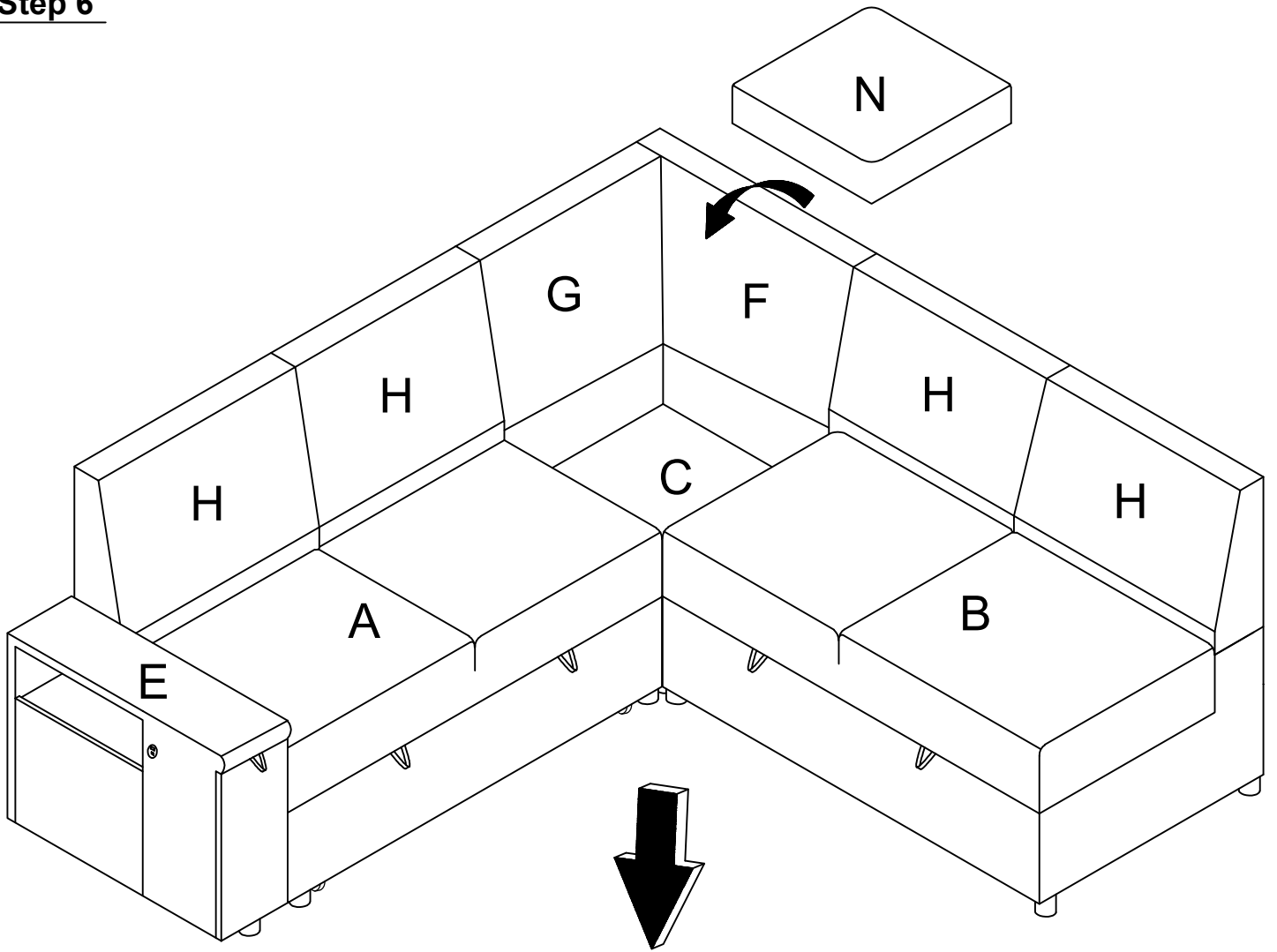

Step 7

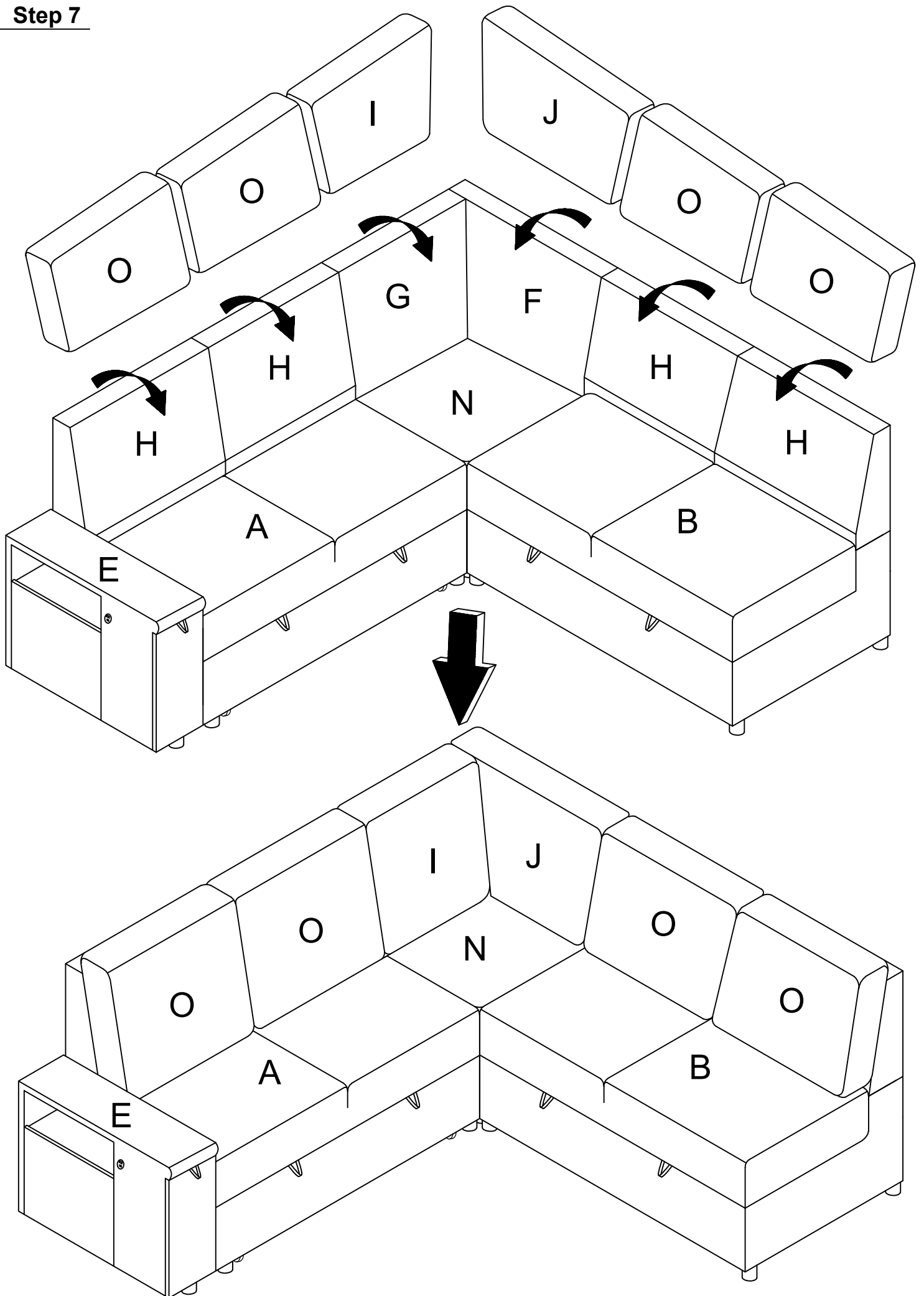

Step 8

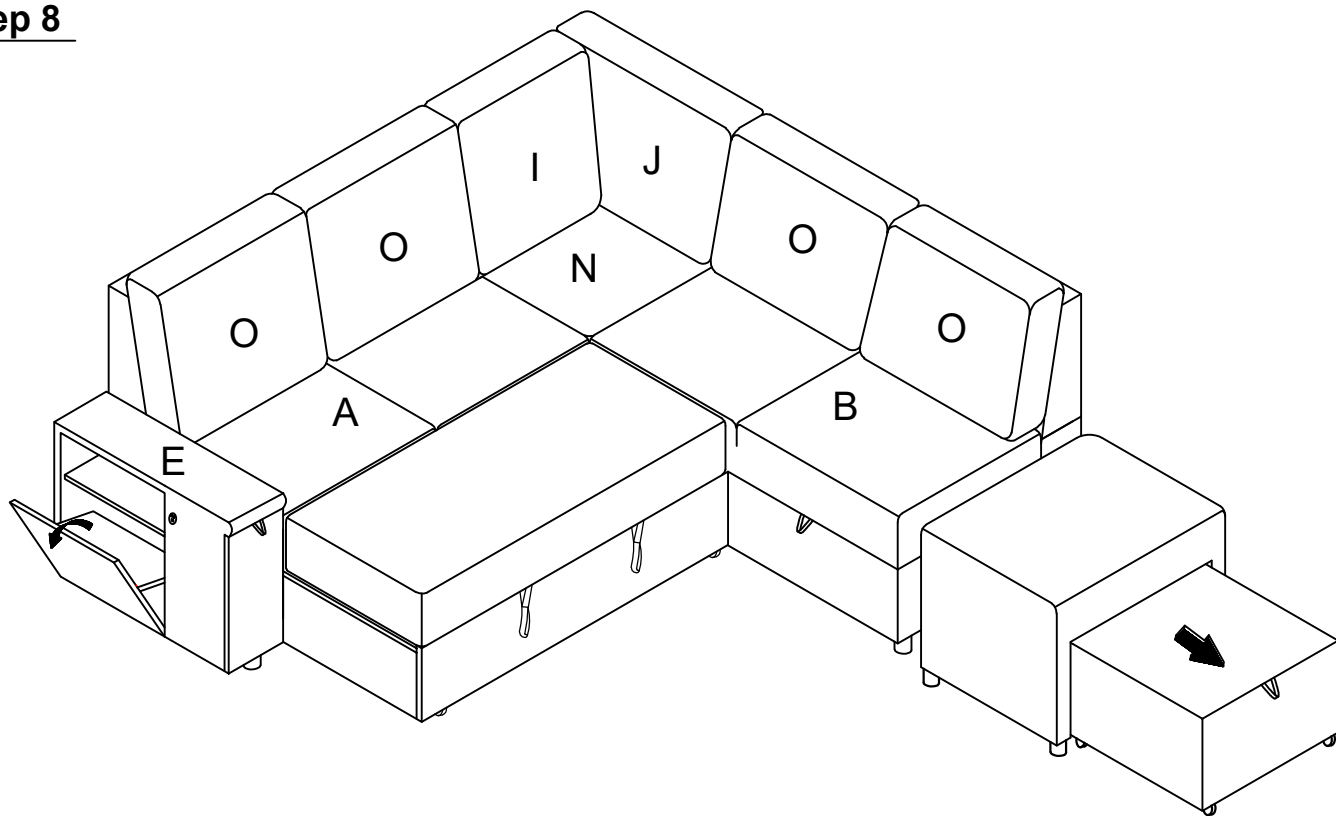

Step 9

