

ASSEMBLY INSTRUCTIONS



ACCENT CHAIR

ASSEMBLY INSTRUCTIONS

ASSEMBLY TIPS:

1. Remove hardware from box and sort by size.
2. Please check to see that all hardware and parts are present prior to start of assembly.
3. Please follow attached instructions in the same sequence as numbered to assure fast and easy assembly.



WARNING!

1. Don't attempt to repair or modify parts that are broken or defective. Please contact the store immediately.
2. This product is for home use only and not intended for commercial establishments.





ASSEMBLY TIME

8

MINUTES

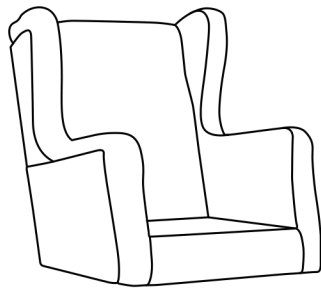
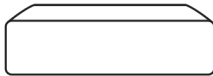
PARTS IDENTIFICATION

	PART NAME	FIGURE	QUANTITY
A	CHAIR BASE		1 PC
B	SEAT CUSHION		1 PC
C	FRONT LEG		2 PCS
D	BACK LEG		2 PCS

ASSEMBLY INSTRUCTIONS

STEP 1 *Install front and rear legs on underside of chair base.*

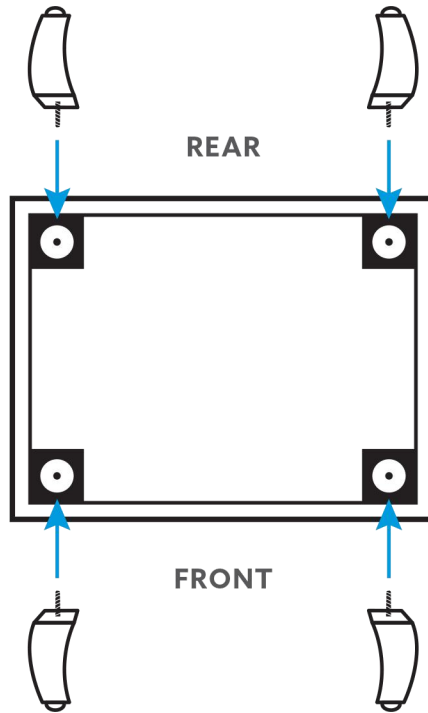

STEP 2 COMPLETE

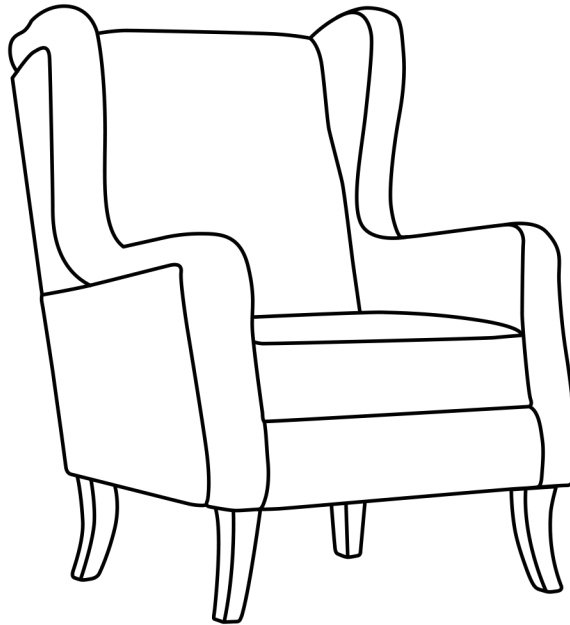

DIMENSIONS

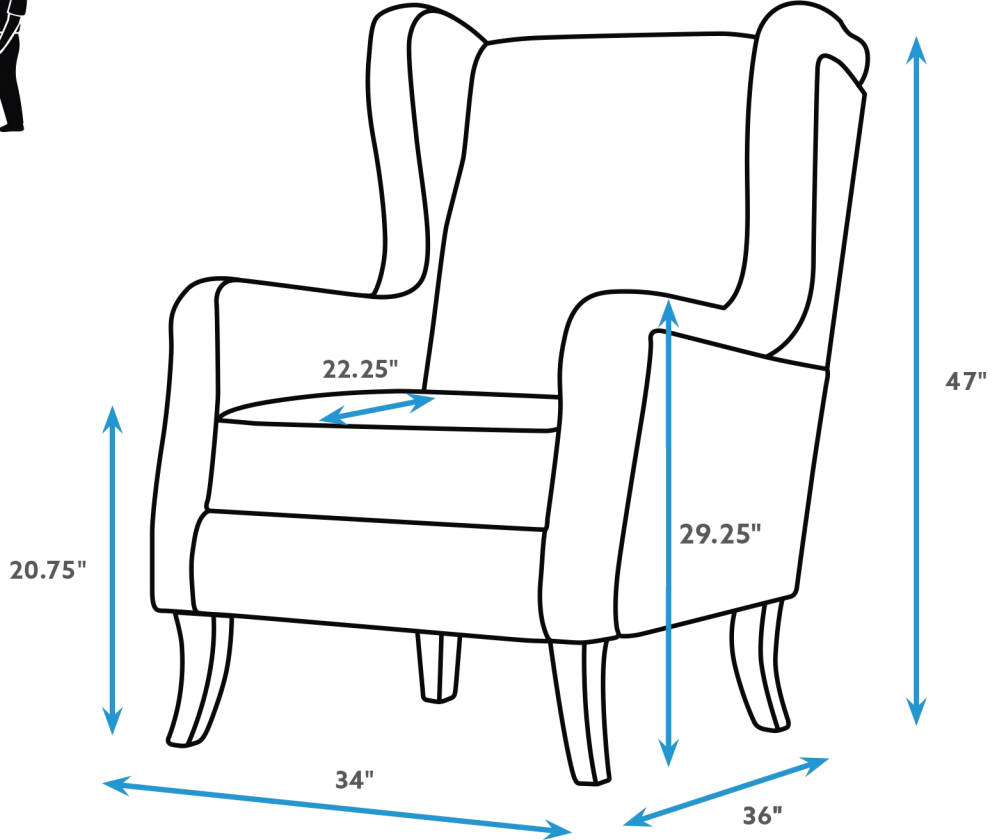

NOTE: Dimension tolerance $\pm 5\%$