

**BLACK+**  
**DECKER**

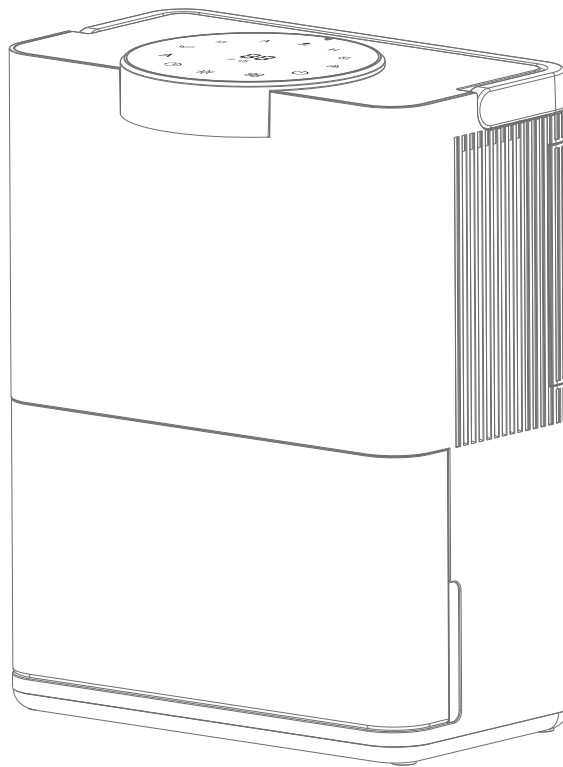

[www.blackanddecker.co.uk](http://www.blackanddecker.co.uk)

**BXEH60013GB**

**What's in the box**

- Instruction Manual
- Dehumidifier
- AC/DC Power Adaptor

**Features**

- 1. Display and light
- 2. Housing
- 3. Top cover
- 4. Handle
- 5. Air inlet
- 6. Power adaptor jack
- 7. Filter cover
- 8. Filter
- 9. Water tank cover
- 10. Water tank float
- 11. Water tank

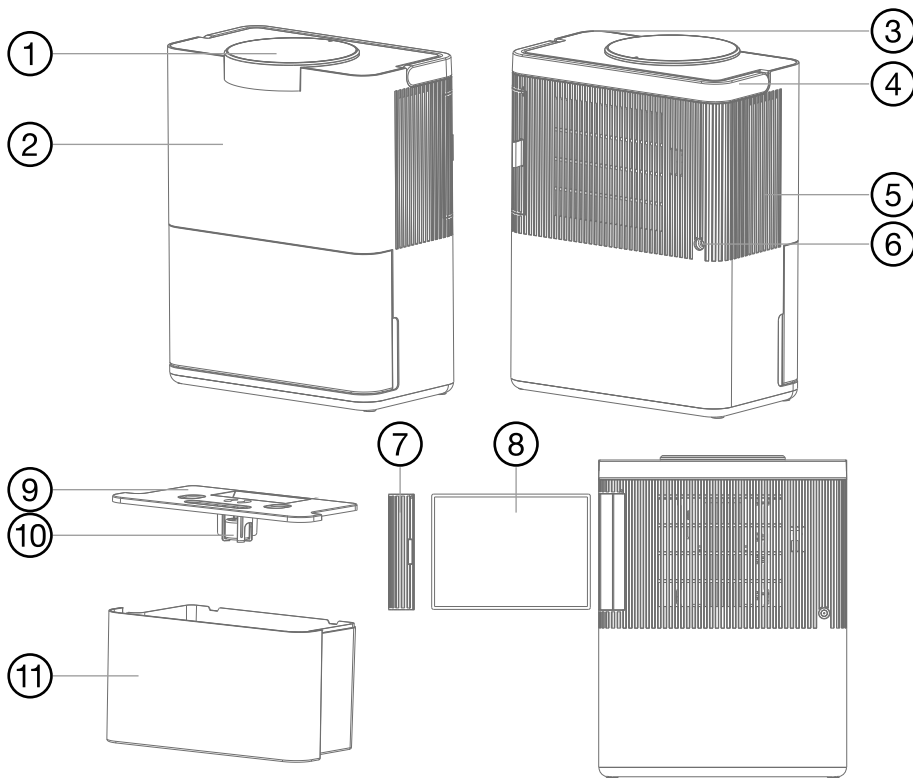

### Control Panel

- |                             |                                 |
|-----------------------------|---------------------------------|
| 1. Defrosting indicator     | 10. Air purifier mode indicator |
| 2. Timer indicator          | 11. Light On indicator          |
| 3. Sleep mode indicator     | 12. Automatic mode indicator    |
| 4. Strong mode indicator    | 13. LED display                 |
| 5. Power On/Off key         | 14. Wi-Fi indicator             |
| 6. Mode selection key       | 15. Humidity indicator          |
| 7. Light Mode selection key |                                 |
| 8. Timer key                |                                 |
| 9. Automatic mode key       |                                 |

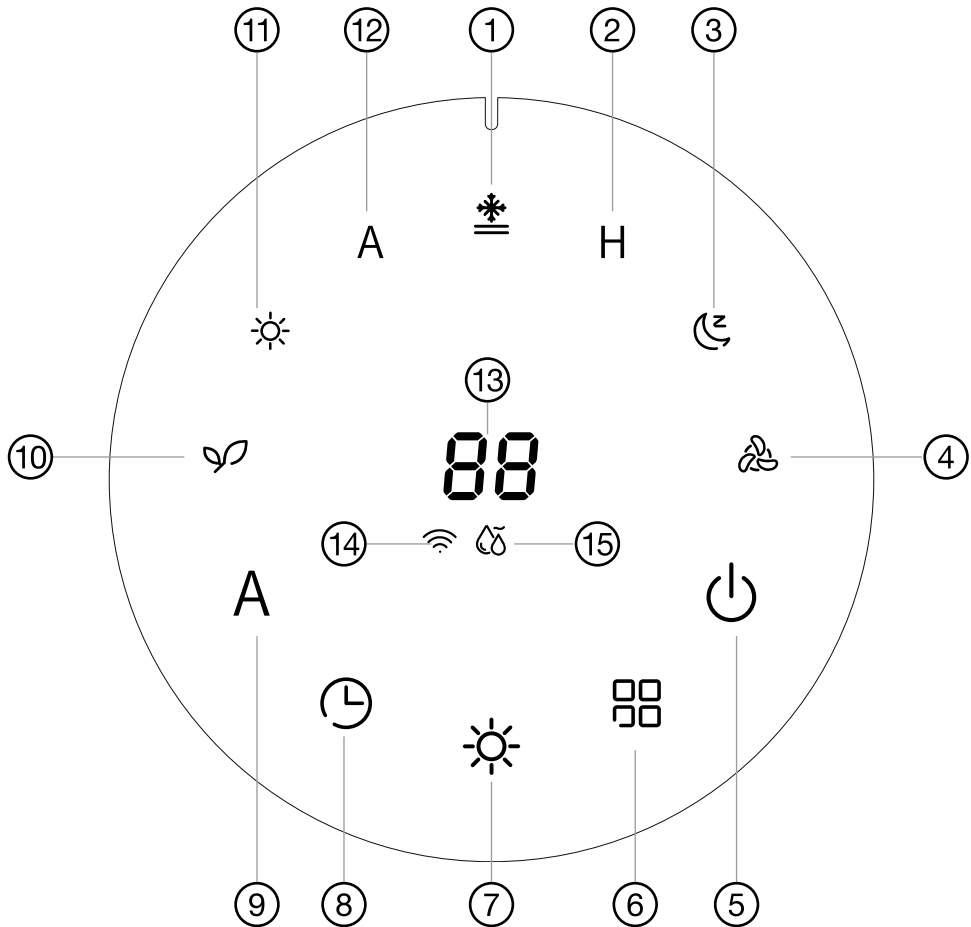

### Intended Use

Your BLACK+DECKER BXEH60013GB 3.2L 2-in-1 Smart Dehumidifier and Air Purifier has been designed for small and medium spaces.

This appliance is intended for indoor household use only.

Thank you for choosing BLACK+DECKER. We hope that you will enjoy using this product for many years.

### Safety Instructions

**▲WARNING:** Read all safety warnings and all instructions. Failure to follow the warnings and instructions listed below may result in electric shock, fire and/or serious injury.

- ◆ Read this manual carefully before using the appliance.
- ◆ The intended use is described in this manual.
- ◆ The unit is only to be used with the power supply unit provided with the appliance.
- ◆ The use of any accessory or attachment or the performance of any operation with this appliance other than those recommended in this instruction manual may present a risk of personal injury.
- ◆ Retain this manual for future reference.
- ◆ **▲WARNING:** When using mains-powered appliances, basic safety precautions, including the following, should always be followed to reduce the risk of fire, electric shock, personal injury and material damage.

### Using Your Appliance

Please read the operating instructions carefully before using your appliance for the first time.

- ◆ Check that the voltage of the main circuit corresponds with the rating of the appliance before operating.
- ◆ Children shall not play with the appliance.
- ◆ DO NOT let the cable hang over the edge of a table or counter or let it come into contact with any hot surfaces.
- ◆ The use of accessory attachments is not recommended by the appliance manufacturer, apart from those supplied with this product.
- ◆ DO NOT pull the plug out by the cable as this may damage the plug and/or the cable.
- ◆ DO NOT use this product for anything other than its intended use.
- ◆ This appliance is for household use only.
- ◆ DO NOT carry the appliance by the power cable.
- ◆ DO NOT use the appliance outdoors.
- ◆ DO NOT operate with wet hands.
- ◆ Use of an extension cable with this appliance is not recommended. However, if it is necessary to use an extension lead, ensure that the lead is suited to the power consumption of the appliance to avoid overheating of extension

cable, appliance or plug point. DO NOT place the extension cable in a position where it can be pulled on by children or animals or tripped over.

- ◆ Always unplug the unit when not in use or before cleaning.
- ◆ The manufacturer does not accept responsibility for any damage or injury caused by improper or incorrect use, or for repairs carried out by unauthorised personnel.

### Safety Of Others

- ◆ Close supervision is necessary when any appliance is used by or near children.
- ◆ Children should not play with the appliance.
- ◆ This appliance can be used by children aged from 8 years and above and persons with reduced physical, sensory or mental capabilities or lack of experience and knowledge if they have been given supervision or instruction concerning use of the appliance in a safe way and understand the hazards involved.
- ◆ Cleaning and user maintenance should not be undertaken by children without supervision.
- ◆ Take care when any appliance is used near pets.
- ◆ DO NOT allow the cord to become twisted.

### After Use

- ◆ While cleaning, DO NOT use a wet cloth or use water on any part of the unit, as this may cause a short circuit or electrical shock.
- ◆ Keep this unit clean. DO NOT allow objects to enter the ventilation opening as this may cause electric shock, or damage to the unit. Switch off the unit and then remove the plug from the socket when not in use or before cleaning.
- ◆ Check all inlets and outlets regularly for accumulated dust.
- ◆ Disconnect the unit from mains outlet when it is not in use, or before relocating or cleaning it.
- ◆ Switch off and remove the plug from the socket before leaving the appliance unattended and before changing, cleaning or inspecting any parts of the appliance.
- ◆ When not in use, the appliance should be stored in a dry place. Children should not have access to stored appliances.

### Inspections And Repairs

- ◆ DO NOT attempt to dismantle, repair or remould any part of the unit. This should only be done by a qualified service agent.

- ◆ In the unlikely event the appliance develops a fault, stop using it immediately and seek advice from the manufacturer.
- ◆ In case of technical problems, switch off the product and DO NOT attempt to repair it yourself. Return the appliance to an authorised BLACK + DECKER service facility for examination, adjustment or repair. Always insist on the use of original spare parts. Failure to comply with the above mentioned precautions and instructions, could affect the safe operation of this product. Further information about authorised BLACK + DECKER service facilities can be found on [www.2helpu.com](http://www.2helpu.com)
- ◆ DO NOT use the unit near open windows, as contact with rain and other natural elements could cause an electrical hazard
- ◆ DO NOT put heavy objects on the appliance.
- ◆ DO NOT tip the unit on its side.
- ◆ Never insert any other object into the unit body to avoid any hazard or unit failure.
- ◆ DO NOT put the unit close to heat-generating devices or near flammable and dangerous materials.
- ◆ The appliance must be positioned so that the plug is accessible.

**▲WARNING:** DO NOT place the unit near a gas or electric heat source.

### Additional safety instructions for Dehumidifiers

- ◆ Always operate the appliance on a smooth, even, stable surface. DO NOT place the unit on a hot surface.
- ◆ Ensure that the unit is switched off after use.
- ◆ DO NOT immerse cables, plugs or any part of the appliance in water or any other liquid.
- ◆ Operate the unit only at the voltage specified.

## Power Supply

Your adaptor has been designed for a specific voltage. Always check that the mains voltage corresponds to the voltage on the rating plate.

**▲ WARNING:** Never attempt to replace the adaptor unit with a regular mains plug.

- ◆ Do not expose the adaptor to water.
- ◆ Do not open the adaptor.
- ◆ Do not probe the adaptor.

## Electrical safety

### Symbols on the power supply



This appliance is double insulated; therefore no earth wire is required. Always check that the power supply corresponds to the voltage on the rating plate.



The power supply is intended for indoor use only.

## Labels on appliance

- ◆ The following symbols appear on this appliance along with the date code.



Read all of this manual carefully before using the appliance.

**▲ WARNING:** Before assembling, switch the appliance off and remove the plug from the socket.

## Features

1. Display and light
2. Housing
3. Top cover
4. Handle
5. Air inlet
6. Power adaptor jack
7. Filter cover
8. Filter
9. Water tank cover
10. Water tank float
11. Water tank

## Control Panel

1. Defrosting indicator
2. Timer indicator
3. Sleep mode indicator
4. Strong mode indicator
5. Power On/Off key
6. Mode selection key
7. Light Mode selection key
8. Timer key
9. Automatic mode key
10. Air purifier mode indicator
11. Light On indicator
12. Automatic mode indicator
13. LED display
14. Wi-Fi indicator
15. Humidity indicator

## Use

About the Controls

- ◆ On/Off button
- ◆ 3 operational modes: Strong, Sleep and Automatic
- ◆ 48-hour timer
- ◆ WiFi functionality
- ◆ Light function

## Before First Use

**Note:** Read all instructions and safety information carefully before first use. Please retain this information for future reference.

- ◆ Remove your appliance from the packaging.
- ◆ Check that there is no visible damage to the body.
- ◆ Dispose of the packaging in a responsible manner.
- ◆ Remove any stickers or labels from the appliance. DO NOT remove the rating label.
- ◆ Wipe the outside of the appliance with a damp cloth.
- ◆ Situate your appliance according to the Safety Instructions section.

## Turning the Unit ON or OFF

**▲CAUTION:** Ensure that the water tank is firmly secured in position before turning the appliance on.

- ◆ To use the appliance, begin by plugging the adaptor into the corresponding jack at the back of the unit, and the plug into a compatible mains socket, ensuring the socket switch is in the ON position. There will be a sound prompt and the Power On/Off key will illuminate.
- ◆ Once the unit is plugged in, press the Power On/Off key to turn the unit on. The control panel will illuminate and the unit's LED display will show the unit is in Strong mode.
- ◆ Press the Power On/Off key again while the unit is in operation to turn it off. The control panel will go out and the unit will stop operating after a few seconds. Alternatively, pull the adaptor out of its jack at the back of the unit to cut off power to the dehumidifier.

## Mode Selection

- ◆ This unit is equipped with a choice of three operational modes: Strong, Automatic and Sleep.
  - In Strong mode, the unit will automatically operate in the high fan setting for strong dehumidification
  - In Sleep mode, the unit will operate at a low fan setting, the water tank light will be turned off and the control panel display will be dimmed.
  - In Automatic mode, humidity levels can be set, for automatic continuous dehumidification.

- ◆ Press the Mode selection key to cycle between the Strong and Sleep modes. The corresponding indicator will light up on the unit's control panel.
- ◆ Alternatively, press the Automatic mode key to select Automatic mode. The corresponding indicator will light up on the unit's control panel.

## Setting the Humidity

Humidity levels for the unit can be set to between 40 and 70 percent when operating on Automatic mode. The unit will then automatically dehumidify to the selected level.

- ◆ Press the Automatic mode key to cycle through and select the desired humidity level for the unit. The currently selected humidity level will flash for 2 seconds, then the display will revert back to showing the current room humidity.

## Setting the Timer

This unit is equipped with a timer, allowing for up to 48 hours of continuous operation.

- ◆ Touch the Timer key once to activate the Timer selection mode. The 'H' indicator will light up on the unit's control panel.
- ◆ When the Timer function is active, repeatedly touch the Timer key on the unit's control panel to cycle through and select the available timers, as follows: 0h-2h-4h-8h-12h-18h-24h-36h-48h-OFF.
- ◆ Once a timer option is selected, the unit will automatically operate for the selected period of time, then turn itself off when it elapses.

## Turning the LED Effect On and Off

This unit is equipped with a manually adjustable LED effect.

- ◆ The top light and the multi-coloured LED effect will automatically light up when the unit is turned on.
- ◆ Press the Light mode selection key once to turn the top light off. The LED effect will remain lit.
- ◆ Press this key a second time to turn the LED effect off and the top light back on.
- ◆ Press this key a third time to turn both lights off.

**Note:** Pressing the Mode key at any time to select Sleep mode will turn the light effects off. Pressing this key again will reset the light effects back to the default setting.

**Note:** The LED effect automatically cycles through the available colours. This effect cannot be paused or changed, and the LED colours cannot be manually selected.

### Connecting to WiFi/Downloading The App

- ◆ To start using the 'BLACK+DECKER Home' app, begin by downloading it from the Apple App store or the Google Play store. Scan the QR Codes shown below to download the app directly from either store.
- ◆ Follow the instructions in the app to create an account and connect the dehumidifier to a WiFi network.

**Note:** Other app and device instructions are also available in the app.



### Connecting the App to the Unit

- ◆ Install the "BLACK+DECKER Home" app and create a user account, as detailed above.
- ◆ Plug the appliance in and press and hold the Mode button for 3 seconds. The WiFi indicator will illuminate and begin to flash to show the unit is pairing.
- ◆ Place the appliance within 5 metres of your router.
- ◆ As long as the power is turned on and the mode button has been pressed and held for 3 seconds, the WiFi indicator flashes. If there is no network configuration after 3 minutes, the status will be cancelled and the indicator light will go out. If you need to re-connect to WiFi, long press the Timer key for 5 seconds to start the network configuration. The WiFi indicator will flash again.

### WiFi Connection

The unit can be connected to WiFi in two different ways.

#### Method 1/Bluetooth Connection

- ◆ Activate the Bluetooth function in the corresponding smart device.
- ◆ When the WiFi indicator flashes, open the 'BLACK+DECKER Home' app. The unit will automatically connect to the device via Bluetooth.

#### Method 2

- ◆ When the WiFi indicator flashes, select 'Add Device-' Home Appliances-'Dehumidifer', and follow the instructions on the display.
- ◆ Check the status of the WiFi indicator and choose the correct status.
- ◆ If the WiFi indicator flashes rapidly, the unit can be connected to Bluetooth directly.
- ◆ If the WiFi indicator flashes slowly, press "Connect" to connect to the WiFi network named 'BLACK+DECKER Home'.

### Configuring Different SSD Bands for 2.4GHz and 5GHz

- ◆ If your router supports both the 2.4 GHz and 5 GHz bands, but only one Wi-Fi name is displayed on the Wi-Fi search page of your mobile phone, perform these steps:
  1. Go to the Wireless page of the router. (The entry address is usually provided on the label attached to the back of the router).
  2. Go to the 2.4 GHz setting page, and set the Wi-Fi name (SSID) to XXX—2.4G, where xxx indicates the Wi-Fi name. Save setting.
  3. Go to the 5 GHz setting page, and set the Wi-Fi name (SSID) to XXX—5G, where xxx indicates the Wi-Fi name. Save setting.
- ◆ When the preceding settings are complete, the new Wi-Fi names will appear on the Wi-Fi settings page of your mobile phone.

**Note:** After the Wi-Fi names are changed, you need to reconnect the devices that use this wireless router. The password remains the same if it has not been changed.

### Using the App

Once the app is downloaded, carry out the following steps to control the unit remotely through the corresponding smart device.

- ◆ Tap the Power On/Off key on the app's main screen to turn the unit On or Off.

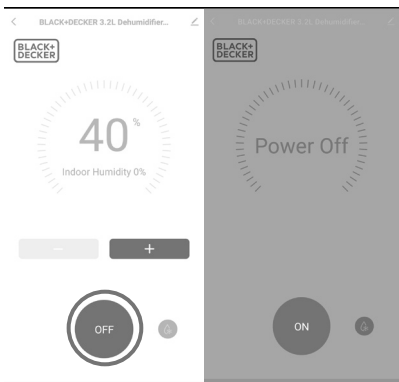

Power ON Screen    Power OFF Screen

- ◆ Tap the + and – keys on the app's main screen to increase or decrease the humidity levels. The current humidity level is displayed above the two keys.



- ◆ Tap the Timer key on the app's main screen to access the timer screen. In the new screen, click Add Timer to program and set a timer.

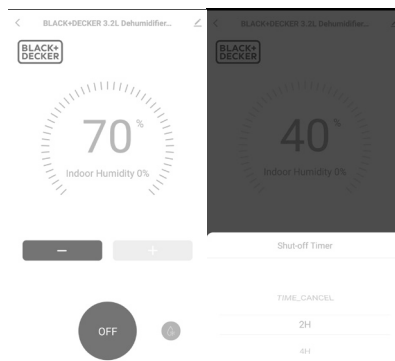

- ◆ Tap the Mode key on the app's main screen to switch between operational modes (Sleep and Strong).

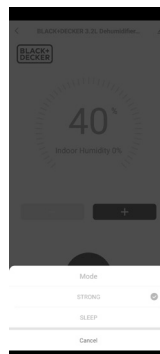

## Cleaning and maintenance

**⚠WARNING:** DO NOT IMMERSE THE UNIT, POWER CORD OR PLUG IN WATER OR ANY OTHER LIQUID.

**⚠WARNING:** Before cleaning and maintenance, switch the appliance off, unplug the adaptor from the appliance and remove the adaptor from the mains socket, to prevent electric shock.

- ◆ DO NOT immerse any part of the appliance, power cord or plug in liquids.
- ◆ Use a soft damp cloth to wipe the outer casing. Avoid using detergent, spray or chemicals as these may cause damage to the appliance.
- ◆ Use a dry cloth to wipe the control panel. DO NOT use water on the control panel.
- ◆ Clean the water tank with a soft cloth. DO NOT use an abrasive brush, as this might scratch the surface.
- ◆ Dry the water from inside the float. DO NOT take the float assembly apart.
- ◆ Once the tank has been cleaned, allow it to dry thoroughly before refitting it into the unit.

**Note:** DO NOT repair or disassemble the unit. In the unlikely event of the appliance developing a fault seek advice from the manufacturer.

## Removing and Cleaning the Water Tank

This unit is equipped with a removable water tank, for ease of cleaning.

- ◆ To clean the water tank, pull it out of the appliance, as shown in the figure below.
- ◆ Once the water tank is detached from the unit, pull the top out of the tank, as shown in the figure below.
- ◆ Empty the water tank and clean it with a soft, damp cloth and some mild detergent. Leave to dry thoroughly.
- ◆ Once the water tank is fully dry, place the lid back onto it and place it back into the unit.

**Note:** Ensure the water tank is firmly secured before attempting to use the unit, as the dehumidifier will not work otherwise.

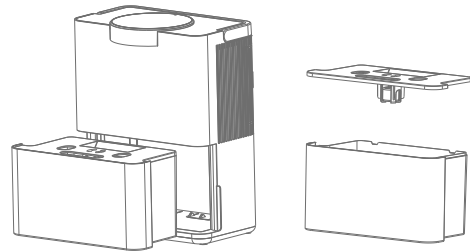

## Removing and Replacing the Filter

This unit is equipped with a replaceable HEPA filter.

- ◆ To replace the filter, open the filter cover, as shown in the figure below, and pull out the HEPA filter.
- ◆ Replace the HEPA filter, then place it back into the filter compartment and replace the filter cover, as shown in the figure below.
- ◆ The unit is now ready for normal use.

**Note:** It is recommended that the HEPA filter be replaced approximately every six months. Replacement HEPA filters can be purchased online via SKU BXEH60013GB01 on Amazon or at [www.rkw ltd.com](http://www.rkw ltd.com)

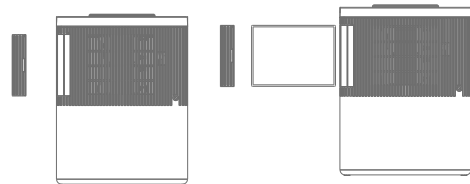

## To store your appliance:

- ◆ Ensure that the dehumidifier is cool, clean and dry before you store it.
- ◆ Store the appliance in a cool and dry place, out of the reach of children.

## Protecting the environment



Separate collection. Products and batteries marked with this symbol must not be disposed of with normal household waste.

Remember the environment when disposing of packaging around the appliance and when the appliance is no longer required.

Products and batteries contain materials that can be recovered or recycled, reducing demand for raw materials. Please recycle electrical products and batteries according to local provisions. Further information is available at [www.2helpU.com](http://www.2helpU.com).

## Technical data

		BXEH600113GB
Input voltage	V AC	18
Frequency	Hz	50/60Hz
Power input	W	47
Water Tank Capacity	L	3.2
Weight	KG	2.93
Dimensions	CM	H 25.8 x W 15.8 x D 33.4cm

## Product Guarantee

This product comes with a 2 Year guarantee from the original date of purchase. If any defect arises due to faulty materials of workmanship, the faulty products must be returned to the place of purchase. Refund or replacement is at the discretion of the retailer. This guarantee is in addition to and in no way prejudices your statutory rights.

### The Following Conditions Apply:

- ◆ The product must be returned to the retailer with proof of purchase or a receipt within the 1st year of purchase. For any product related issues after 12 months please contact our customer services team.
- ◆ The product must be installed and used in accordance with the instructions contained in this instruction guide.
- ◆ It must be used only for domestic purposes.
- ◆ It does not cover wear and tear, damage, misuse or consumable parts.
- ◆ This guarantee is valid in the UK and Republic of Ireland.

## Product Security and Telecommunications Infrastructure (PSTI)

Your Black+Decker 3.2L 2-in-1 Smart Dehumidifier and Air Purifier is an interconnected product which uses both wifi and Bluetooth to connect to the BLACK+DECKER Home App. As more devices in the home become connected to the internet, cyber security of the Internet of Things (IoT) is increasingly important to protect end users.

The Black+Decker 3.2L 2-in-1 Smart Dehumidifier and Air Purifier will deliver an updated experience on a regular basis including security patches. It is strongly recommended for best performance and security that all maintenance updates should be accepted as soon as possible. The 3.2L 2-in-1 Smart Dehumidifier and Air Purifier will continue to update until the specified date found within the Software Update website address. Please note updates may well continue after the date but it is likely that they will be less frequent. For further information please visit the below links.

For Security Reporting, Black+Decker actively tries to identify and reduce potential vulnerabilities during the products lifetime and in this effort we value input on actual or potential vulnerabilities reported by yourself.

If you believe you have discovered a vulnerability in a Black+Decker product please follow the Security Report website address below and follow the steps to complete the Security Reporting Form. Further information regarding the process is referenced on our website.

### **Security Reporting Website Address:**

[www.rkwltd.com/#!/security-reporting](http://www.rkwltd.com/#!/security-reporting)

### **Software Updates Website Address:**

[www.rkwltd.com/#!/software-updates](http://www.rkwltd.com/#!/software-updates)

### **For all customer service enquires please contact us below;**

RKW,  
Sutton House,  
Berry Hill Road,  
Stoke-on-Trent,  
ST4 2NL  
Email [blackanddecker@rkwltd.com](mailto:blackanddecker@rkwltd.com)  
Tel 0333 220 6089

Black & Decker® and BLACK+DECKER™ and the Black & Decker® and BLACK+DECKER™ logos are registered trademarks of The Black & Decker® Corporation and are used under licence. All rights reserved. Imported and Distributed by RKW LTD, Sutton House, Berry Hill Industrial Estate, Berry Hill Road, Stoke-on-Trent, ST4 2NL