

Storage Shed Owner Manual & Assemble Guide_SS16358

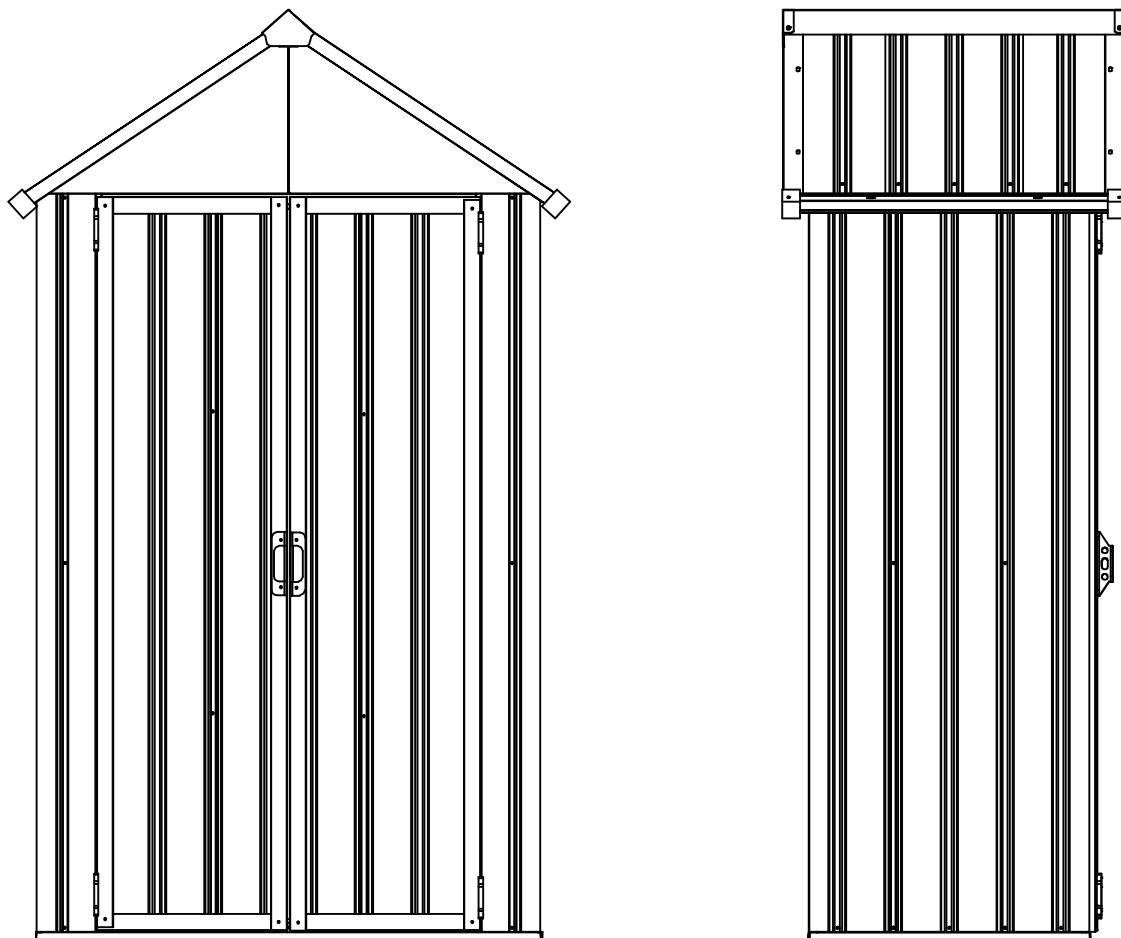



Customer Service:

If you have any problem, please contact us through the online platform.

All parts are packed in one box, please note that refer to the parts list to check if all parts are received.

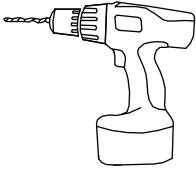
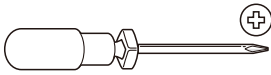
Please prepare below tools before installation. (Not Included)

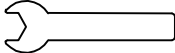
 Electric Screwdriver	 + Manual Screwdriver	 Ladder
Package included Tools	 Gloves x 1Pair	 Spanner x 1

ATTENTION

Care **MUST** be taken when handling various pieces of your building since many contain sharp edges.

Do NOT attempt to assemble your building before double checking that you have all parts indicated in the parts lists. Any building left partially assembled may be seriously damaged by even light winds.

Do NOT attempt to assemble your building on a windy day, the large panels can catch the wind like a “sail”, making construction difficult and unsafe. **Watch the weather closely.** Keep children and pets away from the worksite during construction and until the building is completely assembled. This will help avoid distractions and any accidents which may occur. Never concentrate your weight on the roof of the building.

Before assembling any parts, your base should be constructed and an anchoring system should be ready to use. Your building must be anchored to prevent wind damage.

ASSEMBLY

The best location is a level area with good drainage.

Allow enough space outside the building to be able to access the roof with a ladder.

USE TEAMWORK: Two or more people are required to assemble your building.

CARE & MAINTENANCE

Do NOT use power washing to clean your shed.





















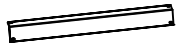

Combustibles and corrosives must be stored in air tight containers designed for chemical and/or combustible storage.











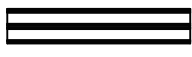











Rust Protection Precautions

Avoid nicking or scraping the coating surface, inside and out.

PLEASE KEEP THIS INSTRUCTION FOR FUTURE REFERENCE.

Part List

PART	NO.	QTY.
	T12	2
	K24-1	2
	C23-2	2
	K23-3	2
	K24-4	2
	K24-5L	2
	K24-5R	2
	K23-6	2
	K24-6	1
	K24-11	4
	K23-12	2
	K23-13	1
	K23-10	4
	K24-13	2
	K24-8	8
	K24-9	2
	K24-10	10
	K26ULA	2
	K26DLA	2
	K24DA	2
	C13-DDA	4
	K24DBA	4
	GE-1	2

PART	NO.	QTY.
 }	K23W3-C	4
 }	K23W3	4
 }	K23W3-B	2
 }	K24W3-K	2
 }	K24W2-HLR	2
	K24-7L	2
	K24-7M	2
	K24-7R	2
	C3	4
	C17	1
	GC	4
	T-F	4
	F1	231
	F2	43
	F8	8
	V2	40
	C2	4
	DJ	4
	C15	12
	GB	2
	CT	8
	M4	1
	ST	2

NOTE: This is **not the beginning** of the installation steps; it is merely to indicate where each component will be installed.

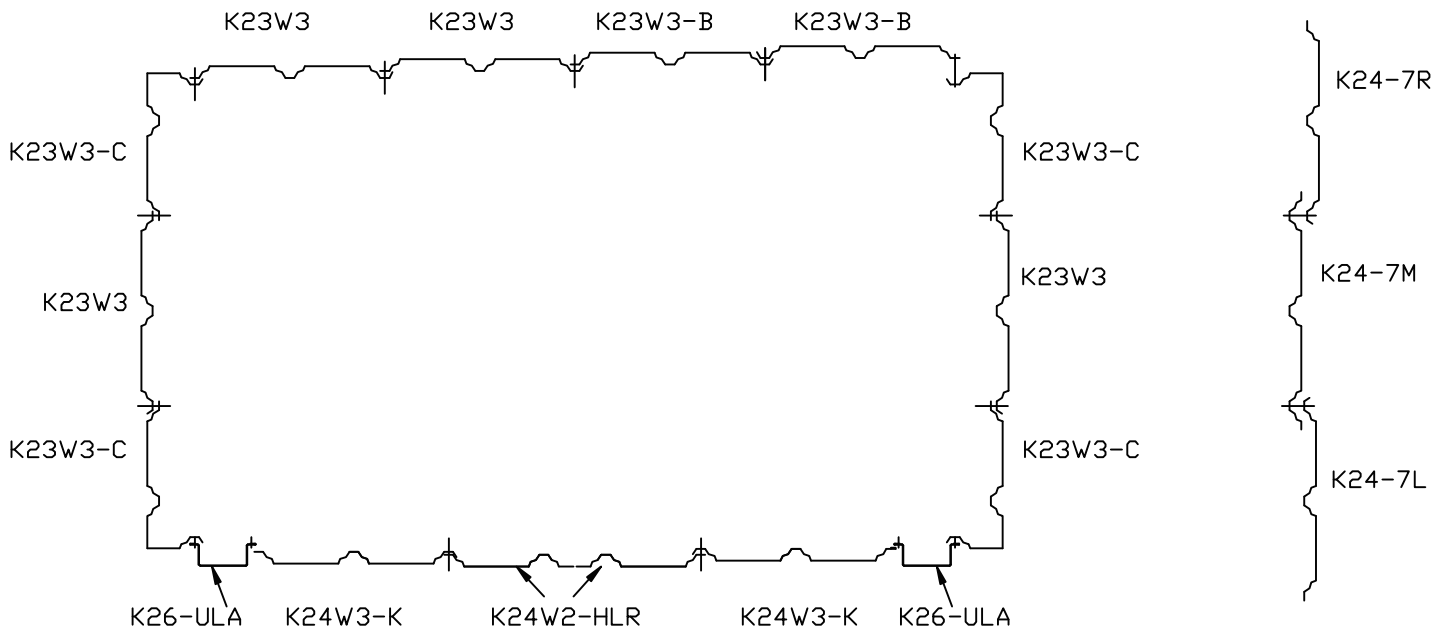



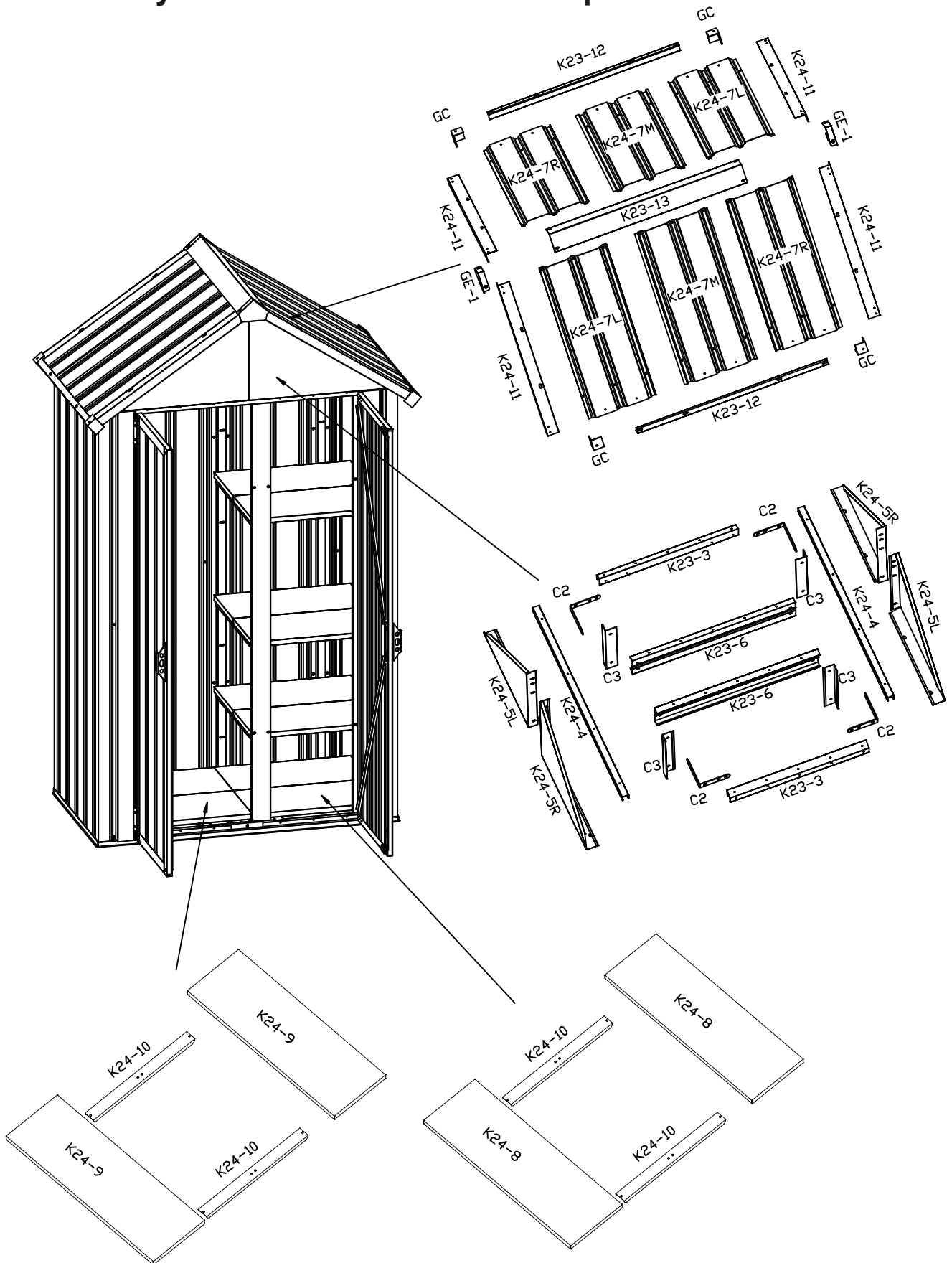

Part List

NOTE: This is **not the beginning** of the installation steps; it is merely to indicate where each component will be installed.



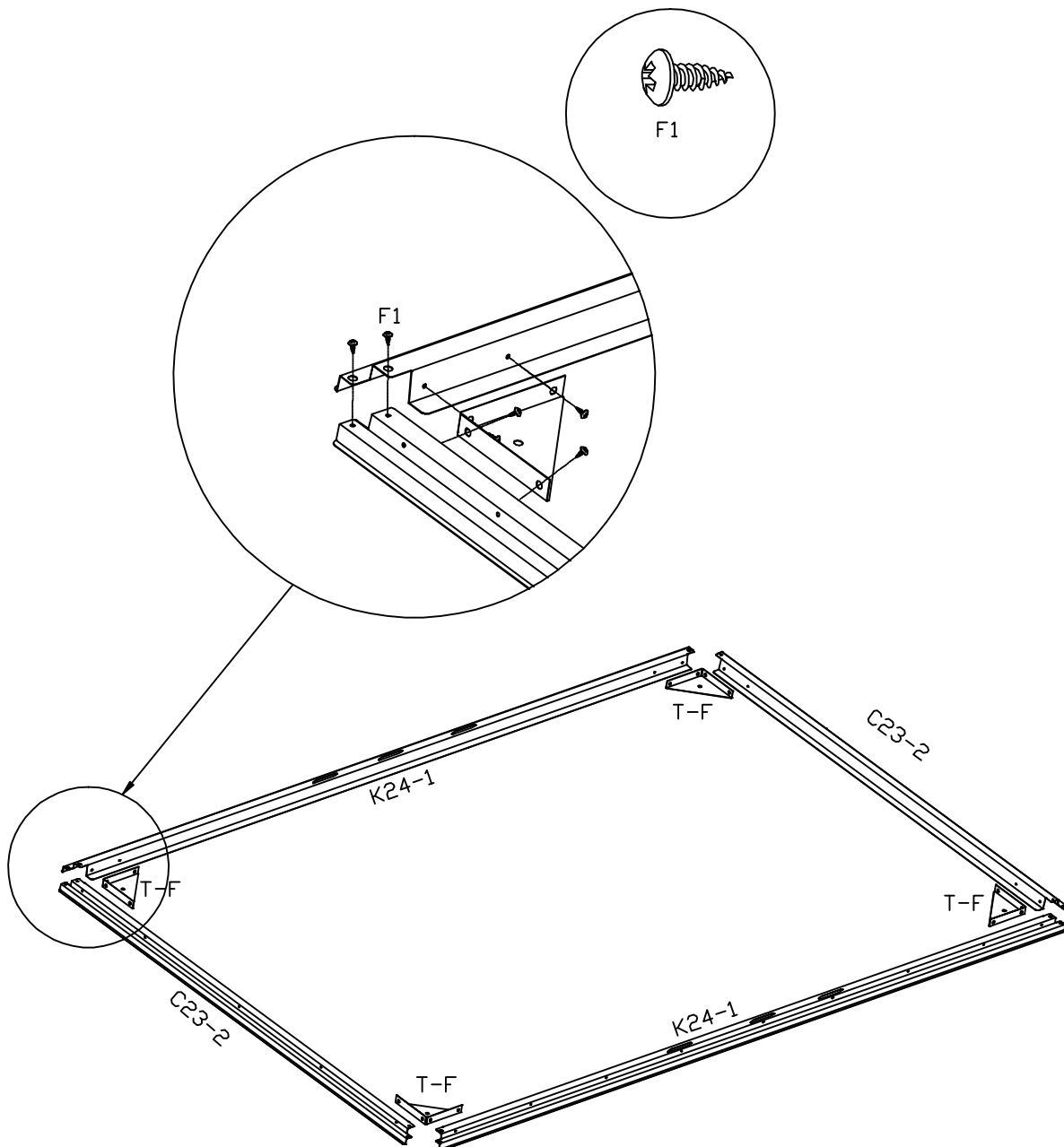

Side Panel Assemble

PART	NO.	QTY.
	K24-1	2
	C23-2	2
	T-F	4
	F1	24

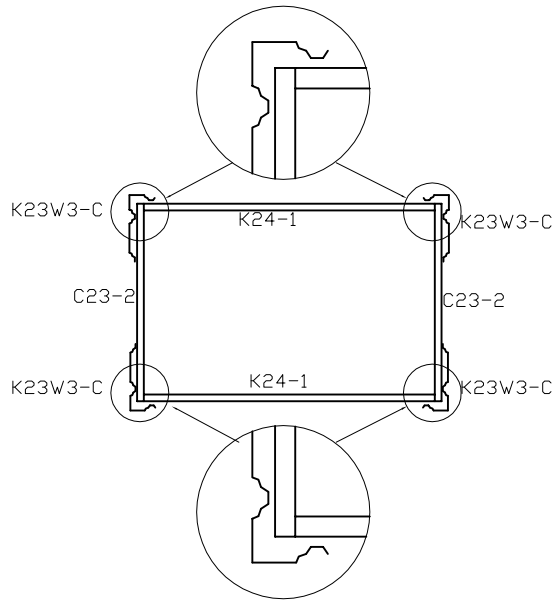

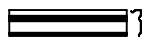



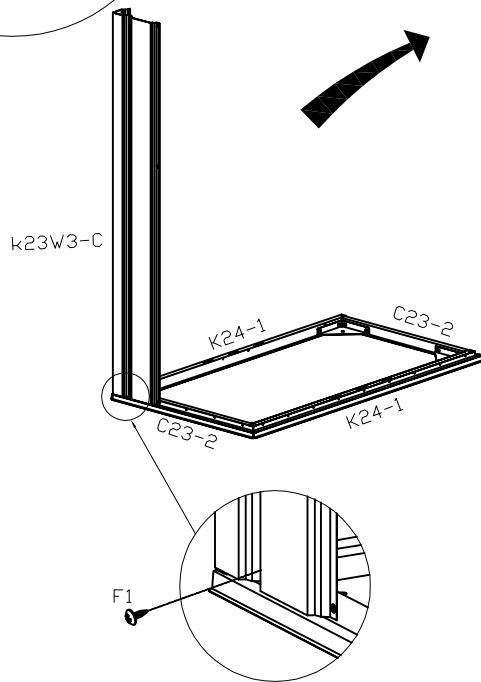
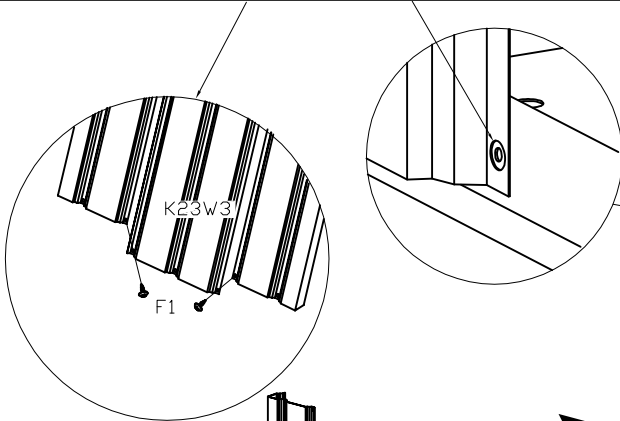
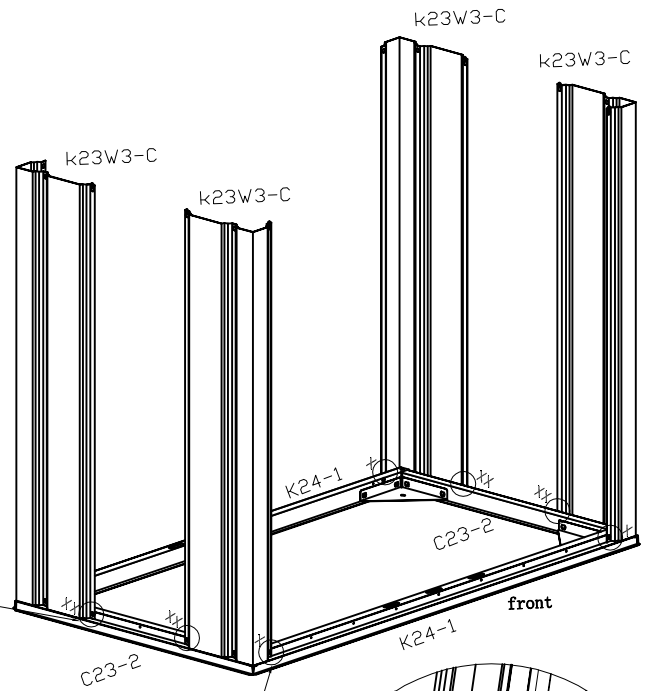

PART	NO.	QTY.
	K23W3-C	4
	F1	4

There is no need to install the F1 screw at the XX location for now.
The hole position here should be installed together with K23W3 on page 12.

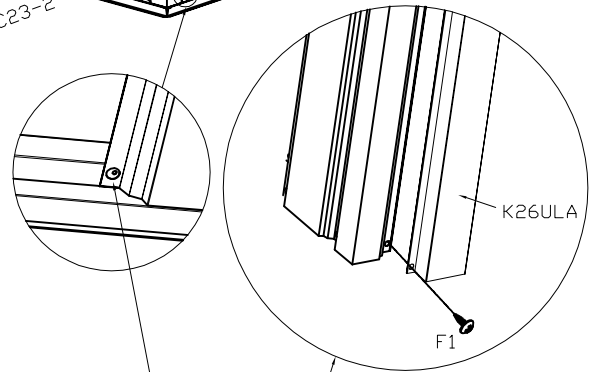

There is no need to install the F1 screw at the X location first.
The hole position here should be installed together with K26ULA on page 13.



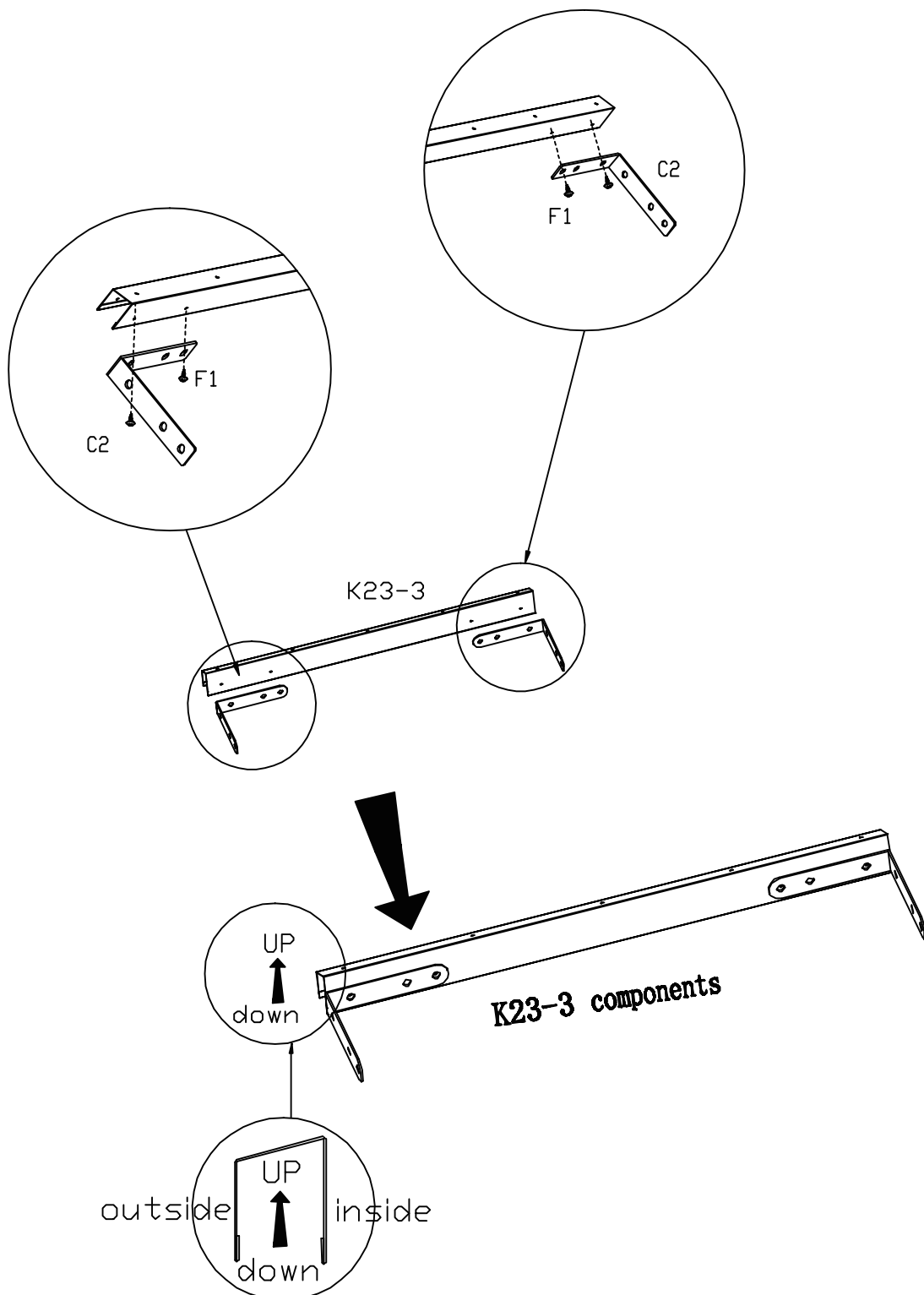

PART	NO.	QTY
	K23-3	2
	C2	4
	F1	8

2 groups



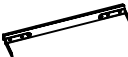

Top Panel Assemble

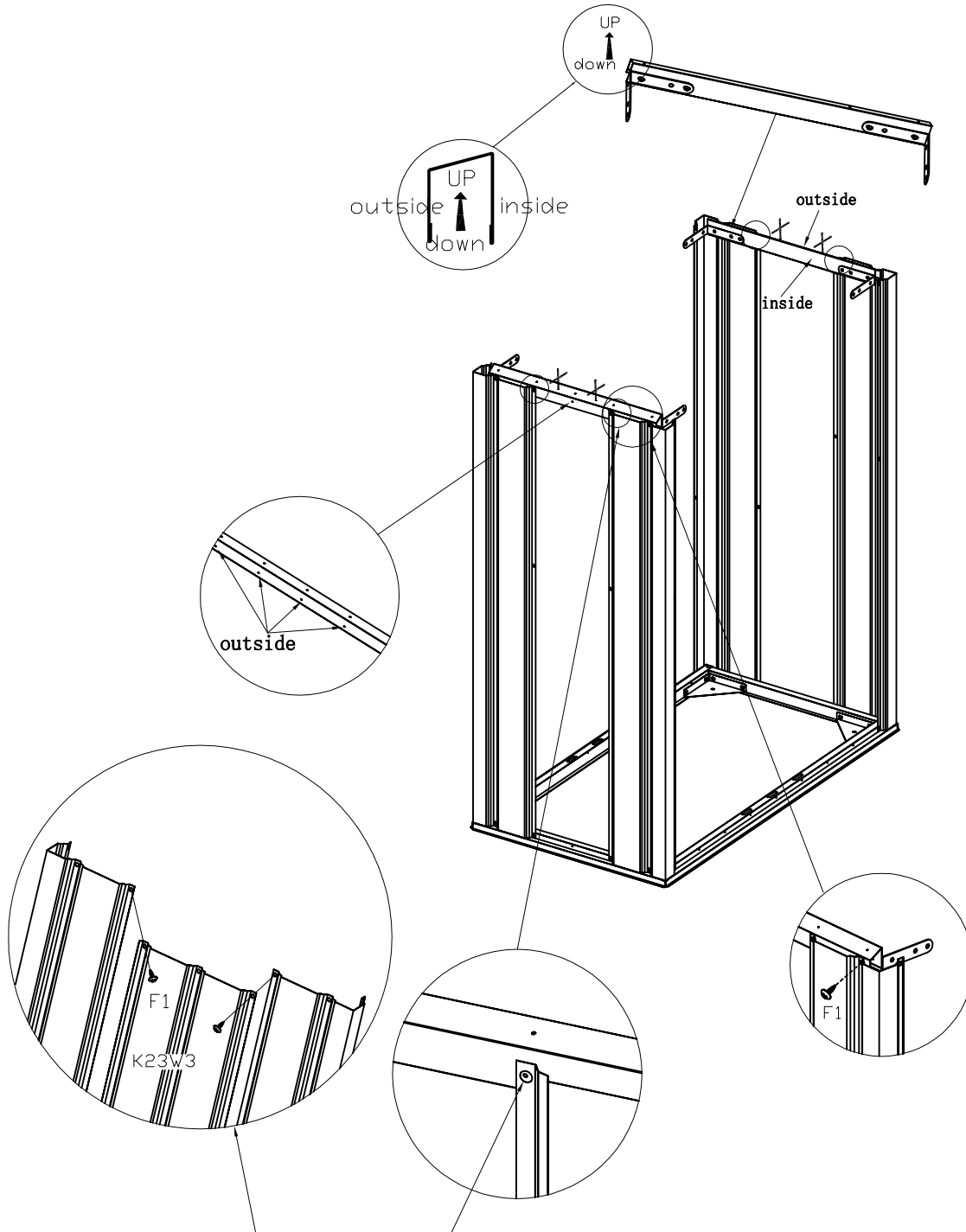
PART	NO.	QTY
	K23-3 components	2
	F1	4

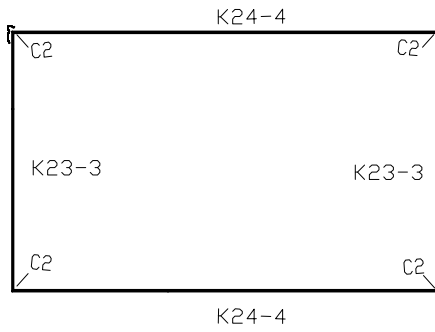

There is no need to install the F1 screw at the X location for now.
The hole position here should be installed together with K23W3 on page 12.





PART	NO.	QTY
	K24-4	2
	F1	8

There is no need to install the F1 screw at the XX location first.
The hole position here should be installed together with K23W3-B on page 17.

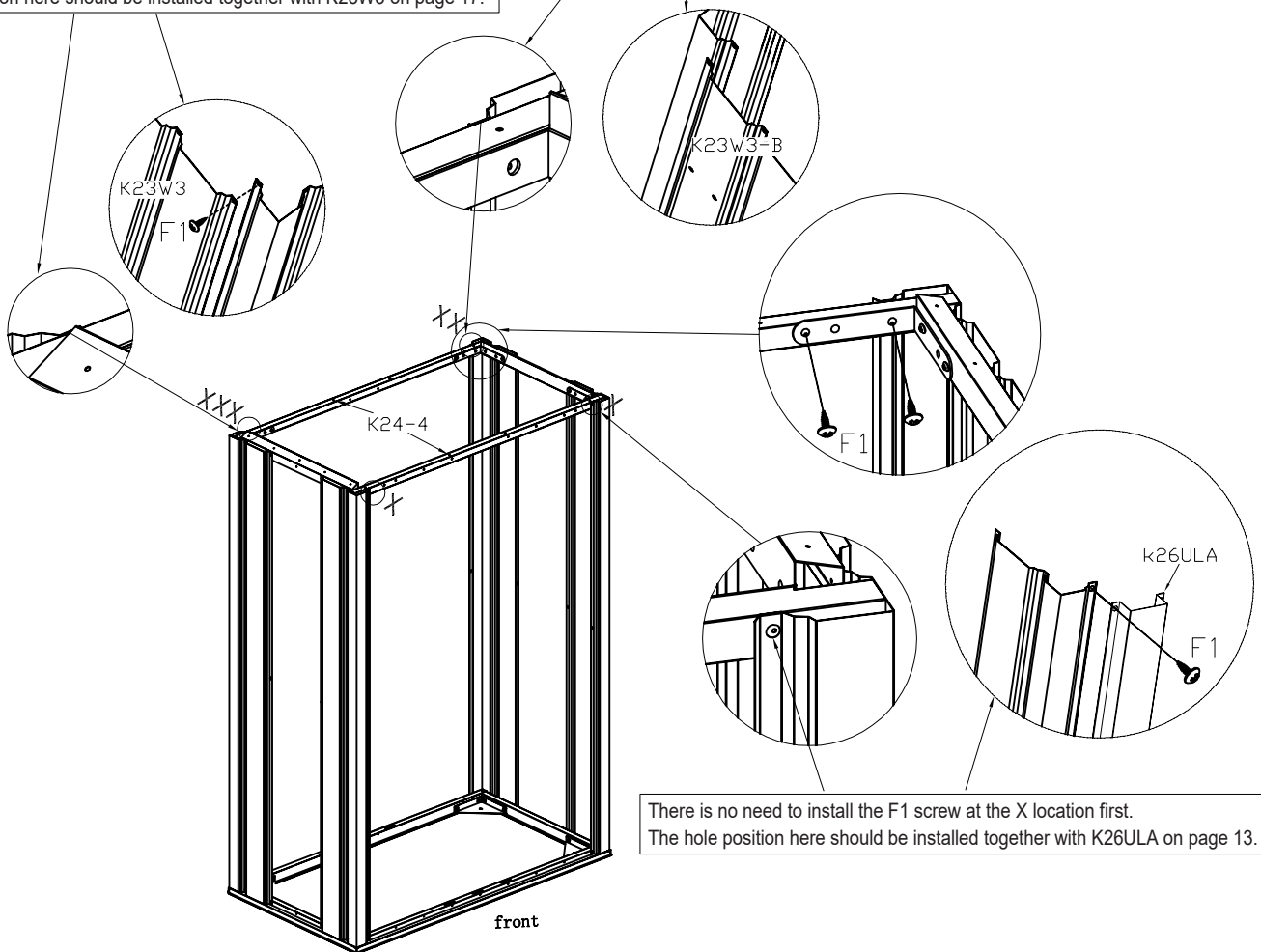
There is no need to install the F1 screw at the XXX location first.
The hole position here should be installed together with K23W3 on page 17.



There is no need to install the F1 screw at the X location first.
The hole position here should be installed together with K26ULA on page 13.

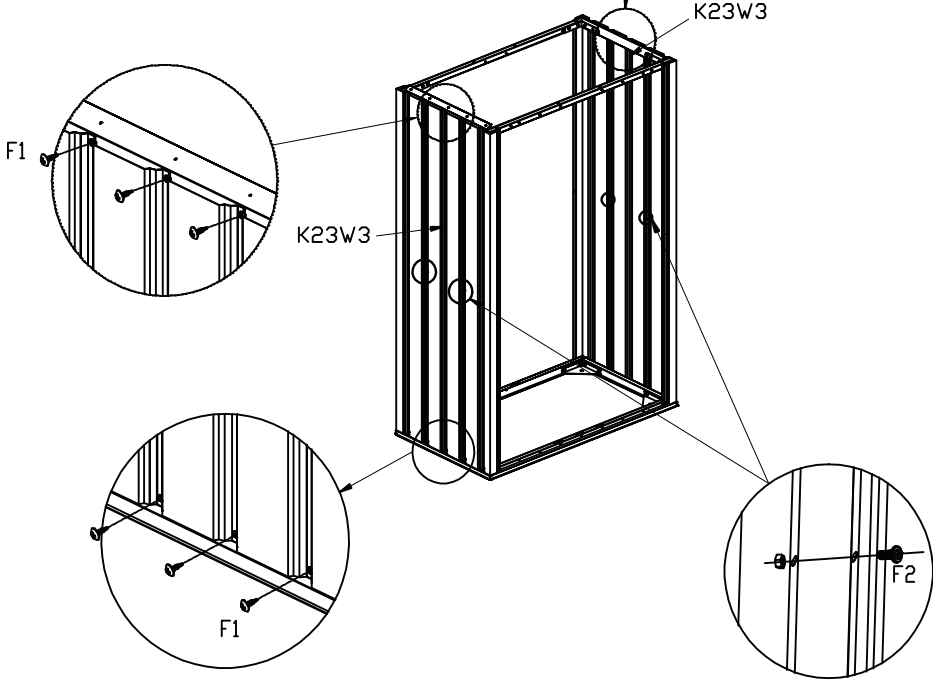
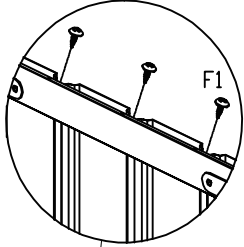
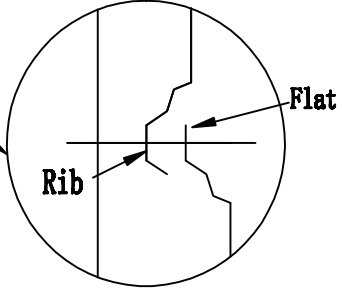
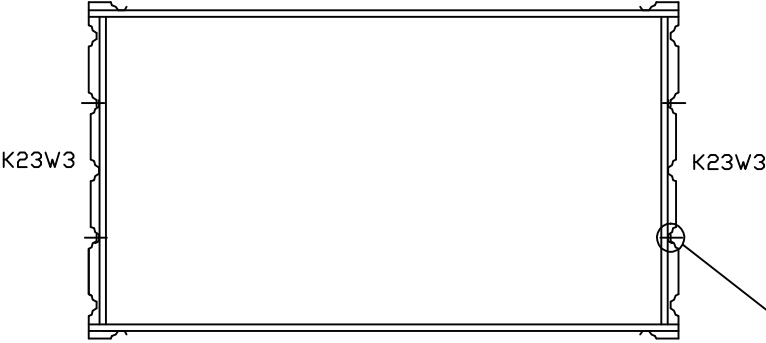

PART	NO.	QTY
	K23W3	2
	F1	12
	F2	4

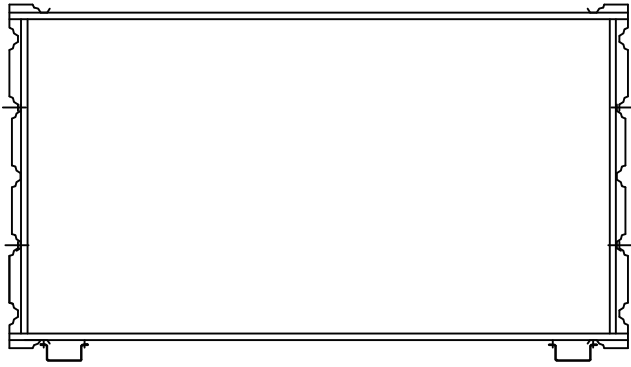



K26ULA

K26ULA

PART	NO.	QTY.
	K26ULA	2
	F1	8
	F2	2

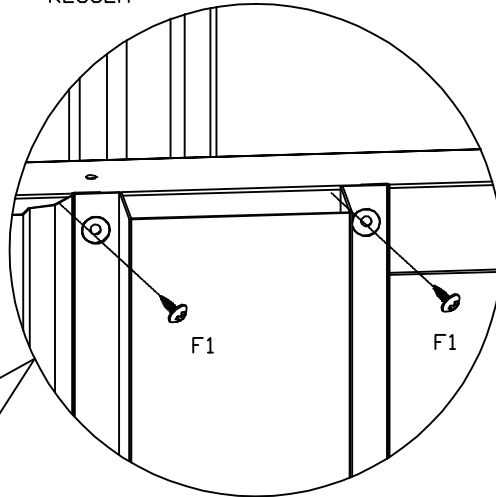

F1

F1

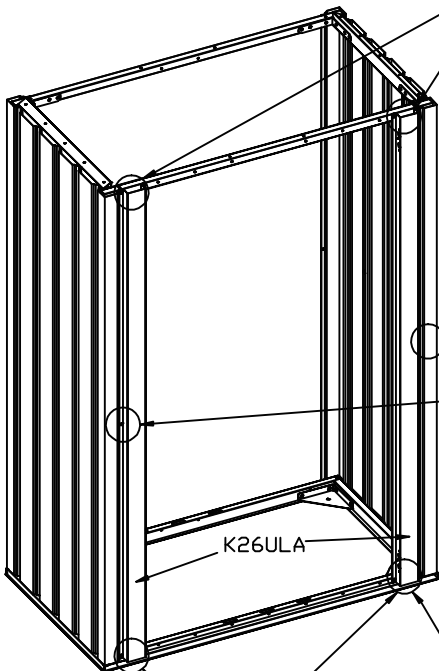

K26ULA

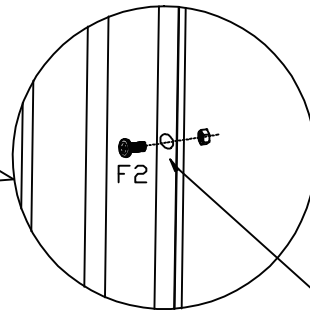

F2

Attention:

When assembling K26ULA pay attention to the direction, Assemble the F2 screw with the hole in the middle of the textured board on one side.

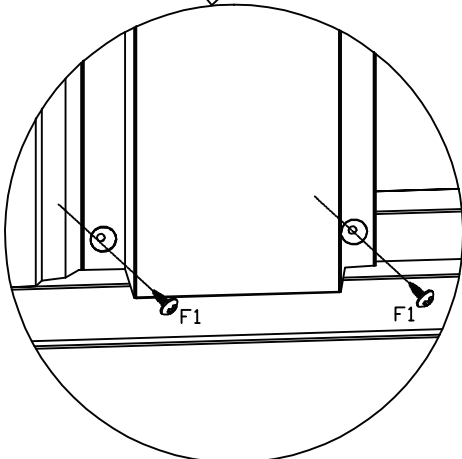



F1

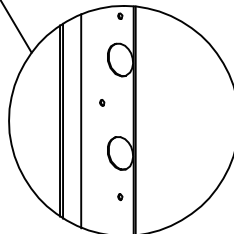

F1





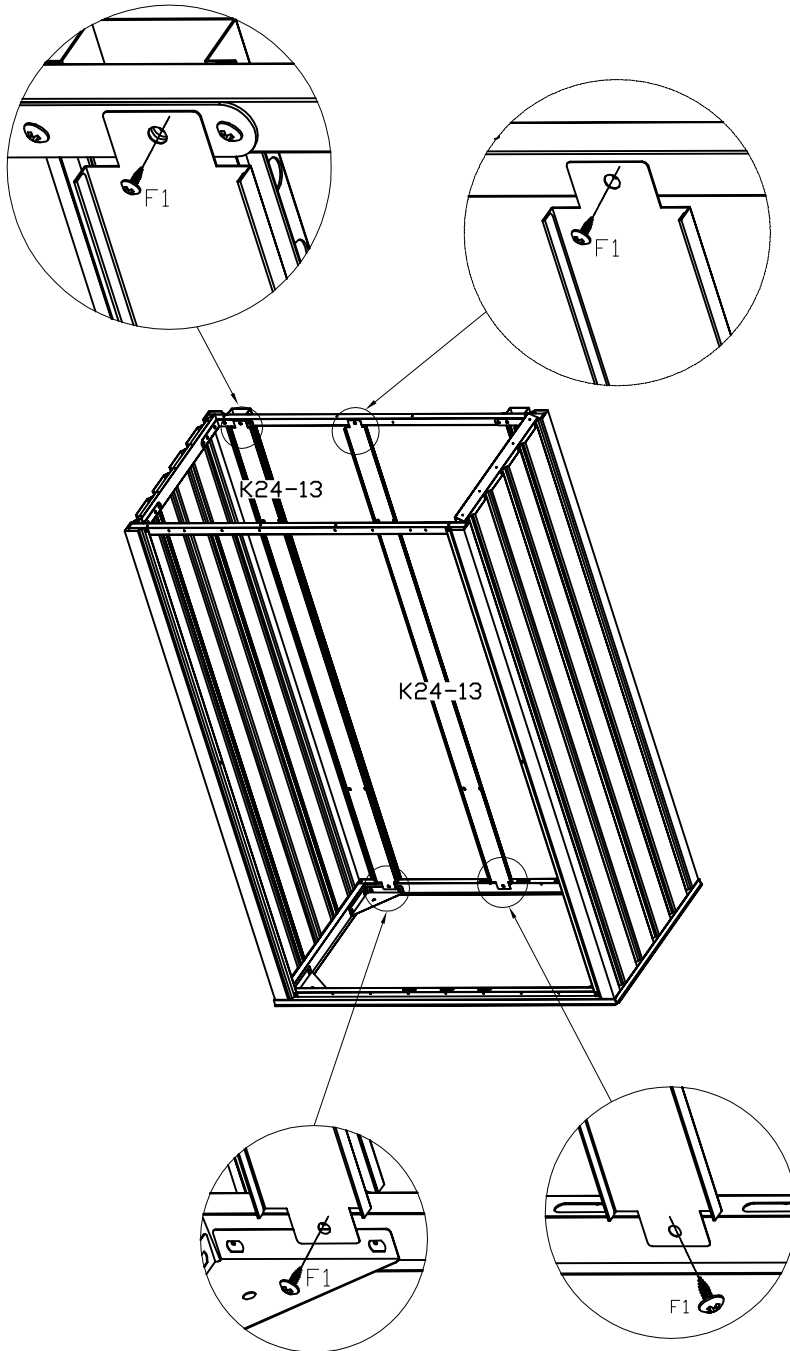

The inner side is a hinge installation hole.

PART	NO.	QTY.
	K24-13	2
	F1	4

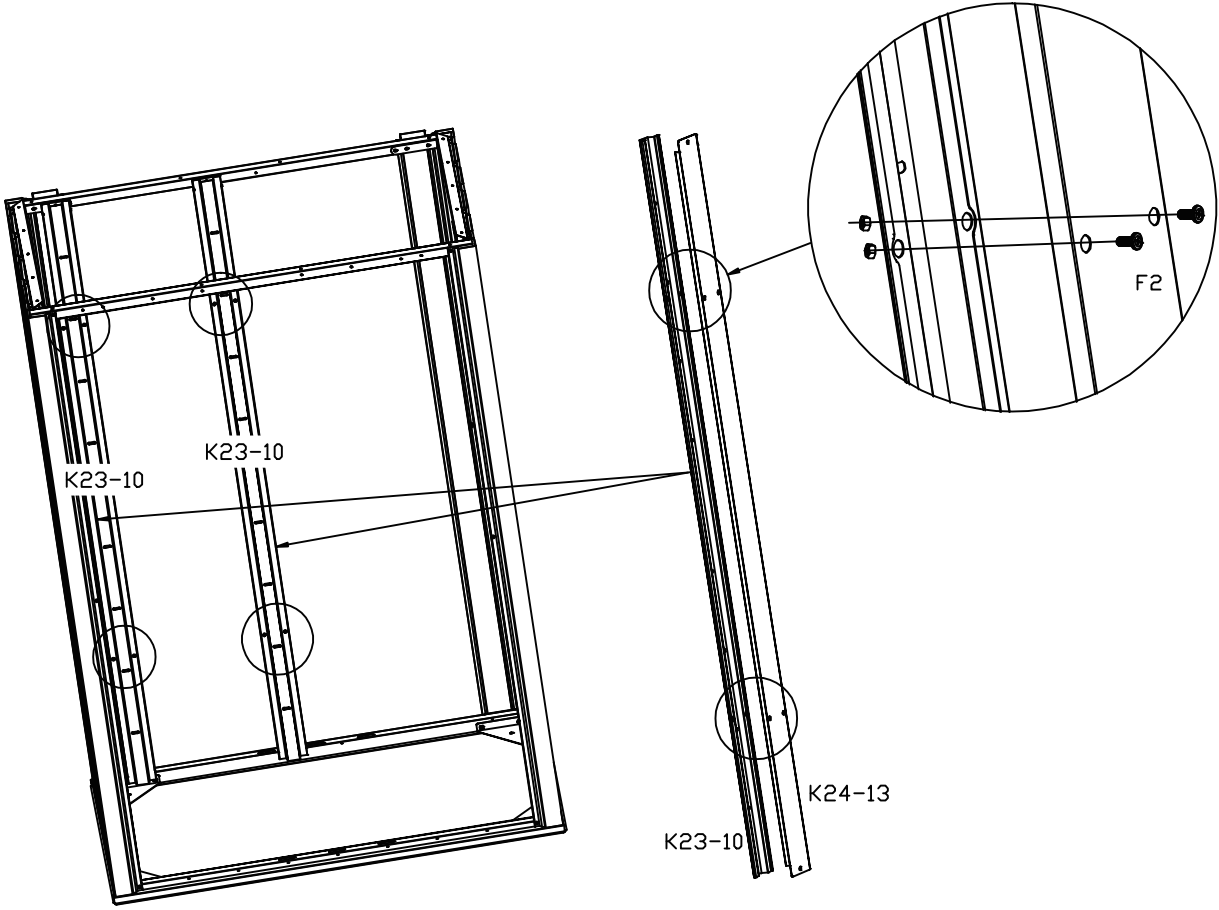





PART	NO.	QTY.
	K23-10	2
	F2	8

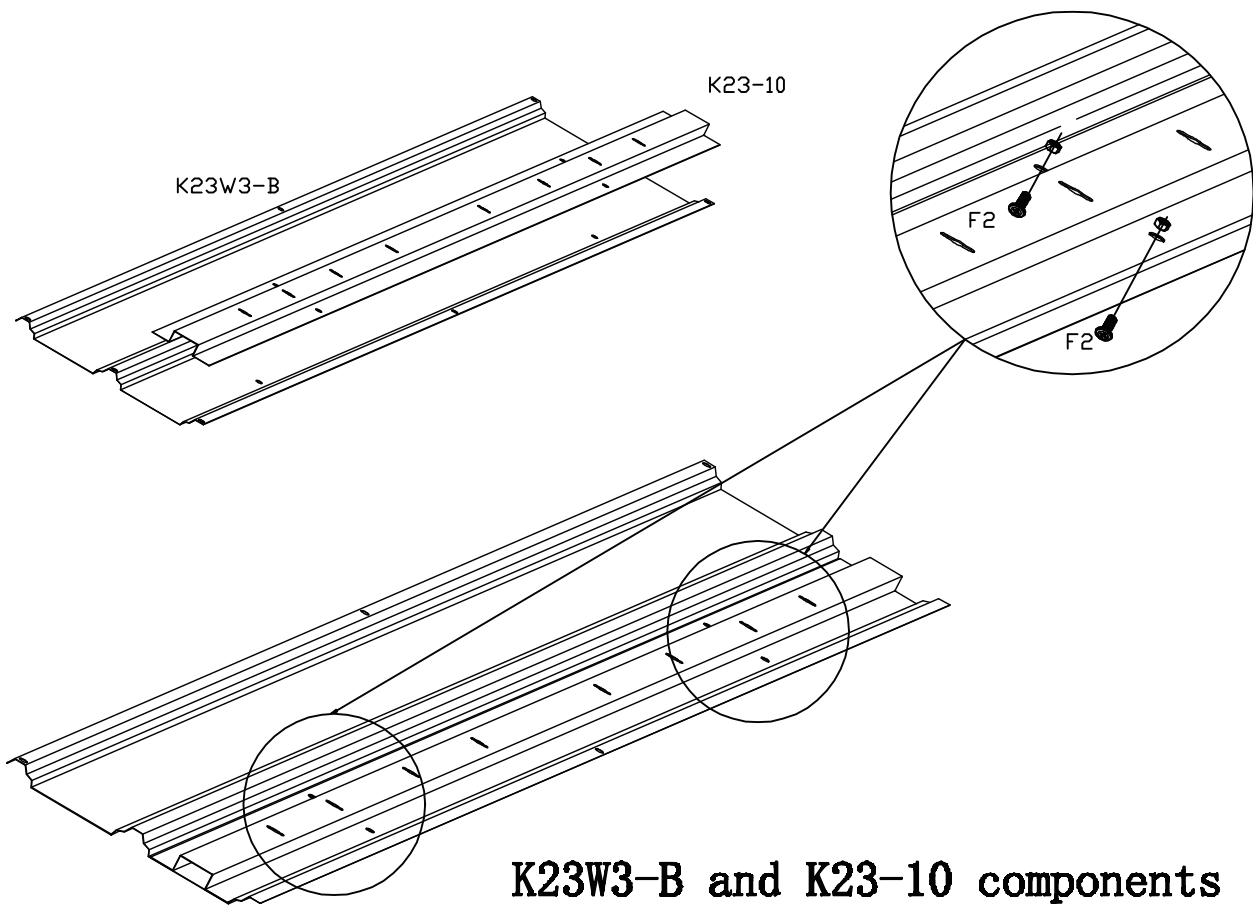

PART	NO.	QTY.
	K23W3-B	2
	K23-10	2
	F2	8

2 groups



PART	NO.	QTY.
	K23W3	2
	K23W3-B and K23-10 components	2
	F1	18
	F2	5

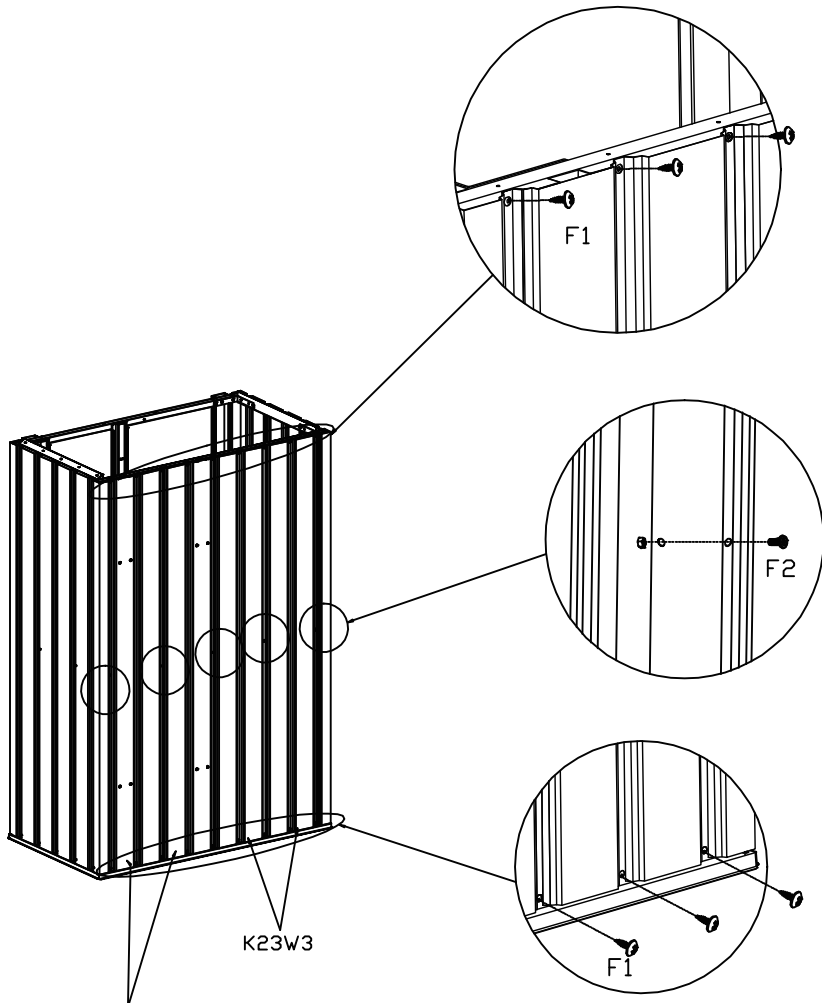
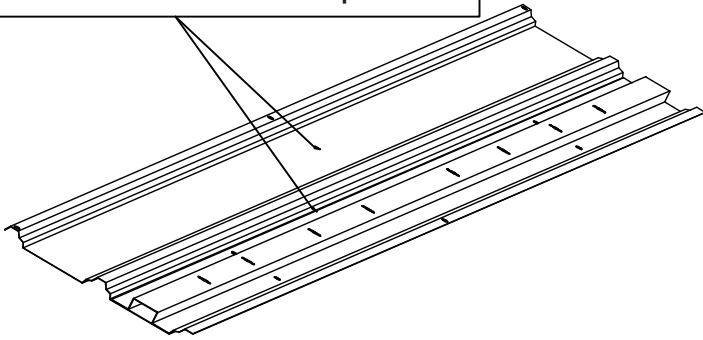

K23W3-B and K23-10 components



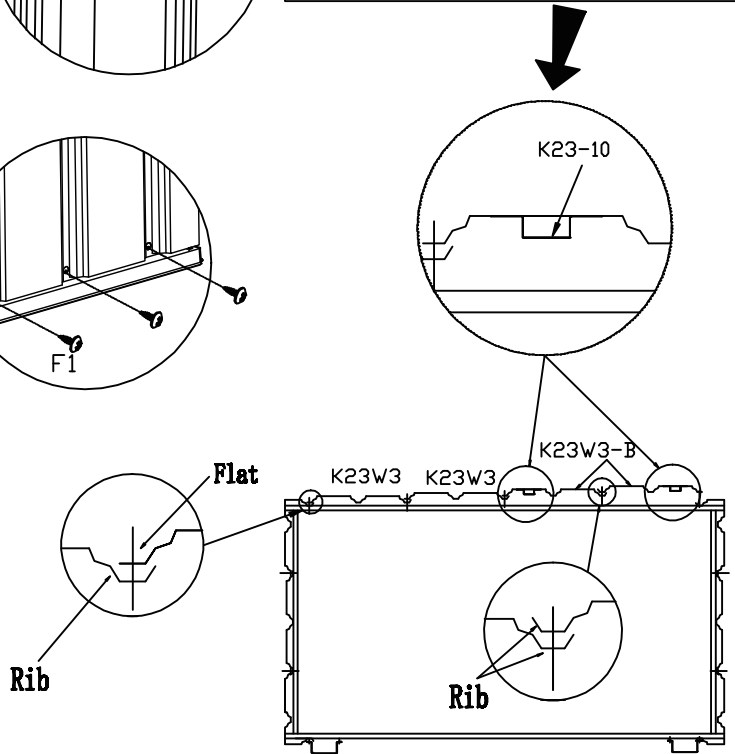

K23W3-B and K23-10 components

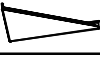
As shown in the figure:
Pay attention to the installation direction of K23W3-B
and K23-10 components,
which must be installed according to the diagram.



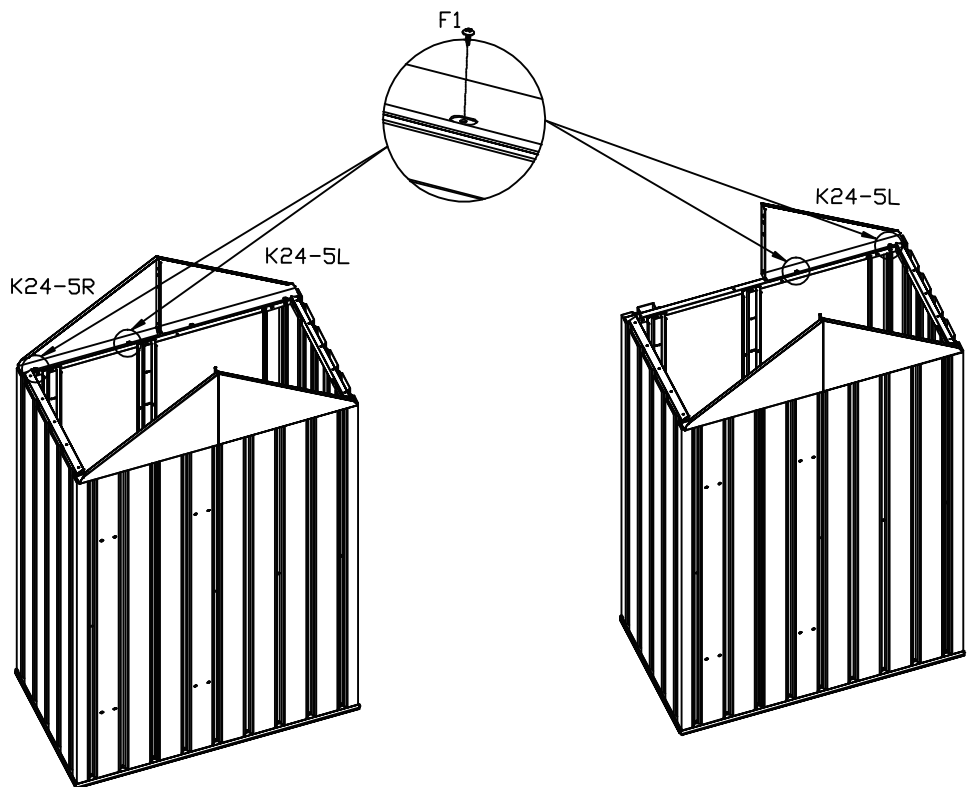
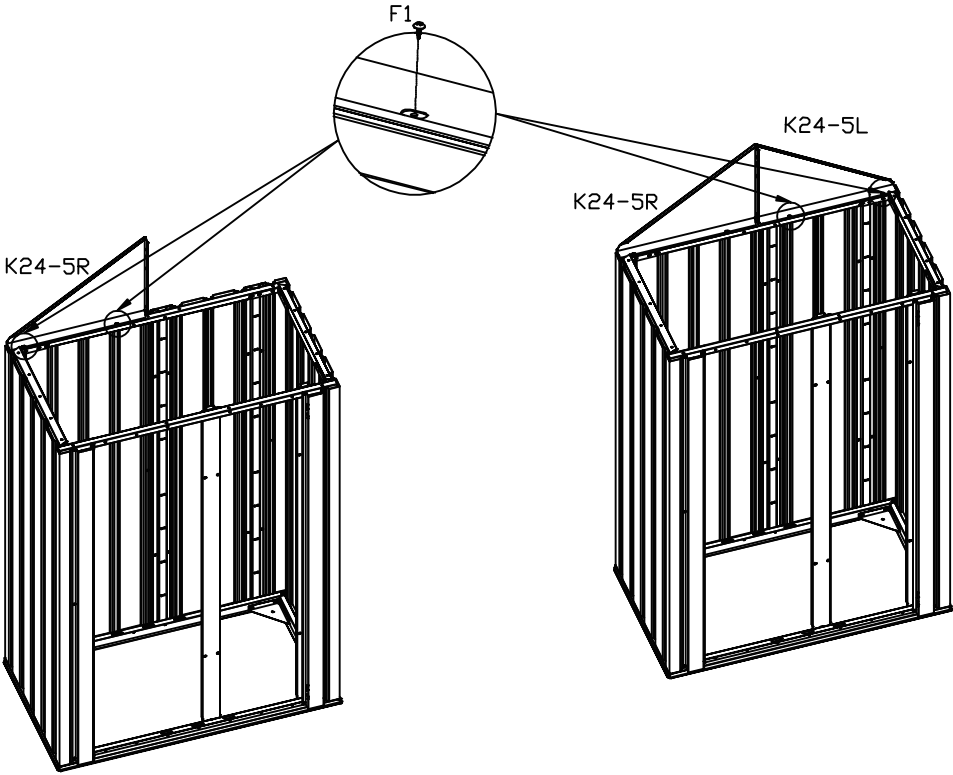

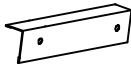
PART	NO.	QTY.
	K24-5L	2
	K24-5R	2
	F1	8



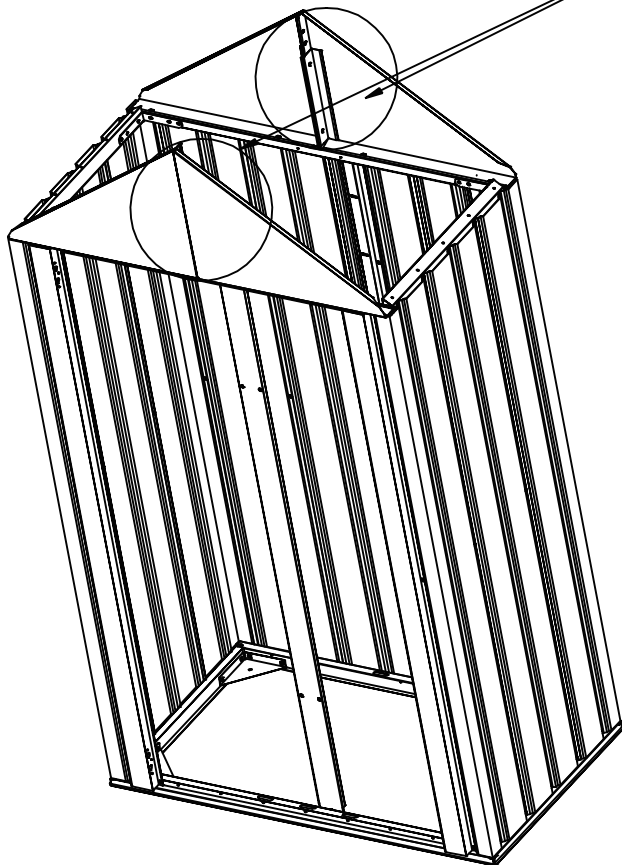
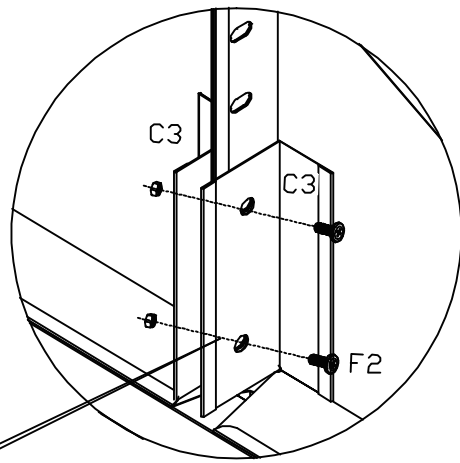
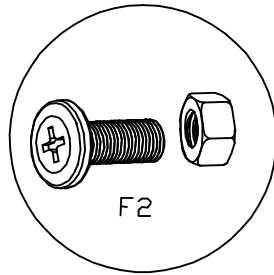





PART	NO.	QTY.
	C3	4
	F2	4

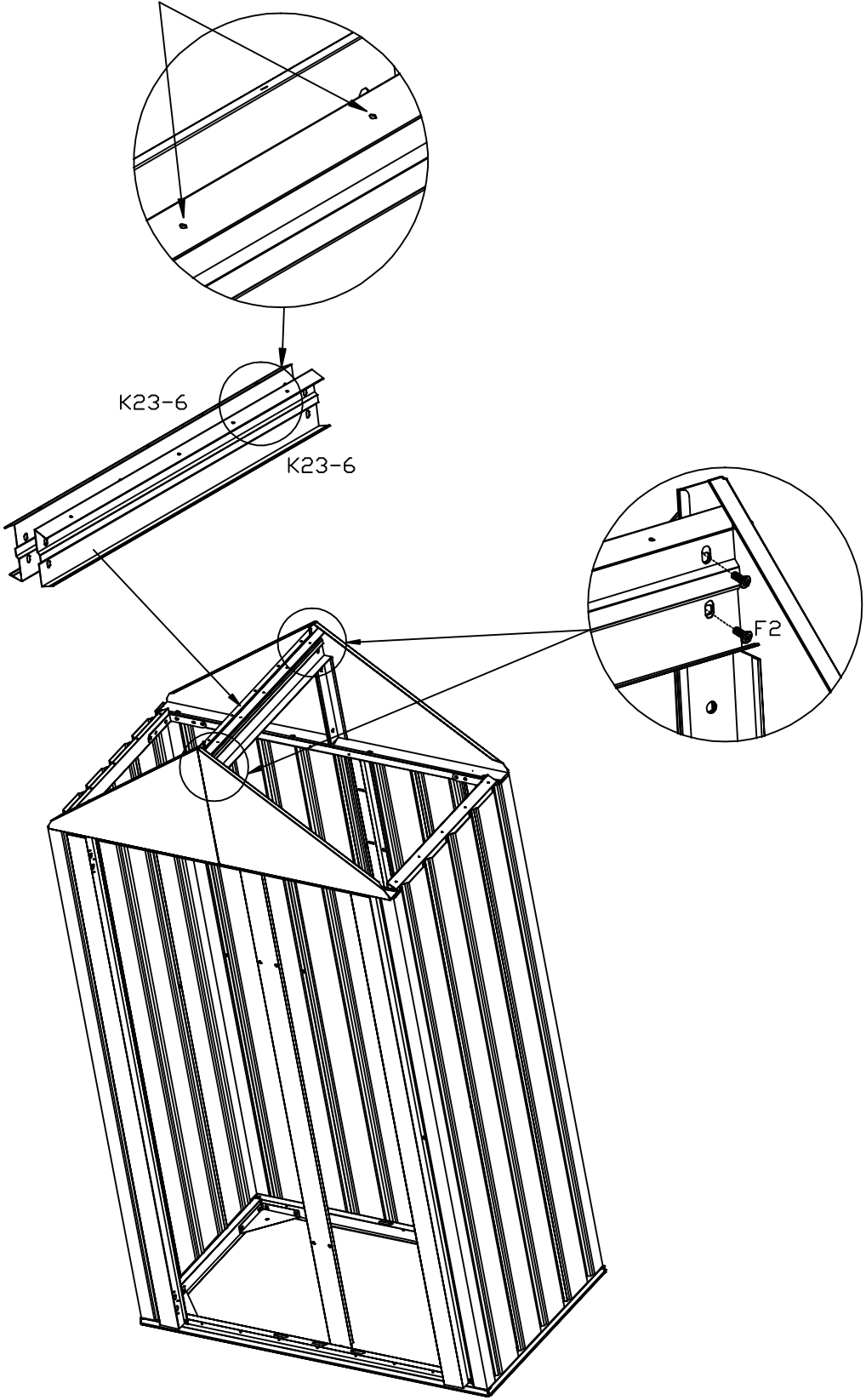

PART	NO.	QTY.
	K23-6	2
	F2	4

There are holes on top.



PART	NO.	QTY.
	K24-7L	2
	K24-7M	2
	K24-7R	2
	F1	20
	V2	20

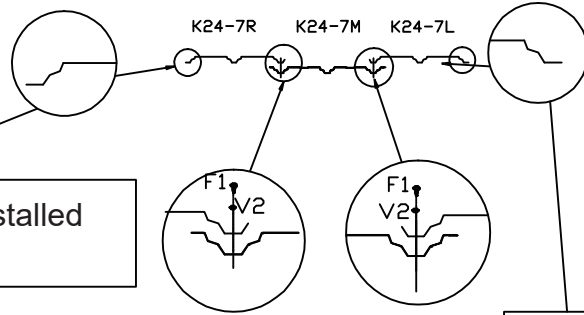

Fldt edge be installed with K24-11.

Fldt edge be installed with K24-11.

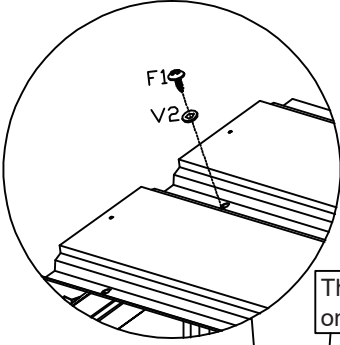

The small hole is on the outside.

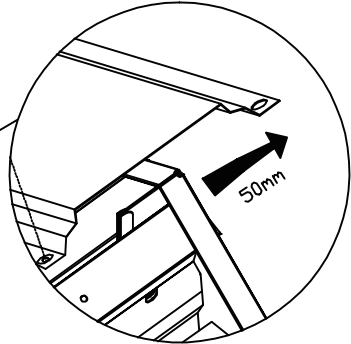
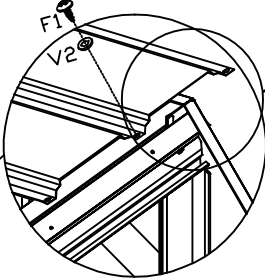

outside

Roof outward about 50mm.

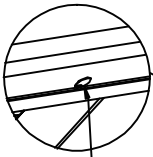



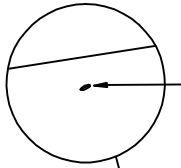

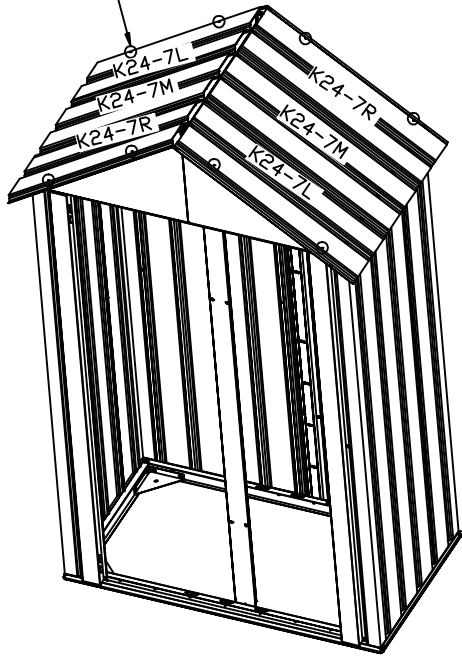
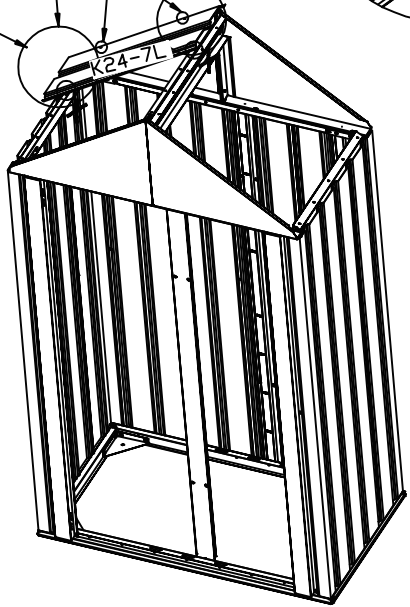

Do not add screws that indicated with an X in diagram These need to be left undone.



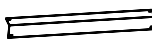



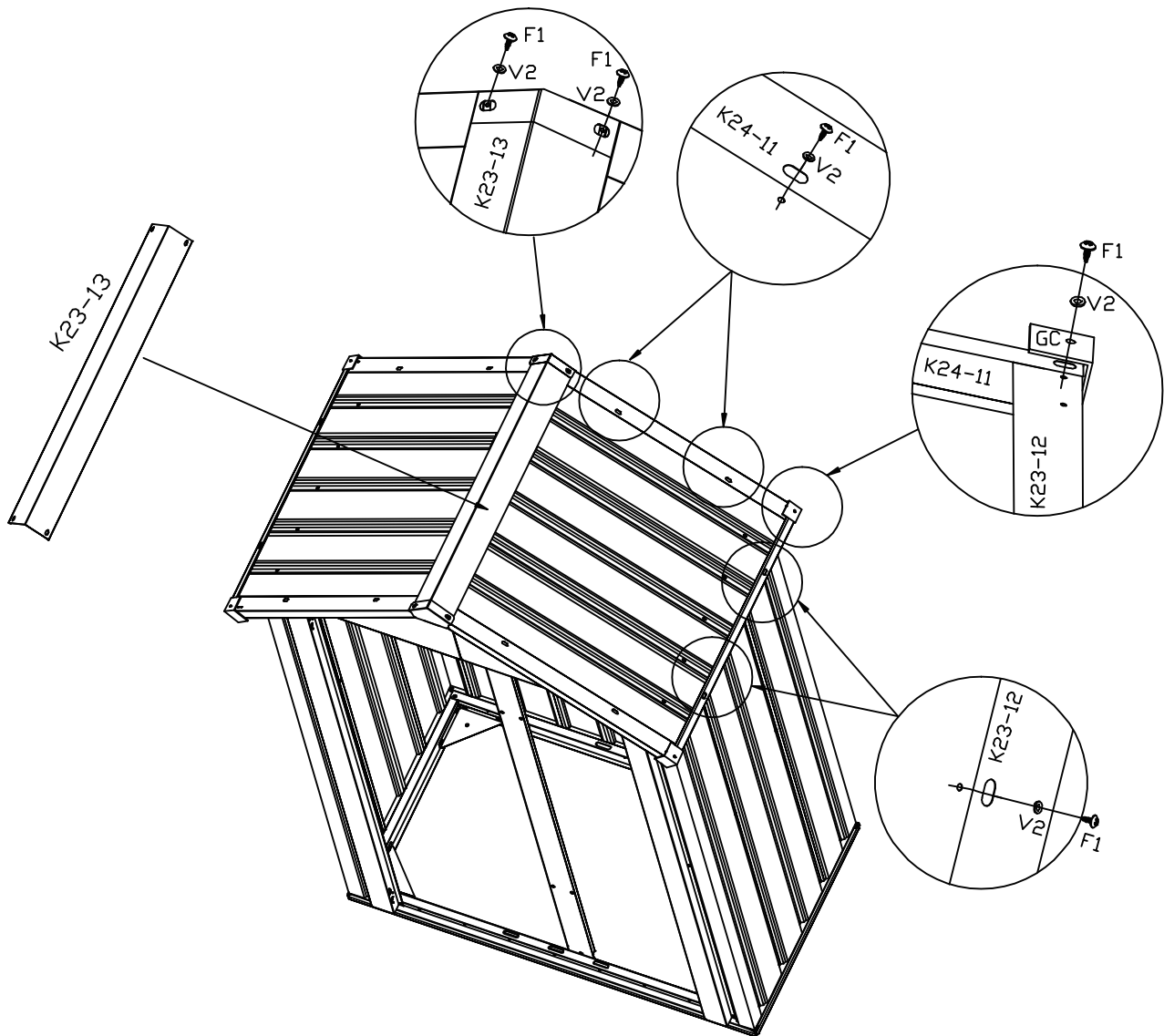
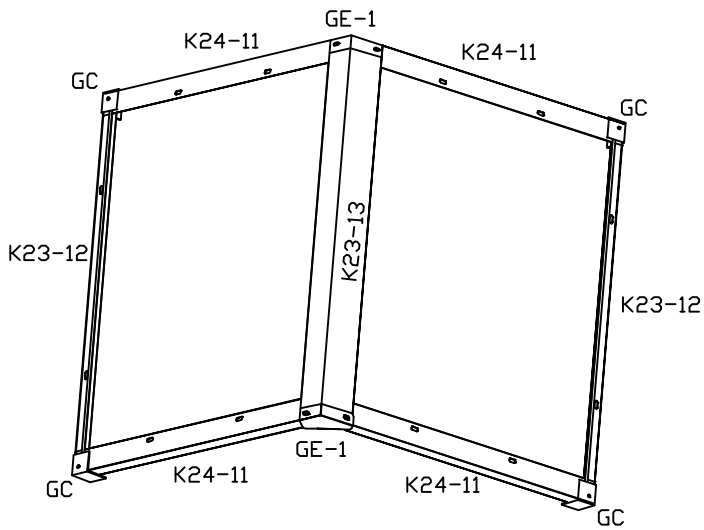

Flat edge with hole be installed outward to match the hone from K24-11.



PART	NO.	QTY.
	K24-11	4
	K23-12	2
	K23-13	1
	GE-1	2
	GC	4
	F1	20
	V2	20

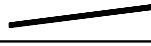

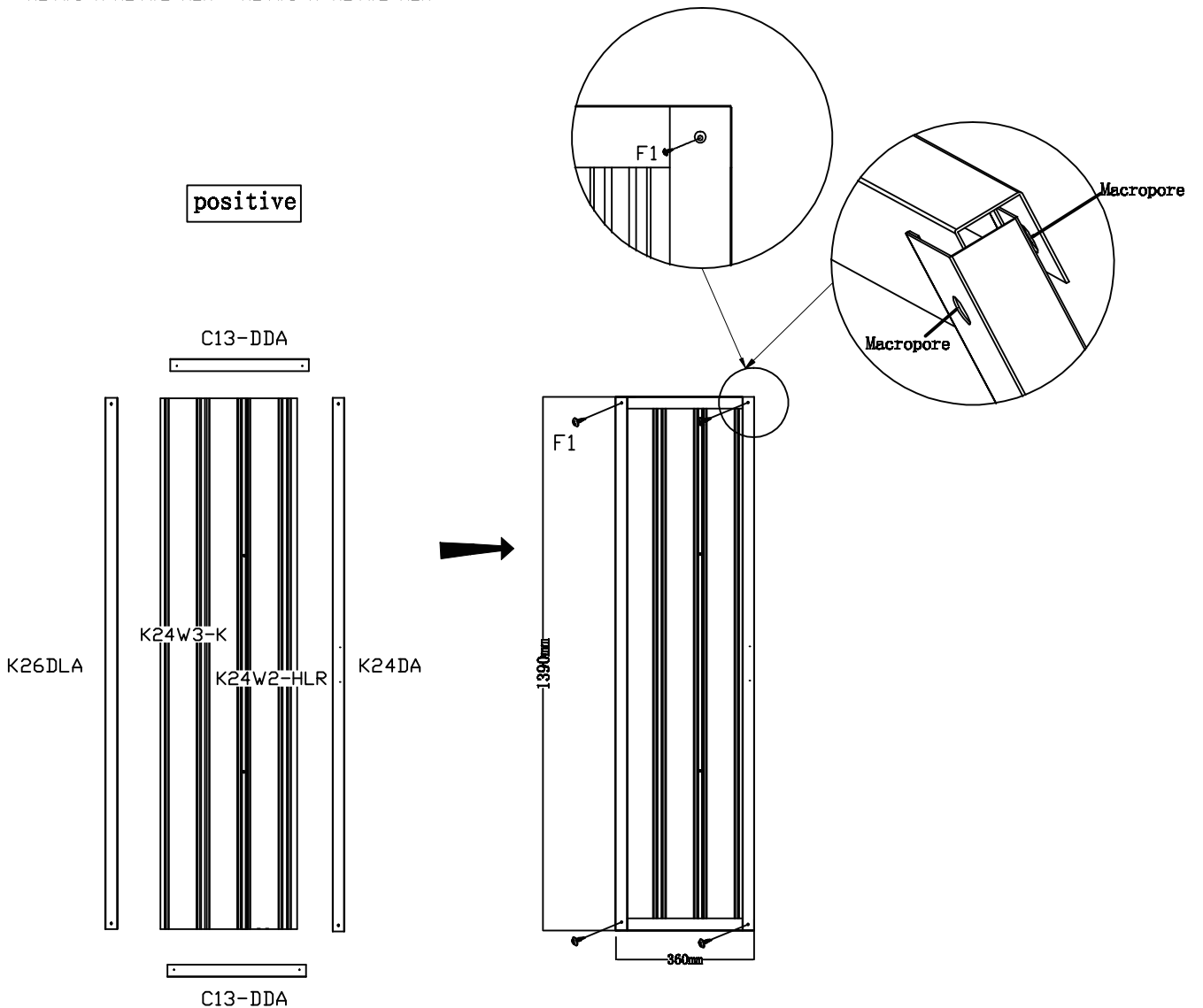
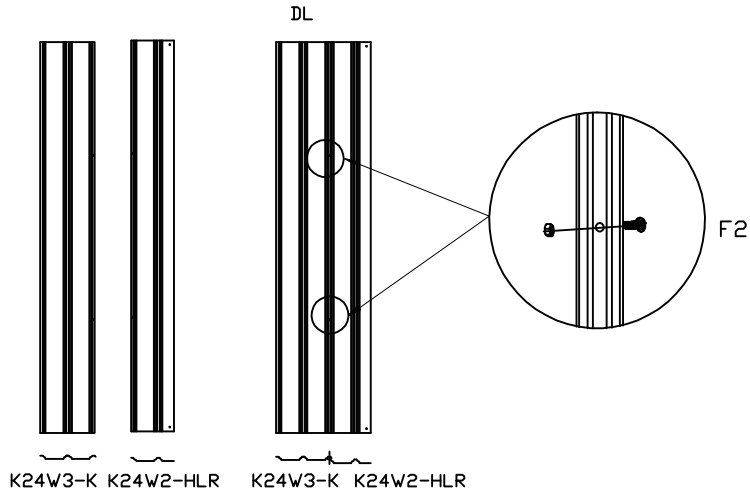

Left door panel splicing

PART	NL.	QTY.
	K24W3-K	1
	K24-W2HLR	1
	K26DLA	1
	K24DA	1
	C13-DDA	2
	F1	4
	F2	2



Left door panel splicing





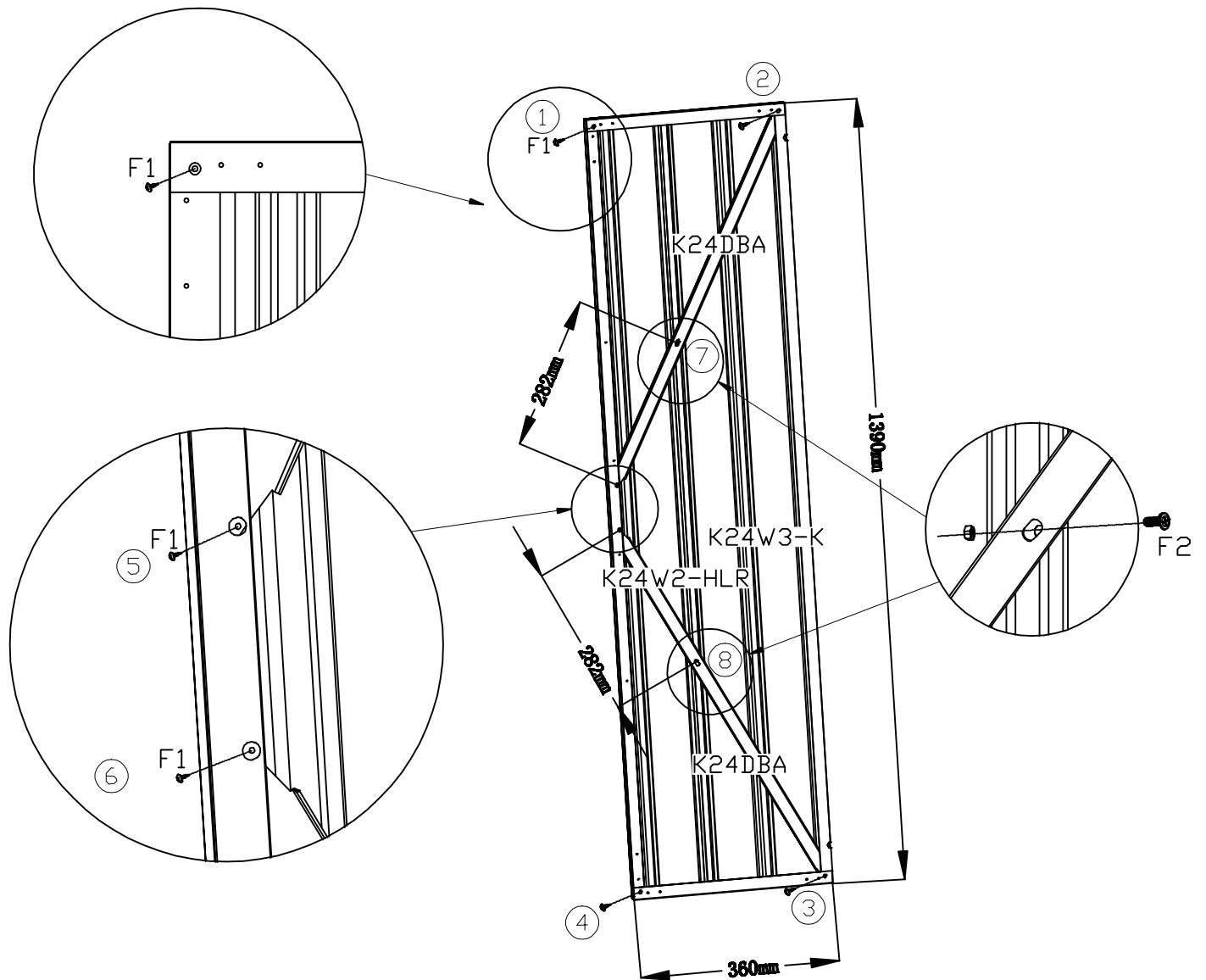

PART	NO.	QTY.
	K24DBA	2
	F1	6
	F2	2

Attention: Installation sequence of screws ① → ② → ③ → ④ → ⑤ → ⑥ → ⑦ → ⑧



back

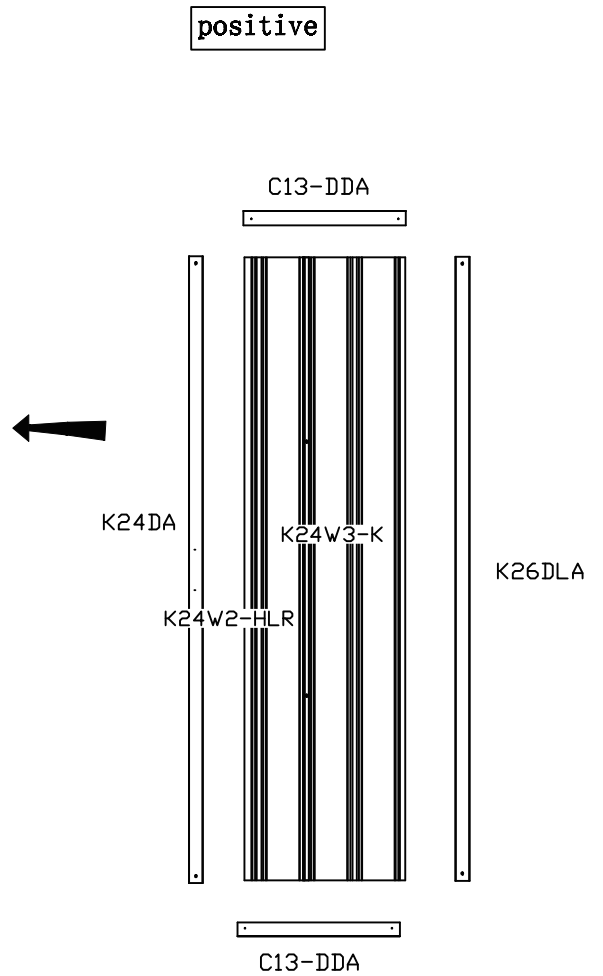
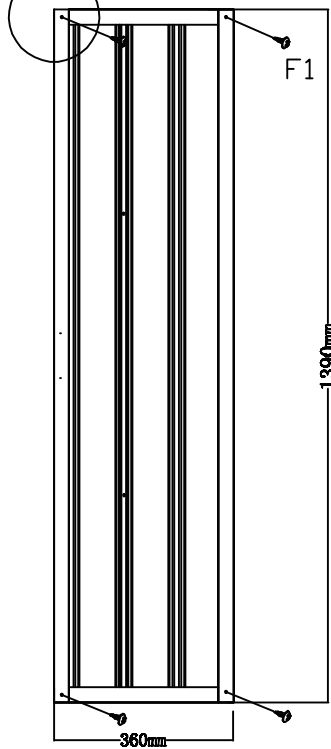
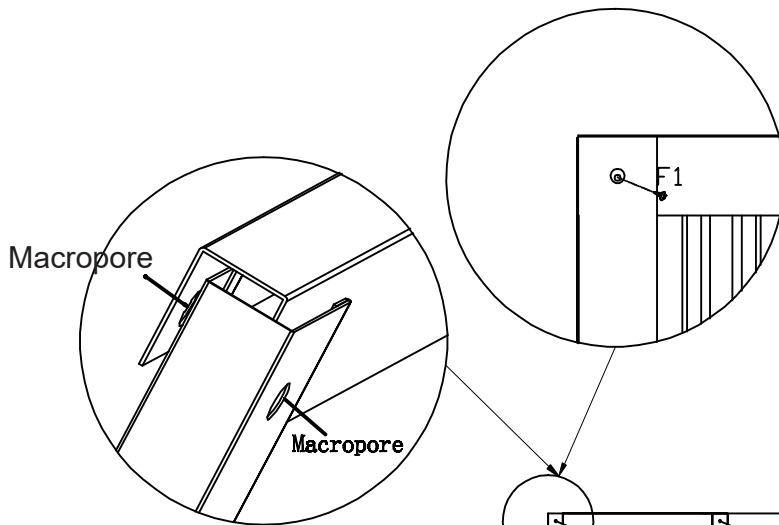
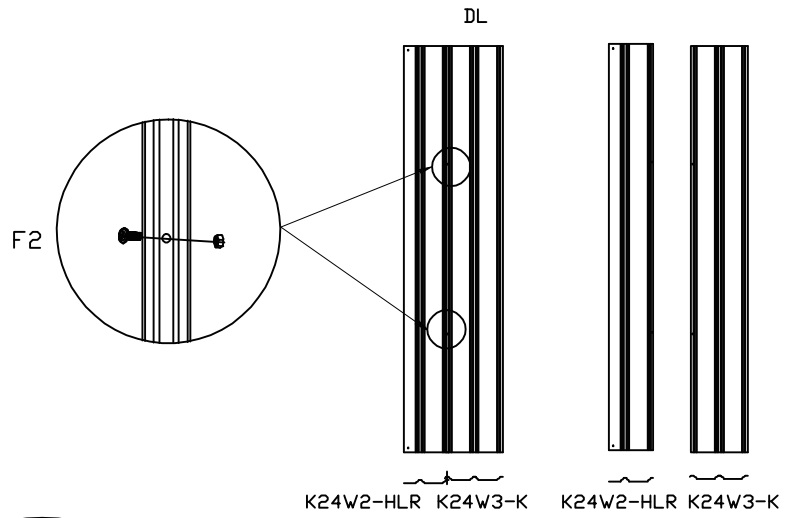

Right door panel splicing

PART	NO.	QTY.
	K24W3-K	1
	K24-W2HLR	1
	K26DLA	1
	K24DA	1
	C13-DDA	2
	F1	4
	F2	2

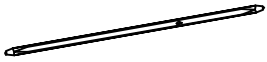



PART	NO.	QTY.
	K24DBA	2
	F1	6
	F2	2

Right door panel splicing

Attention: Installation sequence of screws ① → ② → ③ → ④ → ⑤ → ⑥ → ⑦ → ⑧

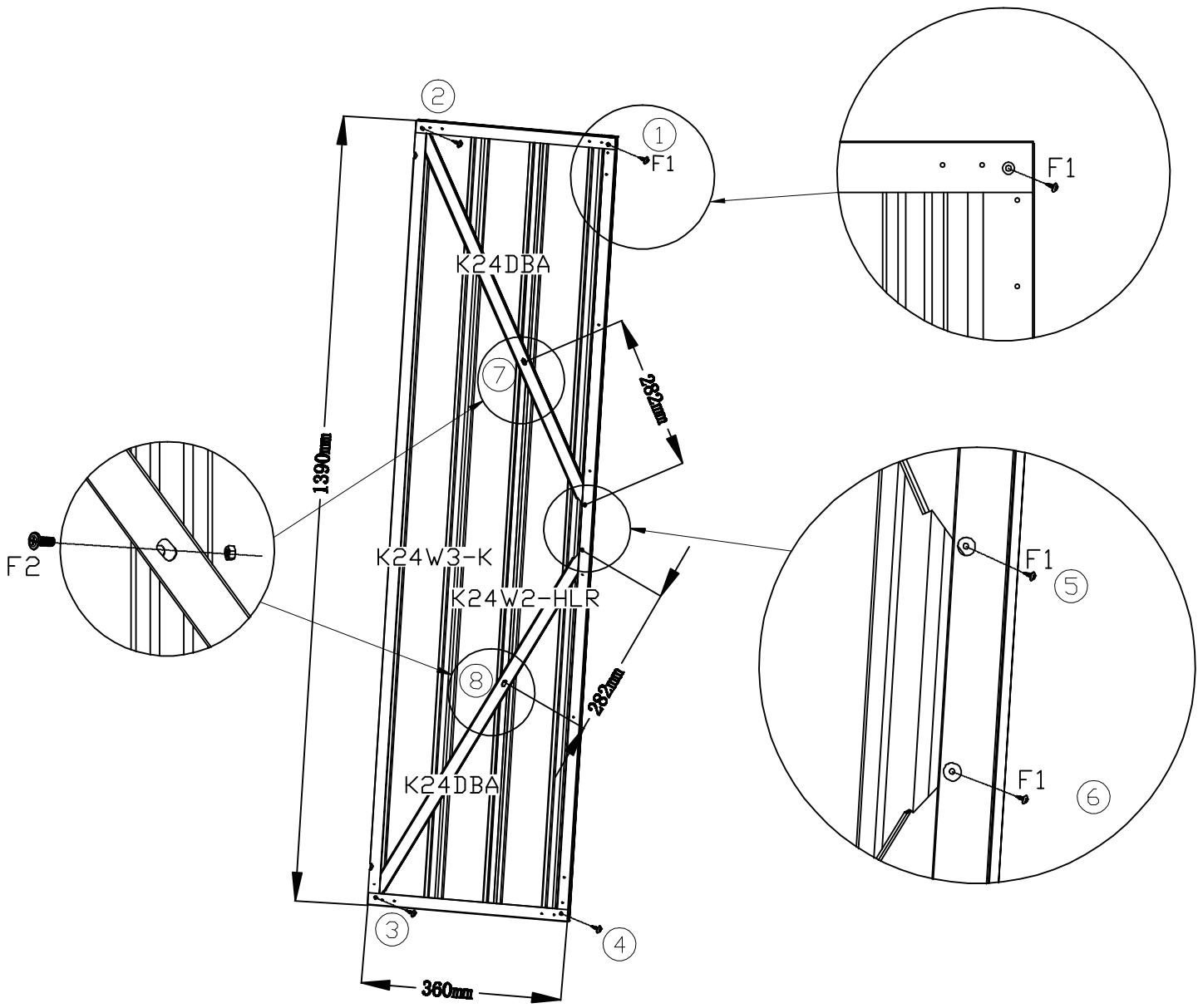
back



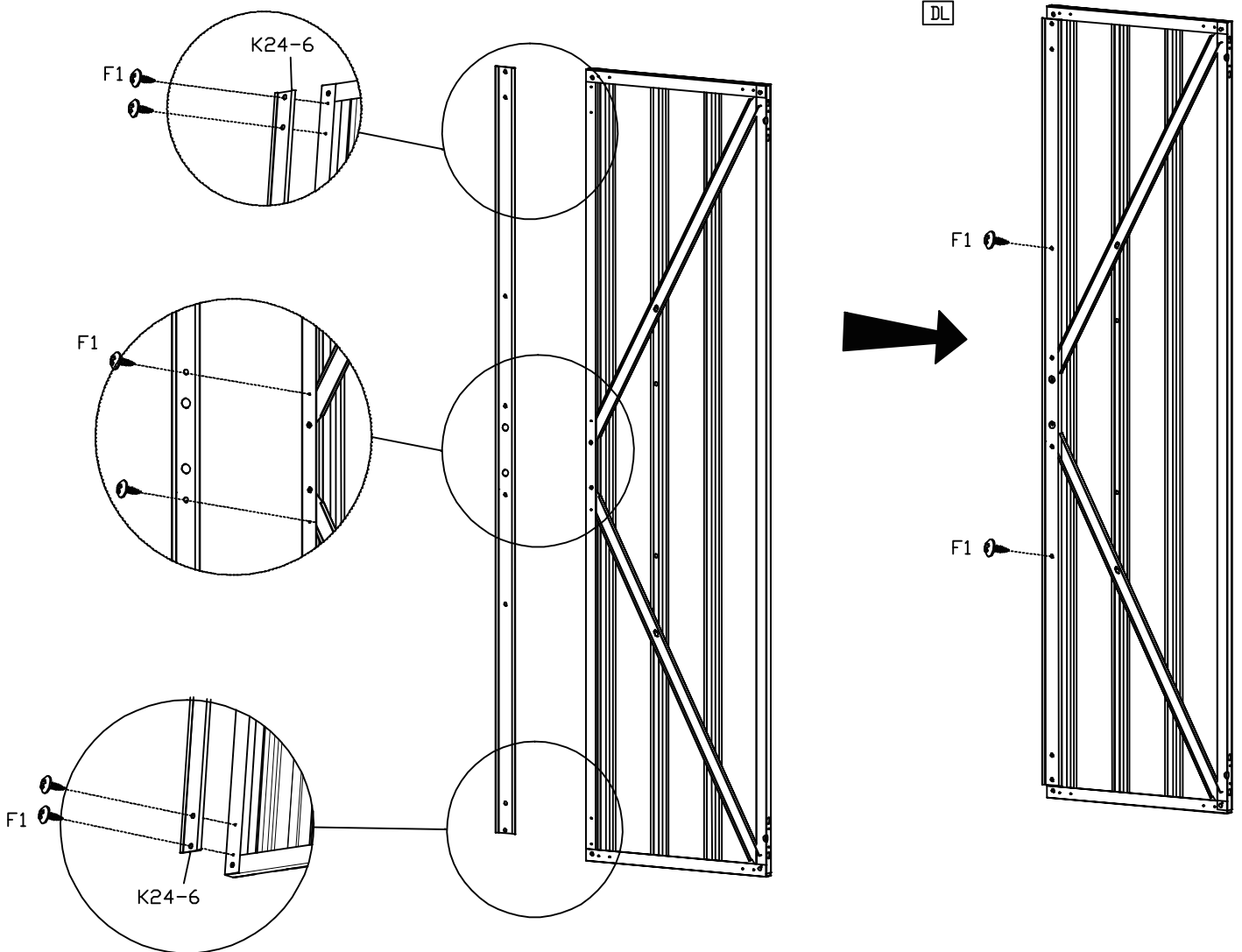

PART	NO.	QTY
	K24-6	1
	F1	8

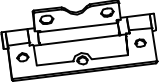
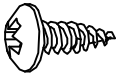

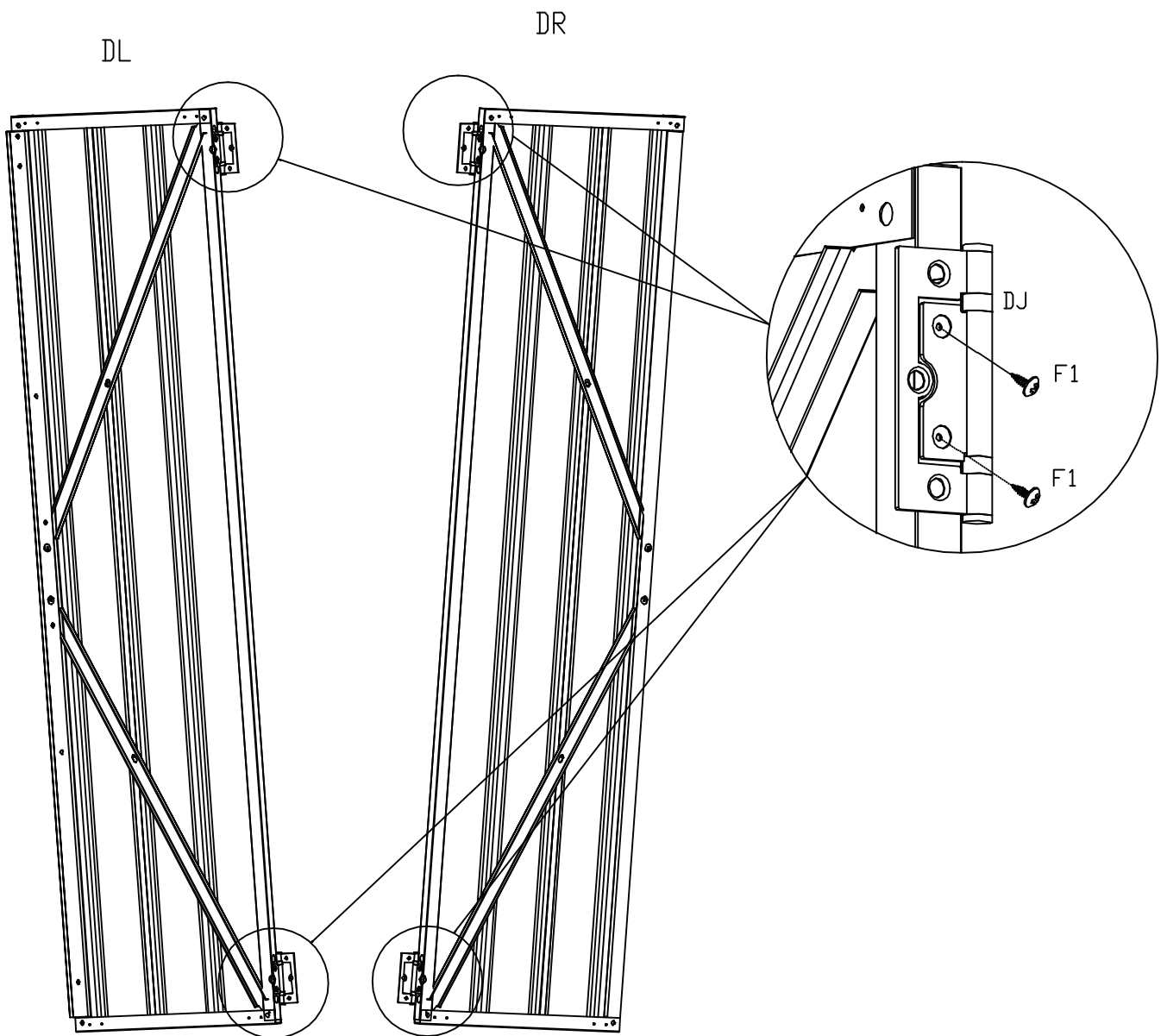

PART	NO.	QTY
	DJ	4
	F1	8

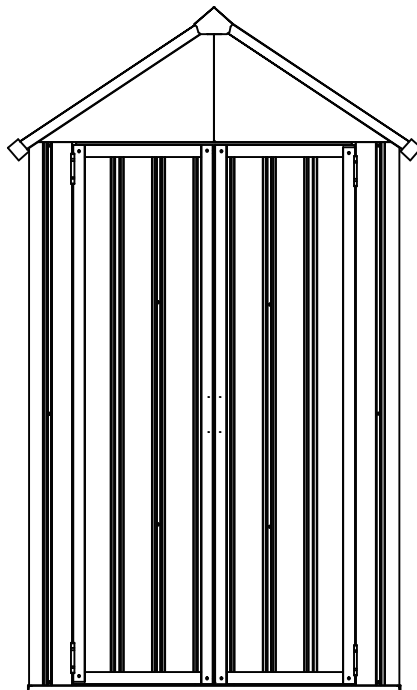
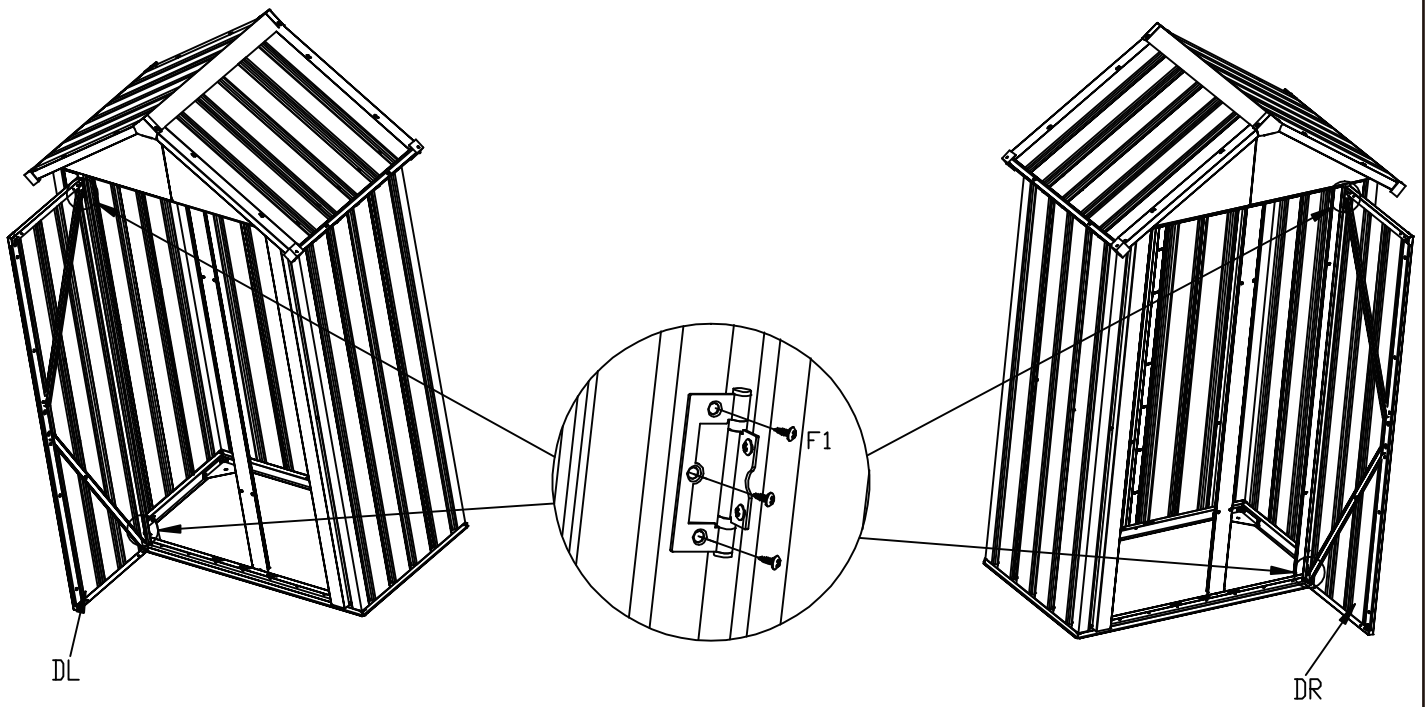

PART	NO.	QTY
	DL	1
	DR	1
	F1	12



PART	NO.	QTY
	CT	8
	F8	8

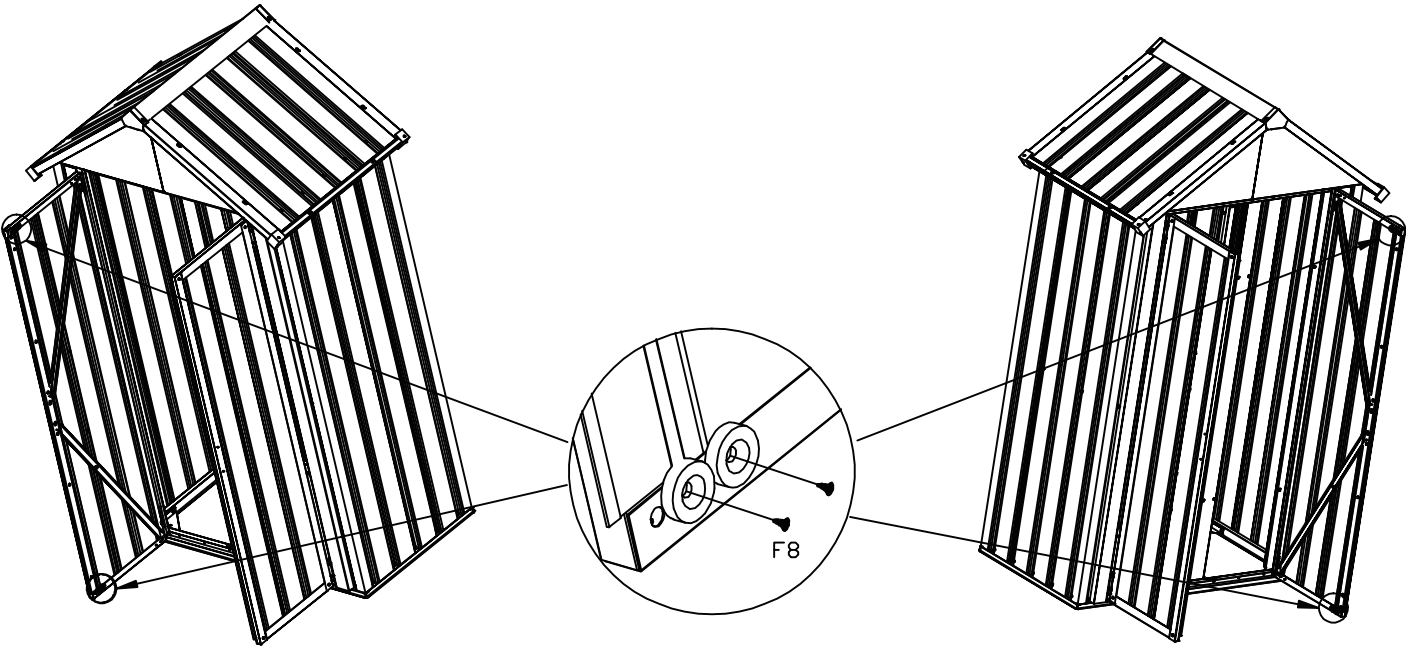

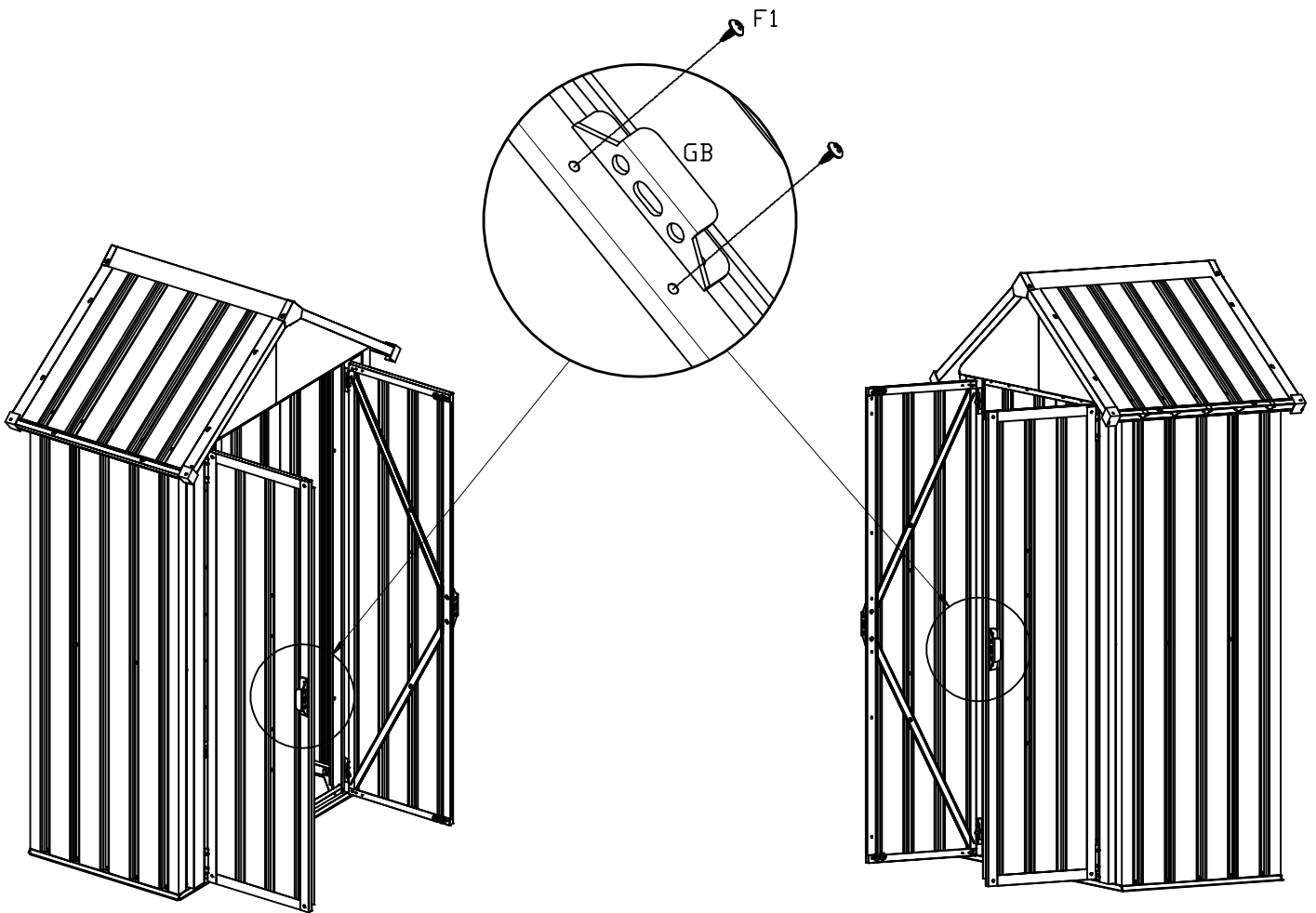

PART	NO.	QTY
	GB	2
	F1	4



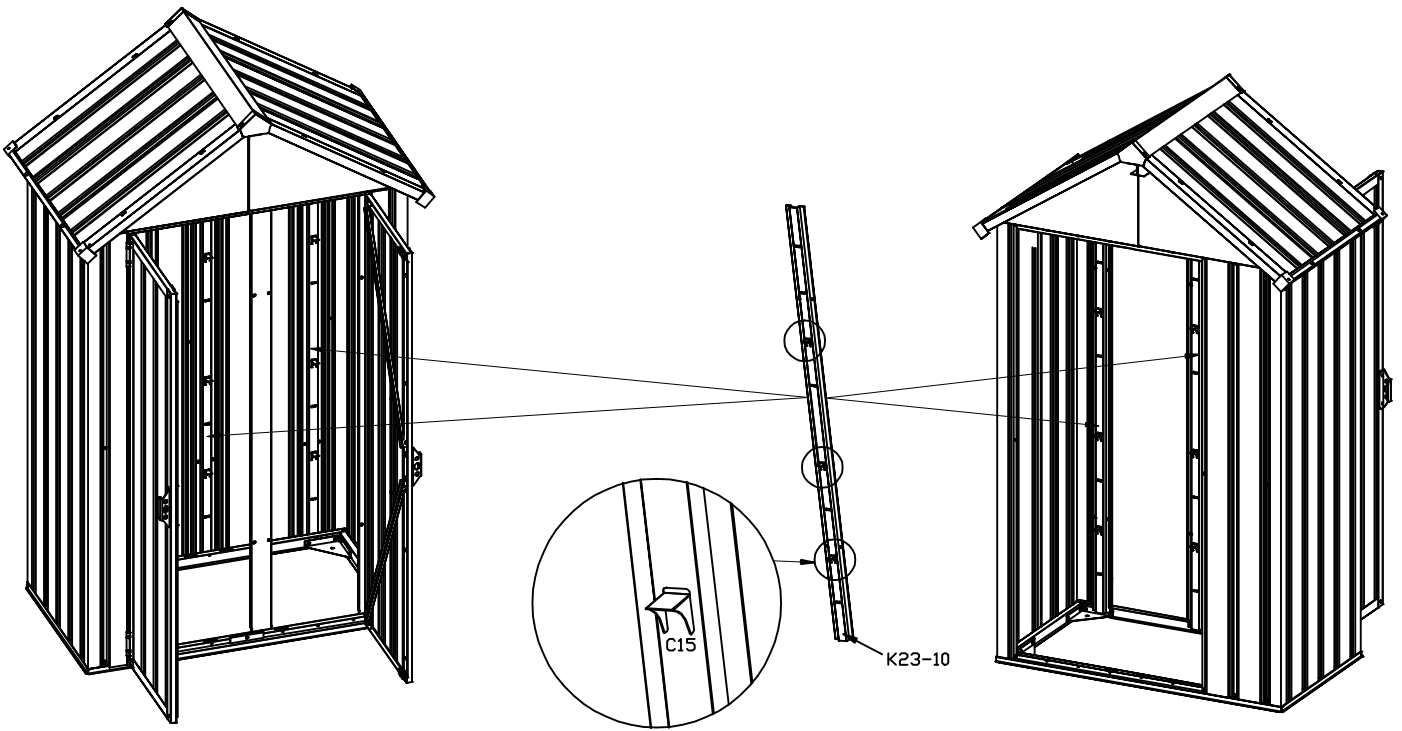



PART	NO.	QTY
	C15	12

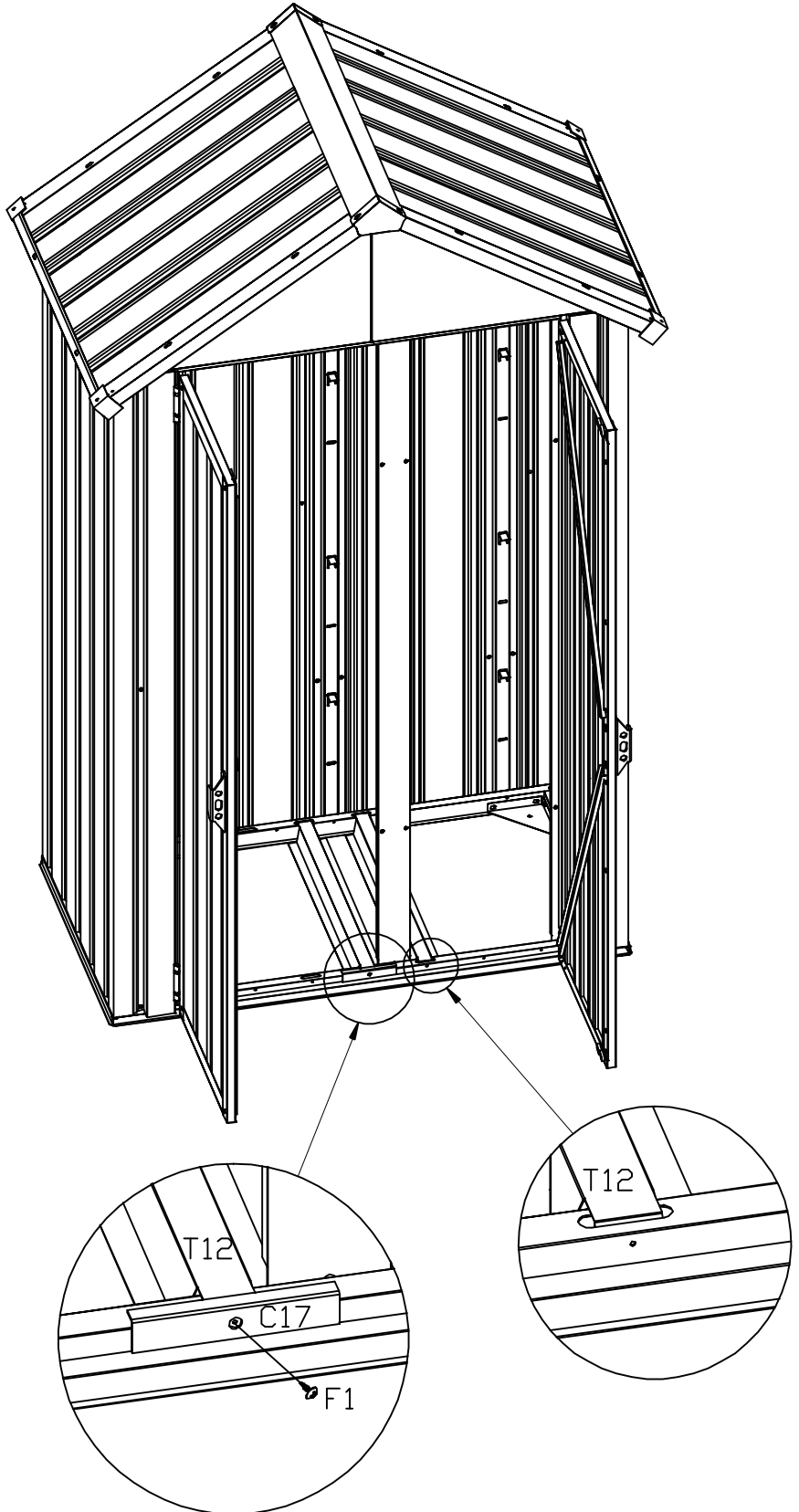

Pendant C15 is hung on holes of equal height in K23-10 to support the storage board.

PART	NO.	QTY
	T12	2
	C17	1
	F1	1





PART	NO.	QTY
	K24-9	2
	K24-10	2
	F1	8

K24-9 component (1 groups)

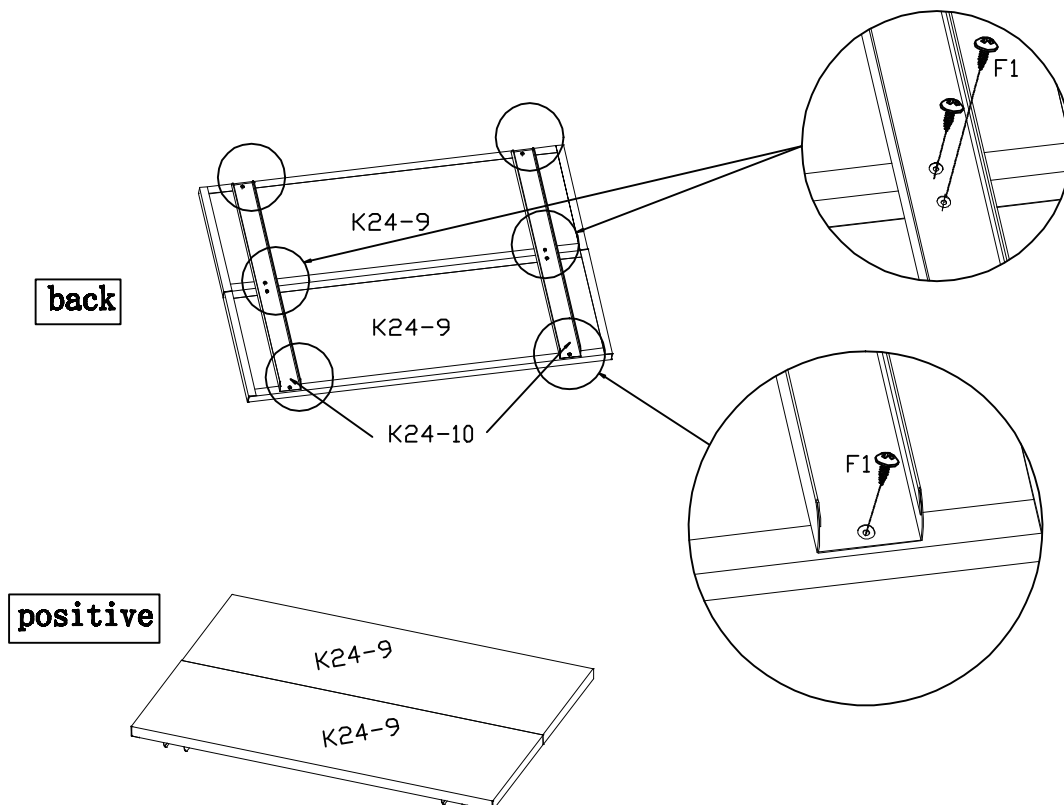
K24-9 and K24-10 are combined and connected with F1 self tapping screws as storage boards in the box.



PART	NO.	QTY
	K24-8	8
	K24-10	8
	F1	32

K24-8 component (4 groups)

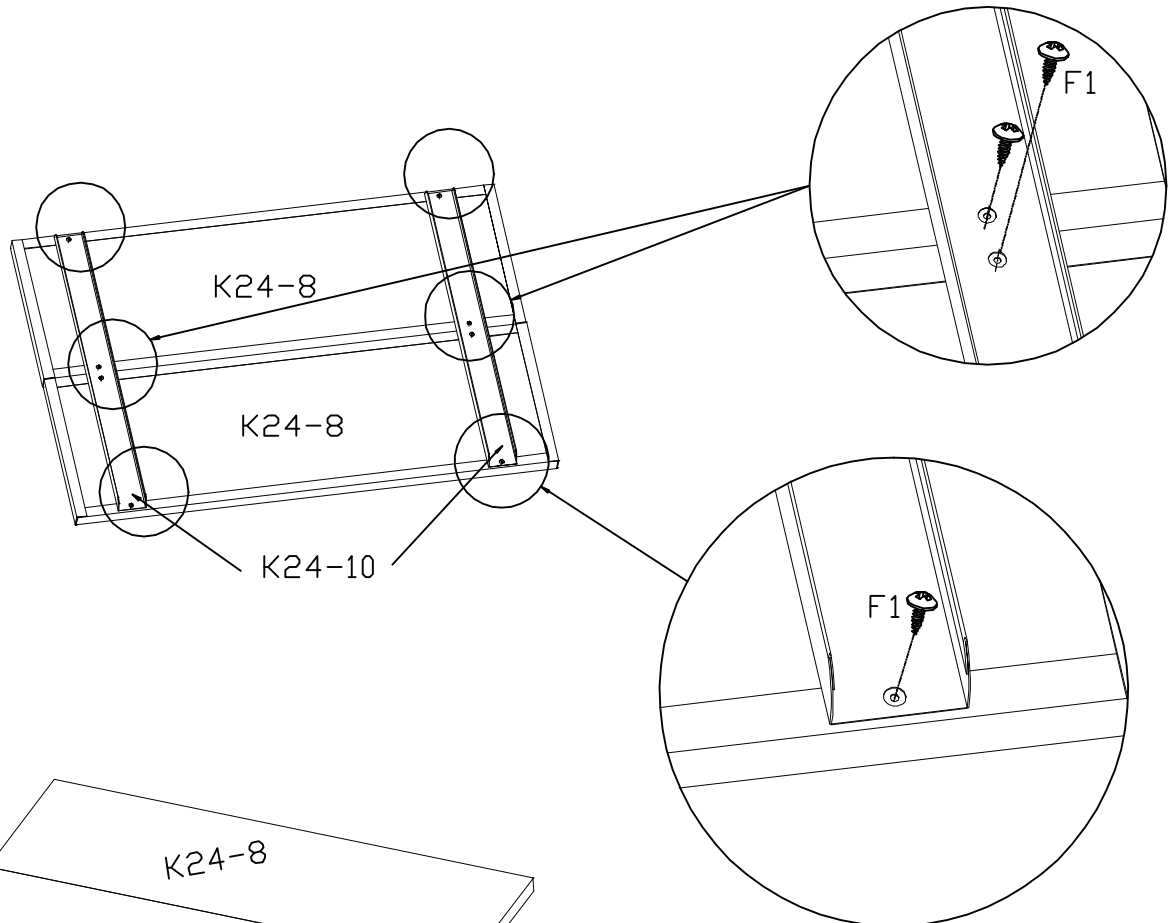

K24-9 and K24-10 are combined and connected with F1 self tapping screws as storage boards in the box.

back

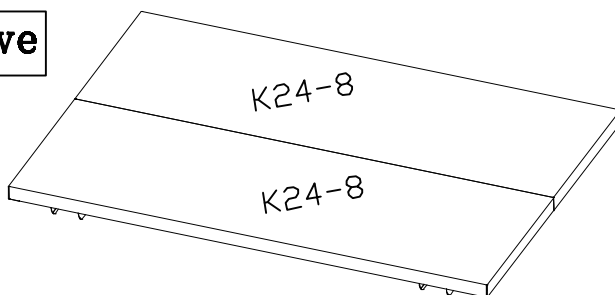

positive



PART	NO.	QTY
	K24-8 component	4
	K24-9 component	1

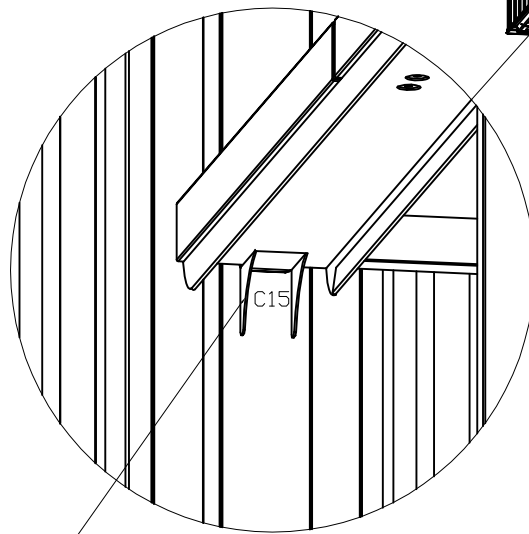
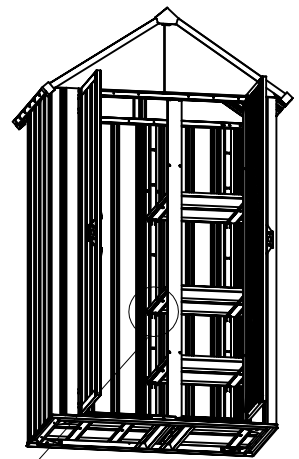
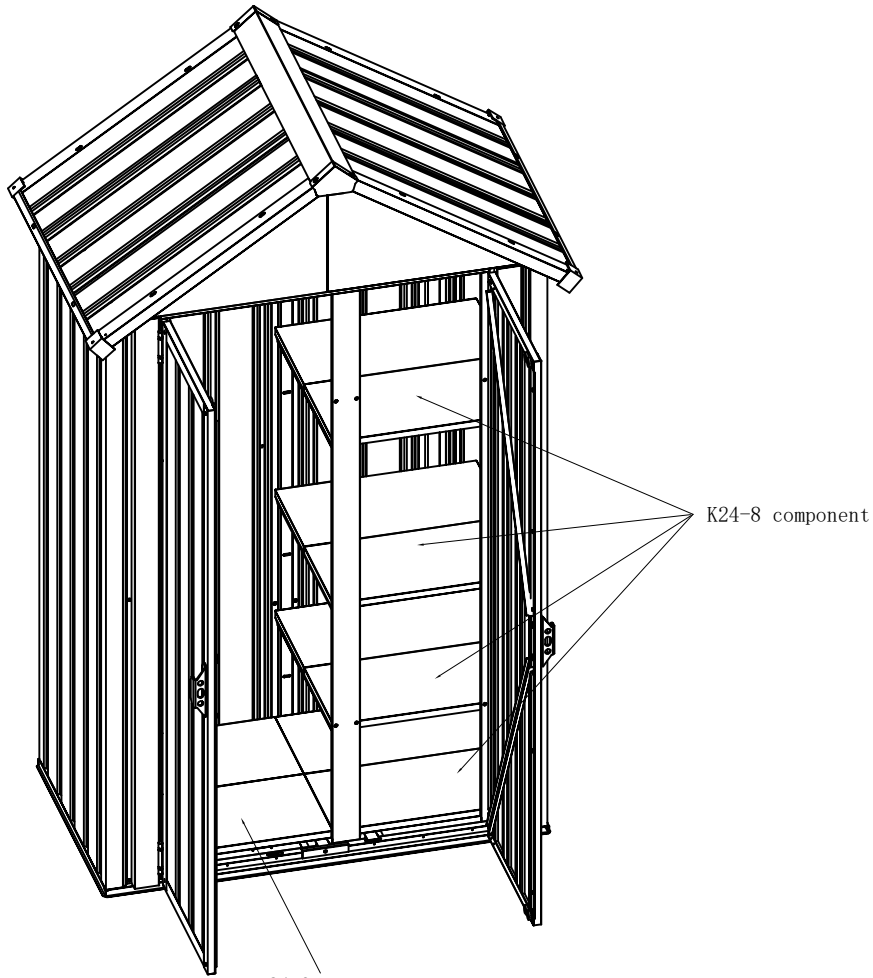

Place the K24-8 component on C15 at the same height.

PART	NO.	QTY
	SL	6

