

## WARNING

- \*\* WE RECOMMEND INSTALLATION OF THIS LIGHTING FIXTURE BE DONE BY A LICENSED ELECTRICIAN \*\*
- \* Switch off the main electrical supply from the main fuse box / circuit.
- \* Breaker before installation.
- \* Inspect item carefully before attempting to install.
- \* If there is any damages or obvious defects, do not install.
- \* Item may not be returned once it has been installed.

## CARE AND MAINTENANCE







- \* To clean the outside of the fixture, use a dry or slightly dampened clean cloth (use clean water, never a solvent) to wipe the surface of the fixture.
- \* To clean the inside of the fixture, first disconnect power to the fixture by turning off the circuit breaker or by removing the fuse at the fuse box. Next, use a dry or slightly dampened clean cloth (use clean water, never a solvent) to wipe the interior surface of the fixture.
- \* Do not use any cleaners with chemical, solvents or harsh abrasives. Use only a dry soft cloth to dust or wipe carefully.

## NOTICE& IMPORTANT SAFETY INSTRUCTIONS

- \* Please make sure that you have all parts indicated before you begin assembly of this item
- \* This item should be assembled on a soft surface to prevent scratching the finish during assembly
- \* To reduce the risk of fire, electrical shock or injury to persons or property, please follow the guideline below for safe use and installation
- \*The external flexible cable or cord of this lamp cannot be replaced  
If the cord is damaged, the lamp shall be destroyed

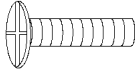
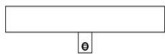
**Product Dimensions: 9.75"Lx9.75"Wx19-78"H**

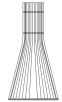
## Part List and Hardware List

PIECE	DESCRIPTION	PICTURE	QUANTITY	PIECE	DESCRIPTION	PICTURE	QUANTITY
A	Wire Nut		3X	E	Bulb		1X
B	Mounting Screw		2X	F	Canopy		1X
C	Mounting Plate		1X	G	Shade		1X
D	Canopy Screw		2X	H	Allen screw		1X

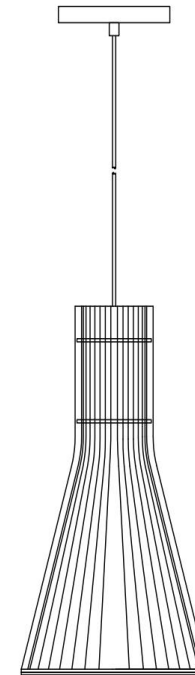

## PREPARATION

- \* Before beginning assembly of product, make sure all parts are present. Compare parts with package contents list and hardware contents list.
- \* If any part is missing or damaged, do not attempt to assemble the product.
- \* Estimated Assembly Time: 30 minutes.
- \* If you are having difficulty, our friendly Customer Care team is always here to help. Please email [customersupport@safavieh.com](mailto:customersupport@safavieh.com)

**NOTE: PLEASE USE TYPE "A" BULB MAX 60-WATT OR LED BULB MAX 9-WATT, THERE IS 1PC LED 4-WATT BULBS IN THE BOX**

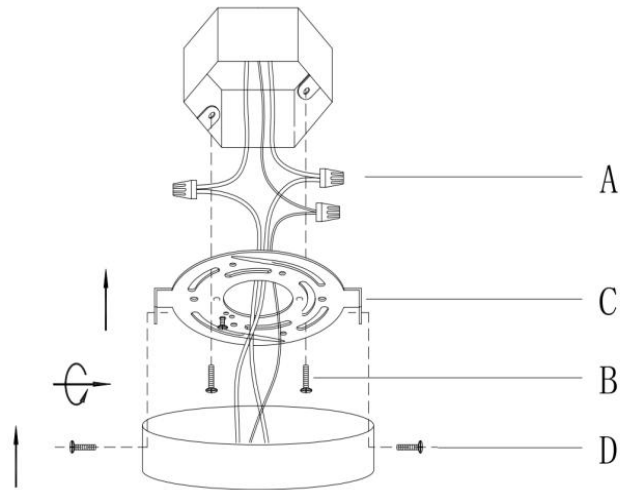

Step 1: Unpack all parts from cartons carefully.  
Separate the Mounting Plate(C) from the Canopy (F) by removing the Canopy Screw(D) anti-clockwise.

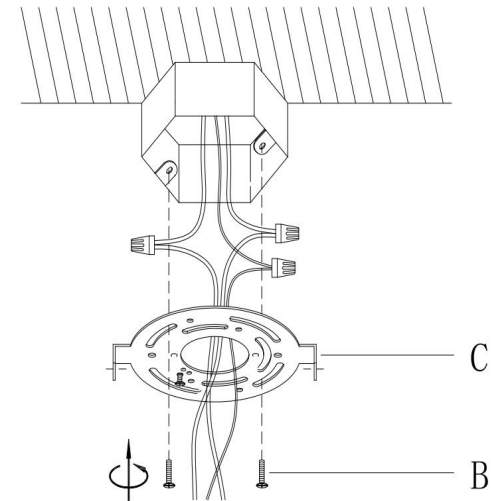

Step 2: Attach the Mounting Plate (C) onto the junction box and fix it by inserting the Mounting Screws(B) clockwise till tight.

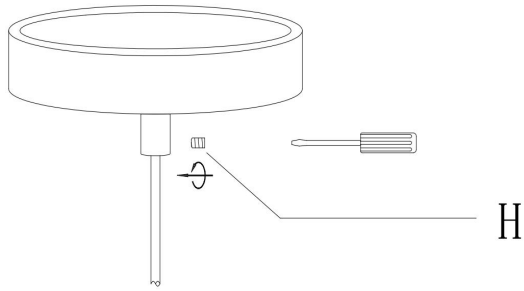

Step 3: If the length of the power cord is unavailable to you, pls unscrew the Allen screw(H) with Allen wrench anti-clockwise, adjust the cord through the Canopy of the Lamp Body to your desired length, then fix it by turning the Allen screw(H) with Allen wrench clockwise till tight.

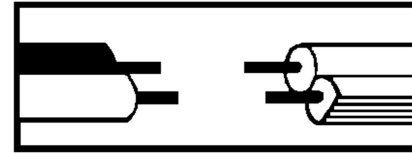

**Step 4: Wire connection**

Connect fixture neutral wire (ribbed) to the outlet box neutral wire (usually white) using a wire nut(A).

Connect fixture hot wire (smooth with markings) to the outlet box hot wire (usually black) using a wire nut(A).

**CAUTION:** Do not reverse the hot and neutral connections

**Grounding Instructions:**

Wrap ground wire from outlet box around green ground screw(B) on mounting bracket, no less than 2" from wire end. Tighten ground screw. If fixture is supplied with a ground wire, connect to outlet ground wire with a wire nut(A).

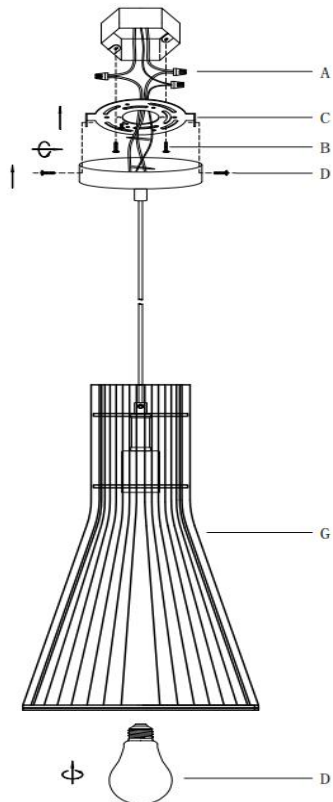

Step 5: Attach the Canopy of the Lamp Body over the Mounting Plate (C) and fix it by turning the Canopy Screw(D) clockwise till tight. Insert the bulb(E) into the socket of the Lamp Body until secure. **DO NOT EXCEED THE SPECIFIED WATTAGE.**