

Narzędzia potrzebne do montażu

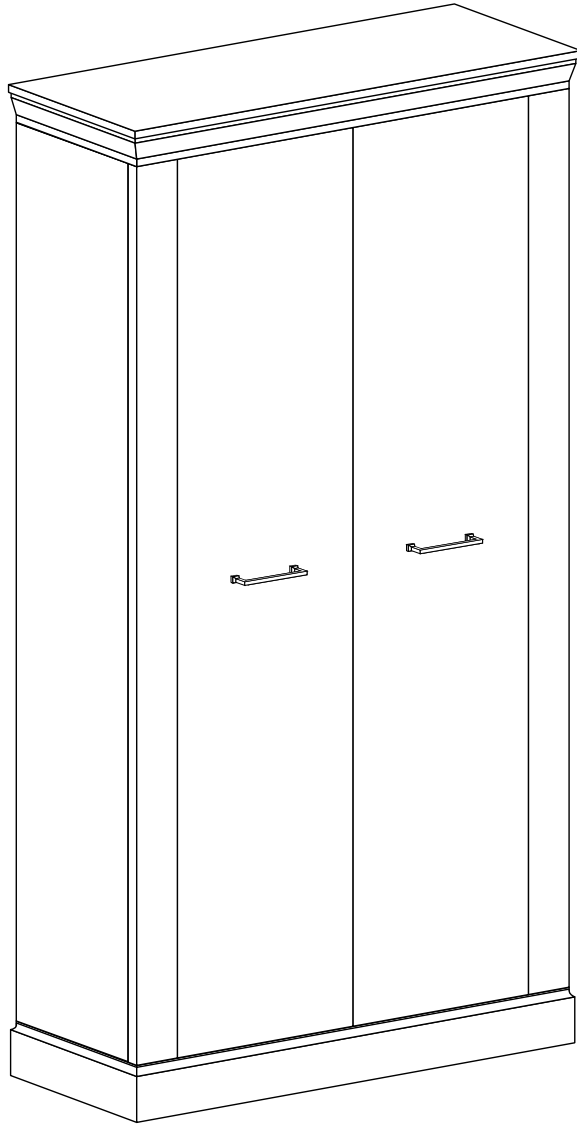
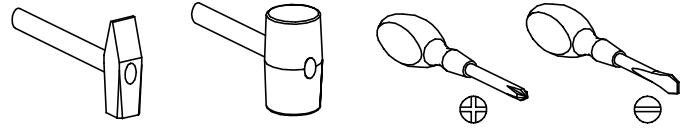

Nr	Nazwa elementu	D[mm]	S[mm]	G[mm]	Ilość
1	Bok P/L	1865	540	16	2
2	Błat Górny	1070	580	71	1
3	Błat Dolny	1040	572	100	1
4	Wieniec	978	525	16	2
5	Listwa	978	120	16	1
6	Listwa P/L	1862	100	32	2
7	Listwa Maskująca	810	55	16	2
8	Kapak	1892	499	2,5	2
9	Drzwi P/L	1800	400	16	2

UWAGA !!!

MONTOWANIE USZKODZONYCH
ELEMENTÓW POWODUJE UTRATĘ
GWARANCJI

W przypadku reklamacji proszę podać numer pakowacza znajdujący się na kartonie.

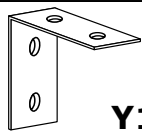

Y1 - 2 St.

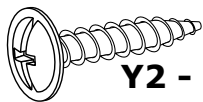

Y2 - 4 St.
3,5x16 mm

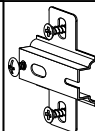

W1 - 6 St.

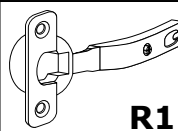

R1 - 6 St.



X1 - 34 St.



S - 3 St.
3,9x30 mm

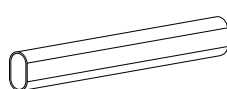

P - 1 St.

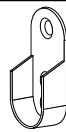

F - 2 St.

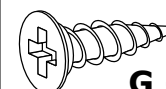

G - 26 St.
3,5x16 mm



Ł - 1 St.



E - 65 St.

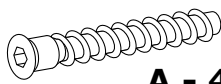

A - 4 St.
7x50 mm

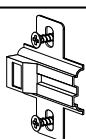

W2 - 2 St.

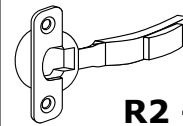

R2 - 2 St.

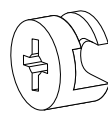

L - 34 St.

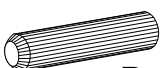

B - 24 St.
8x35 mm

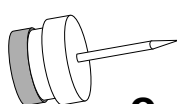

Q - 4 St.

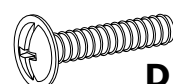

D - 4 St.
4x25 mm



U - 2 St.

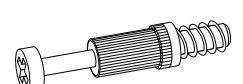

K - 34 St.

I

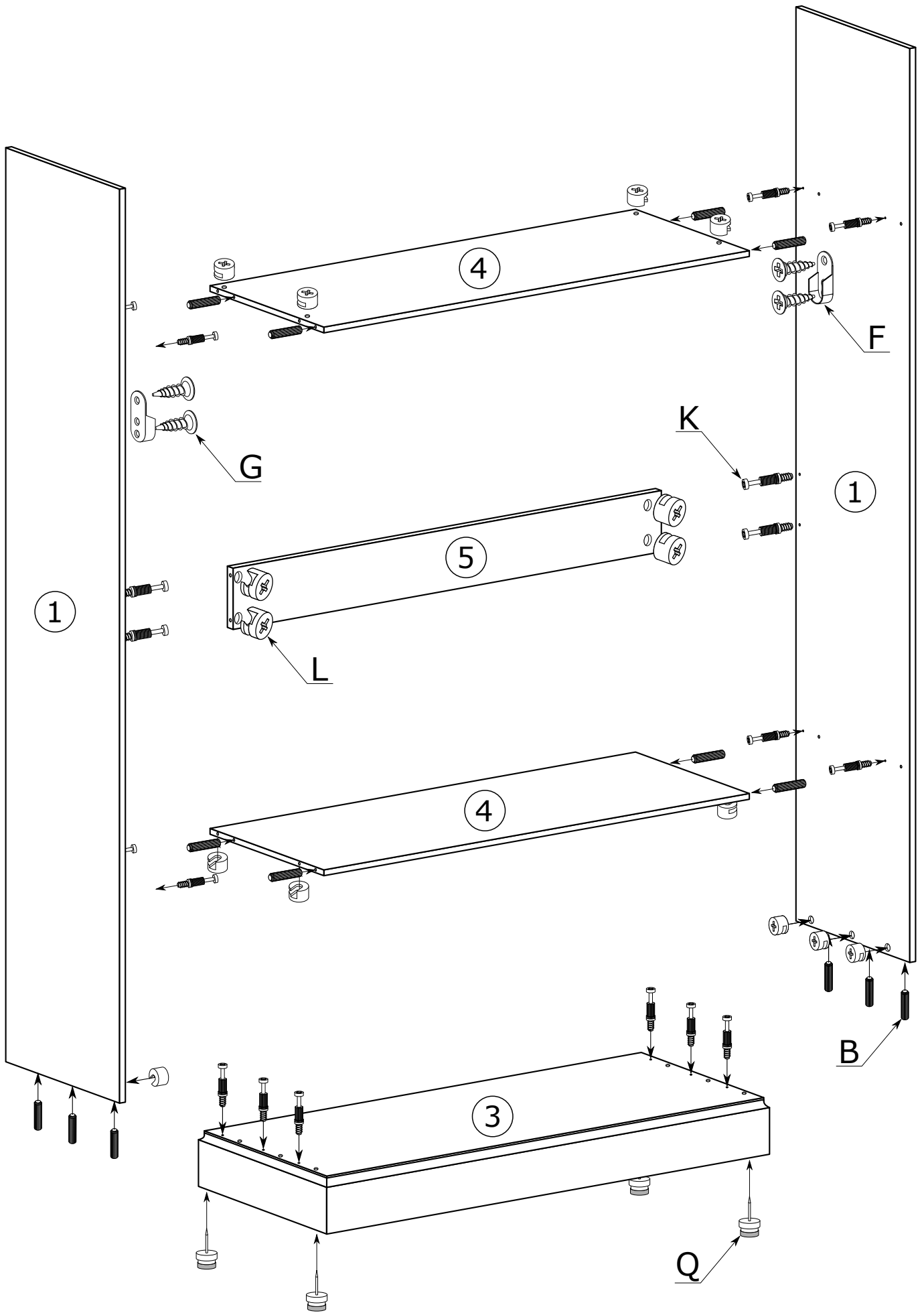

II

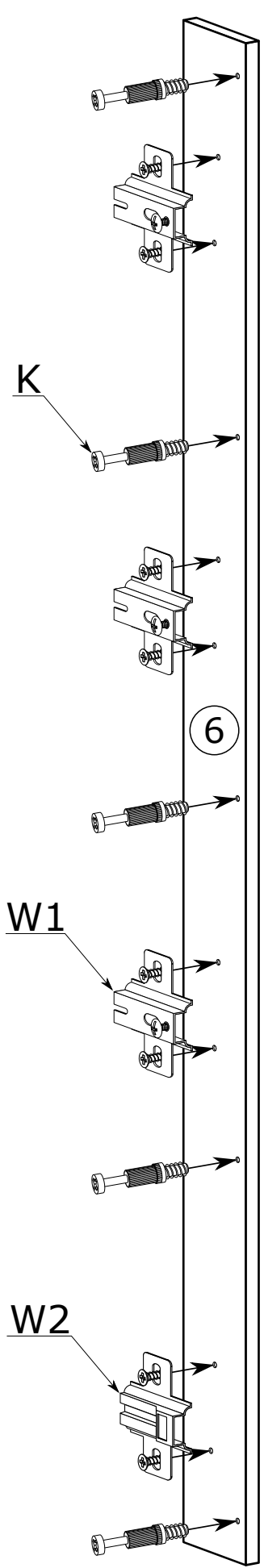
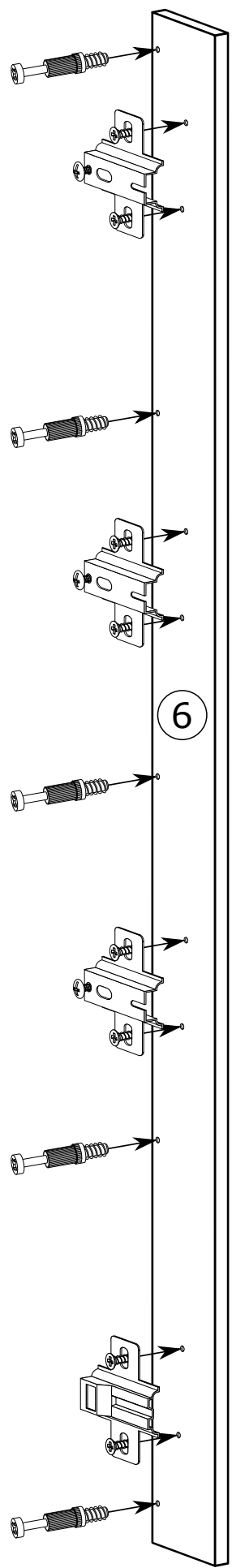

III

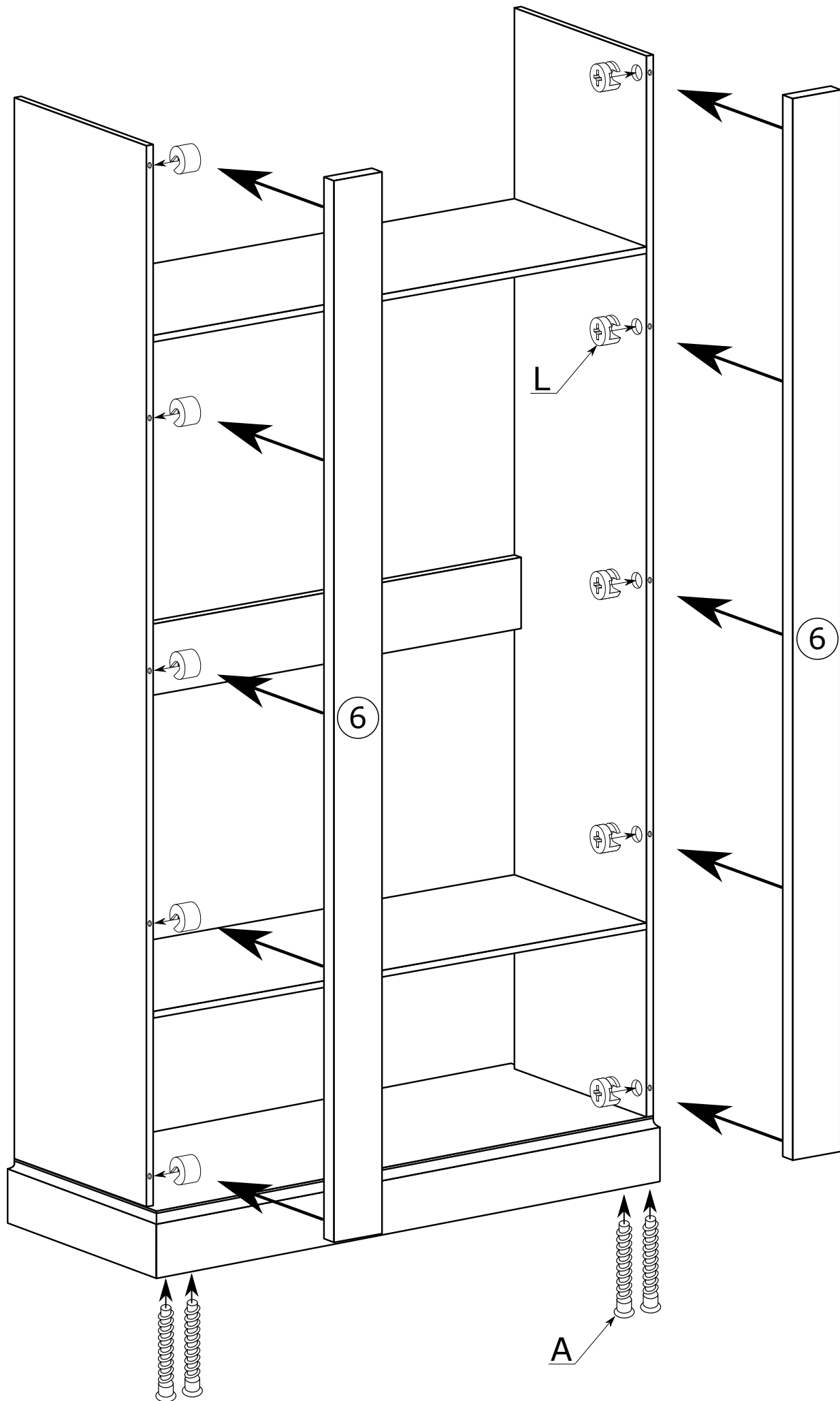

IV

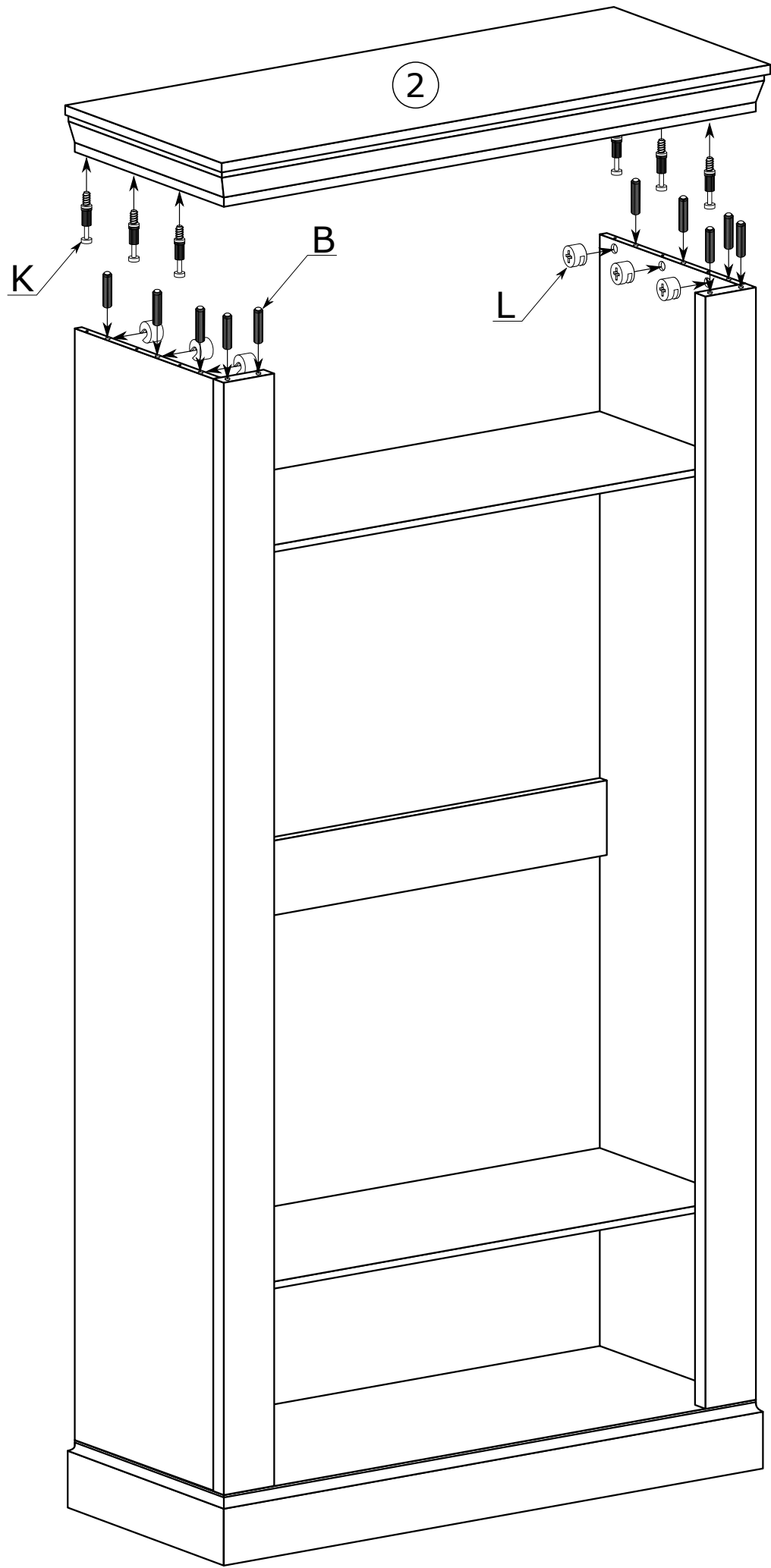

V

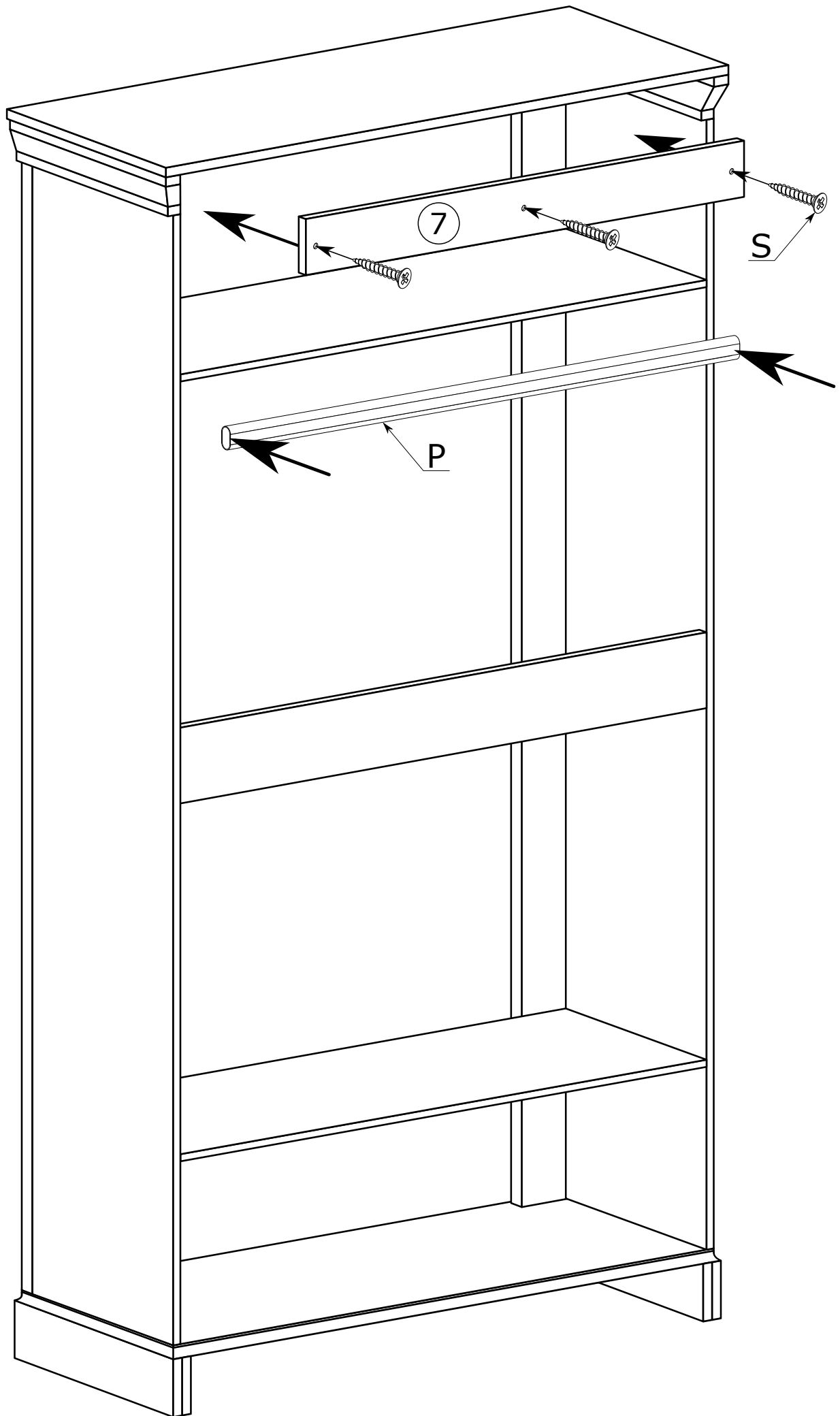

VI

x65

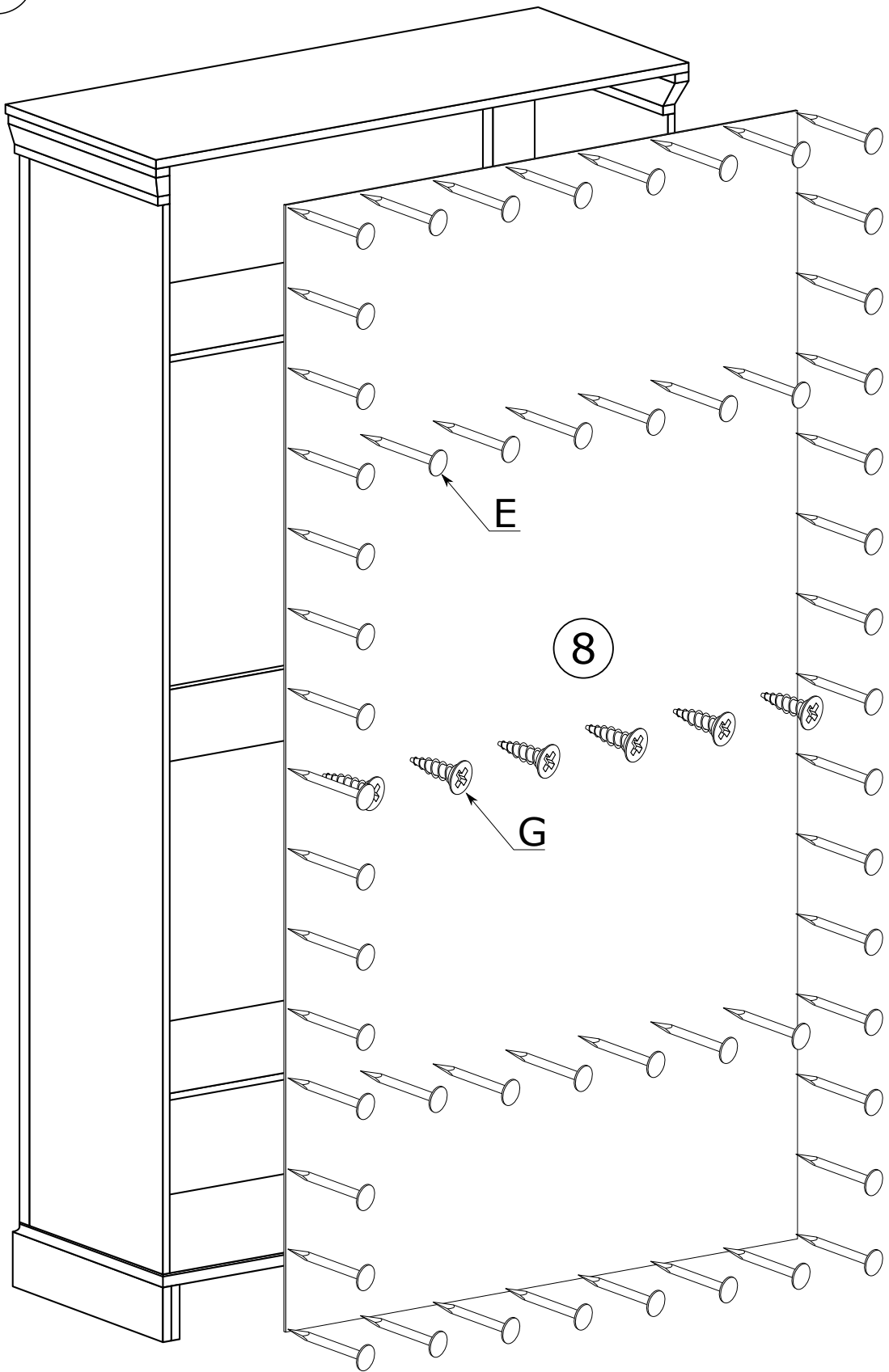
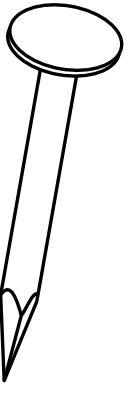

<p>A = B</p>		

VII

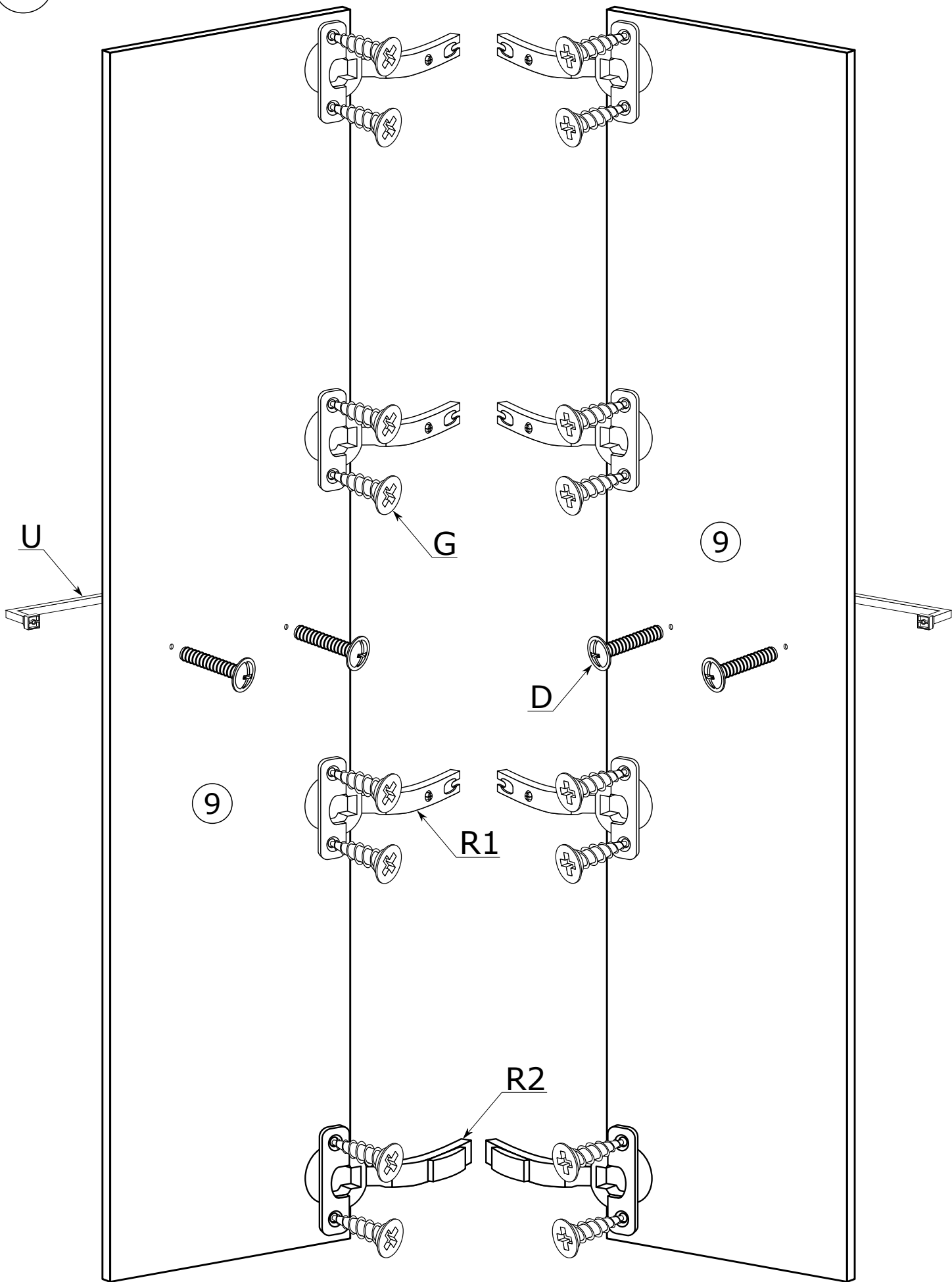

VIII

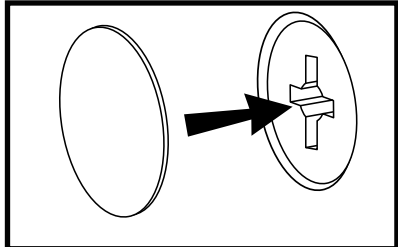
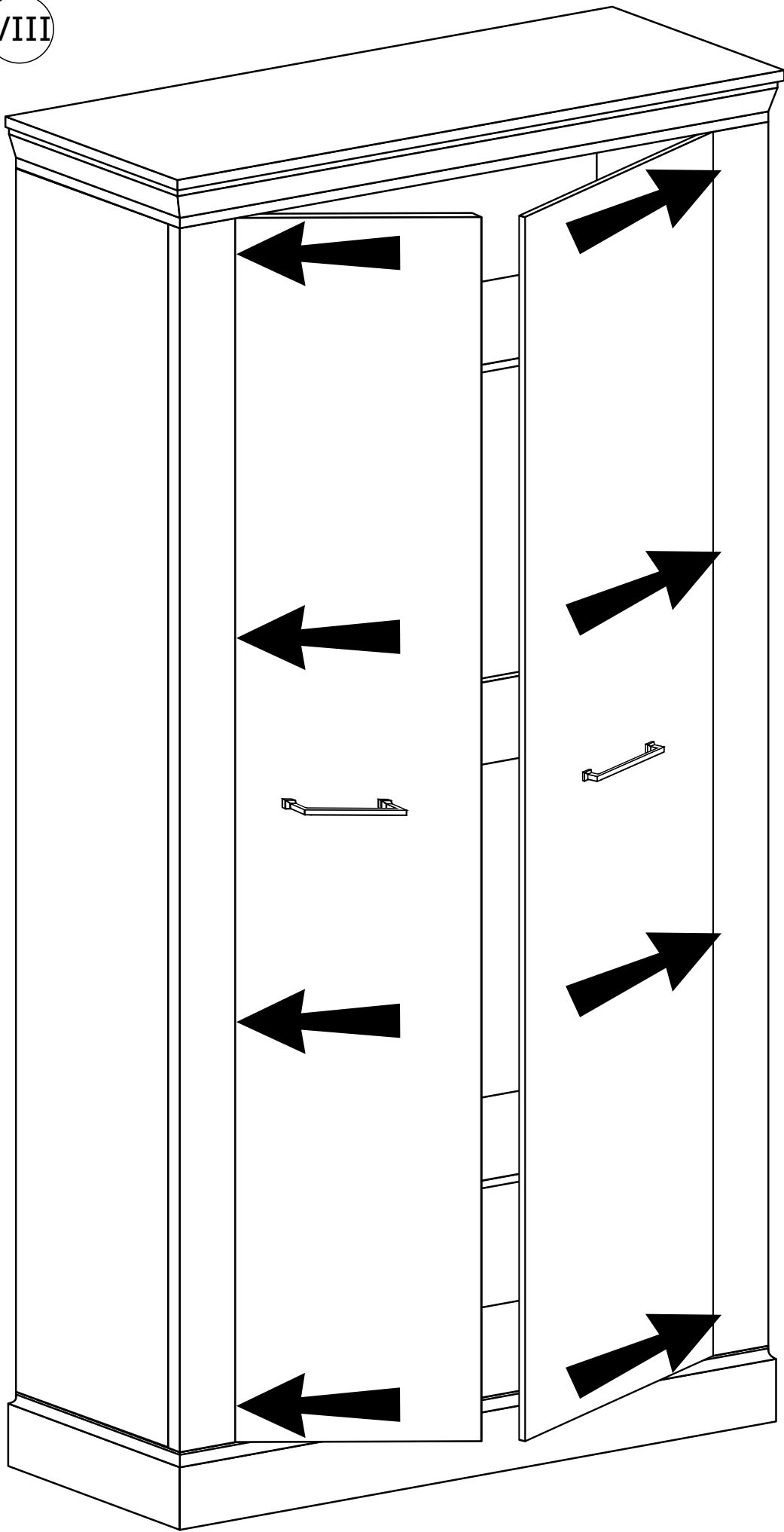

A

