

Pet Stroller

ASSEMBLY INSTRUCTION



ADULT ASSEMBLY REQUIRED

Read all instructions before assembly and use.
Due to the presence of small parts during assembly, keep
out of reach of children until assembly is complete.

BP-S04T

BP-S8013L



FDW
BEST QUALITY. LOWEST PRICE. GUARANTEED

www.paylesshere.com

PARTS LIST



Pet stroller
1PC

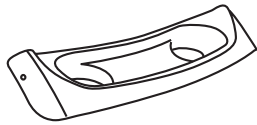

Teacup tray
1PC

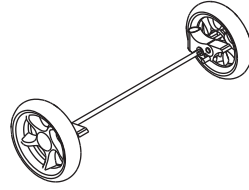

Rear wheels
1PC



front wheel
2PCS

Assemble 1

Please fasten the basket to the iron frame.

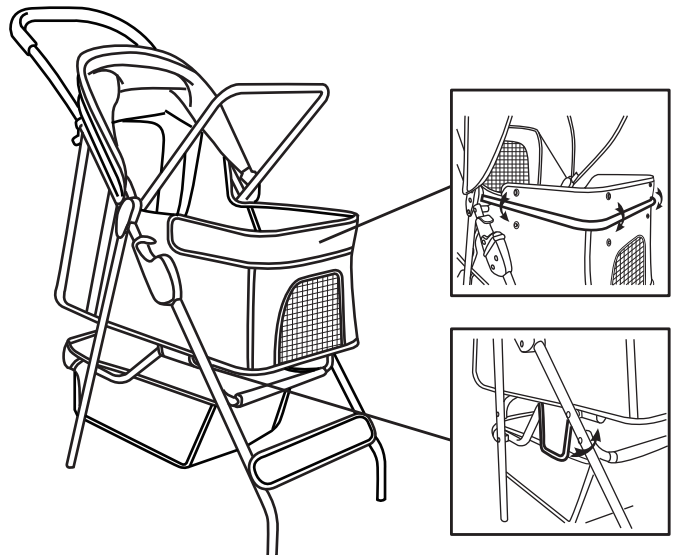
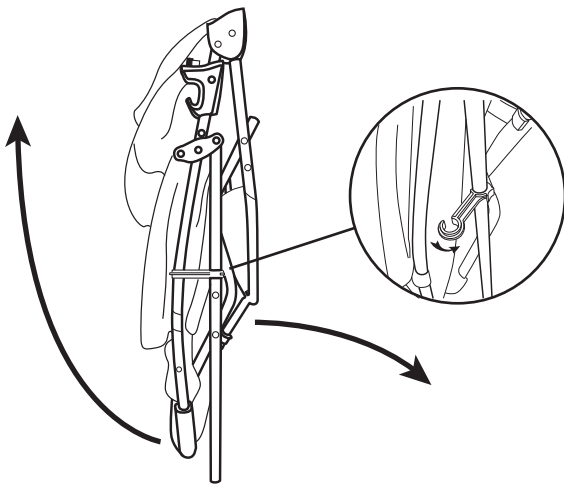

Assemble 2

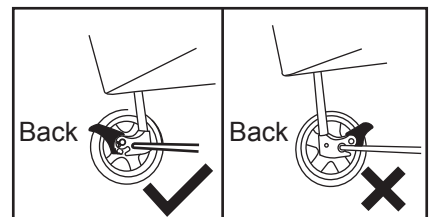
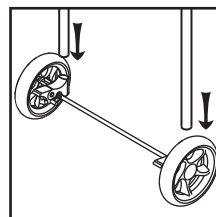
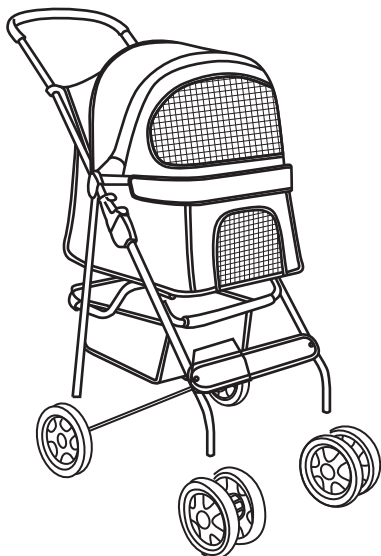

Now attach the rear wheels on the rear legs and hear the "click" to secure.
Pay attention to the direction of installation

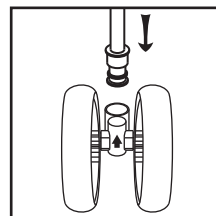

To install the front wheel, insert wheel onto the leg until a "click" is heard.
Pay attention to "↑" label and follow instruction.

Assemble 3



Install Cup holder

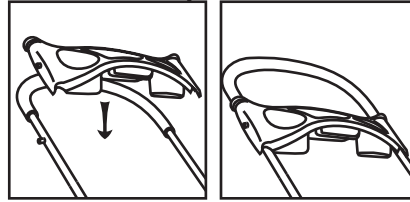

Aim the hole of the cup holder to the plastic nuts on both sides of handle tube and install it.

Disassembly 1

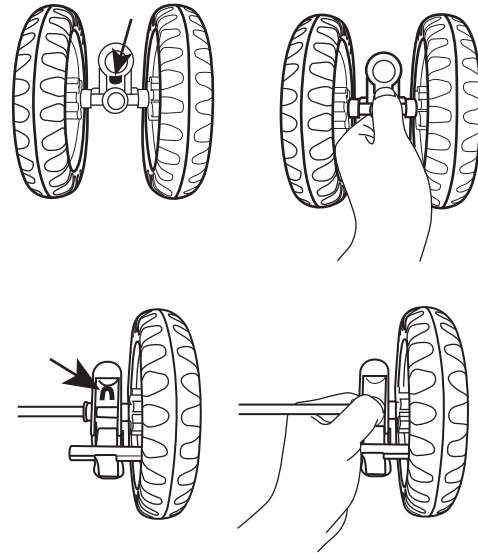
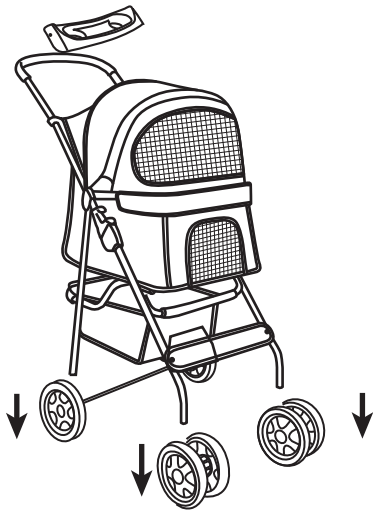

Disassembly 2

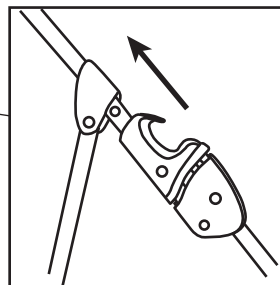
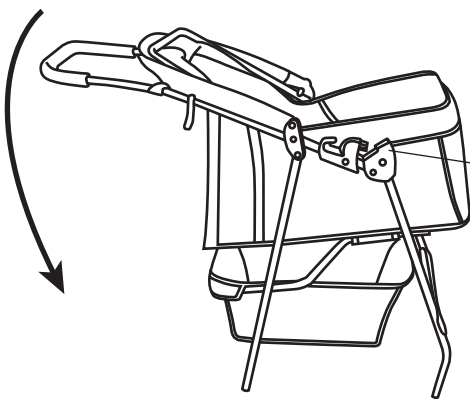

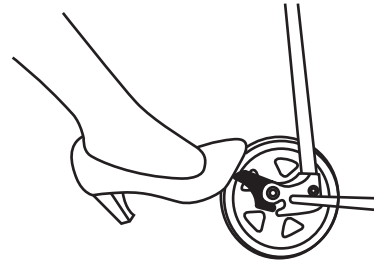

For your pet's safety, always apply the brakes when the pet stroller is stationary.

Lock the rear wheels by simply pushing down the brake levers on either side.

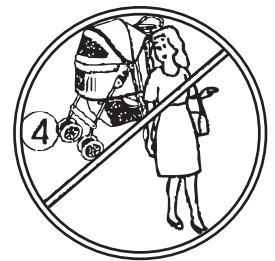
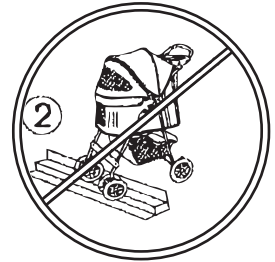
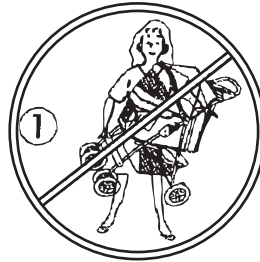

WARNING

1. Do not lift up the stroller when the pet is in.
2. Never use the stroller on uneven place.
3. Never use the stroller near the fire or other dangerous area.
4. Must use brakes when you stop moving you stroller.
5. Do not put two or more than two pets in one stroller.
6. Do not store or use this stroller in areas exposed to high or low temperature or humidity for a long time.
7. Maximum pet weight for this strollers is 15kgs.