

Freestanding Storage Cabinet / Armoire de rangement autoportante

Please keep for future reference
s' il vous plaît garder pour référence future

SKU : N717P399852

SKU : N717P399853

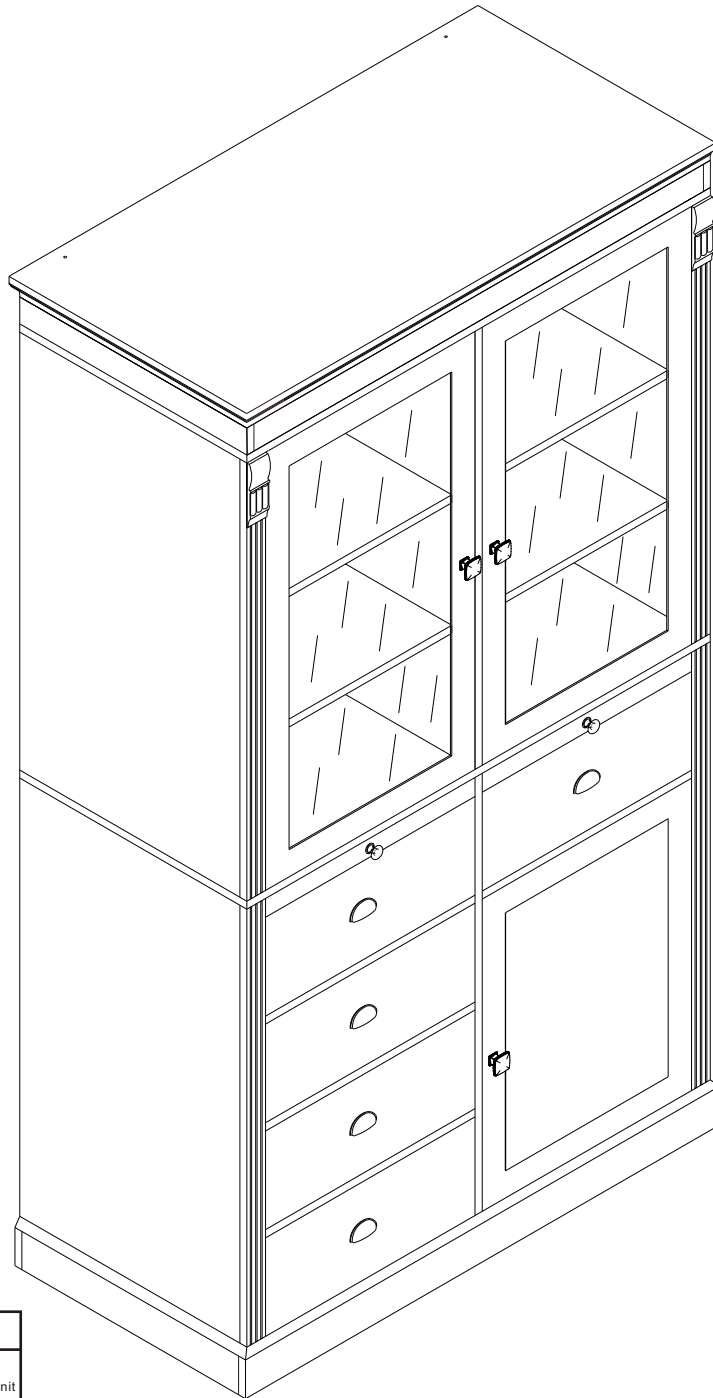

	WARNING
	This product is NOT a Clothing Storage Unit (CSU). DO NOT use it for clothing storage. Improper use may cause furniture tipover.

Important - Please read these instructions fully before starting assembly
Important - veuillez lire ces instructions complètement avant de commencer l' assemblage



Safety and Care Advice

Important – Please read these instructions fully before starting assembly

- Check you have all the components and tools listed on the following pages.
- Remove all fittings from the plastic bags and separate them into their groups.
- Keep children and animals away from the work area, small parts could choke if swallowed.
- Make sure you have enough space to layout the parts before starting.

- During assembly do not stand or put weight on the product, this could cause damage.
- Assemble the item as close to its final position (in the same room) as possible.
- Assemble on a soft level surface to avoid damaging the unit or your floor.
- Parts of the assembly will be easier with 2 people.



- To reduce the likelihood of damaging your product please ensure that your power drill is set on a low torque setting.

Care and maintenance

- Only clean using a damp cloth and mild detergent, do not use bleach or abrasive cleaners.
- From time to time check that there are no loose screws on this unit.
- This product should not be discarded with household waste. Take to your local authority waste disposal centre.

Handy Hints

- Assemble all parts and bolts loosely during assembly, only once the product is complete should you fully tighten the bolts
- Regularly check and ensure That all bolts and fittings are tightend properly.

WARNING In order to help prevent overturning – please follow these instructions

To help prevent product toppling over please follow the below steps:-

Use the anti tip stap or wall fixing method provided (if applicable)
Do not allow children to climb or hang on the furniture
Do not open more than one drawer at a time
Do not place heavy items in the top drawers
Do not place heavy items on top of the furniture, unless the furniture has been designed for this purpose

Please note that only the anti tip strap is provided.
You will need to provide wall plugs and screws applicable for your wall type

Conseils de sécurité et d'entretien

Important - veuillez lire ces instructions complètement avant de commencer l'assemblage

- Vérifiez que vous avez tous les composants et outils énumérés sur les pages suivantes.

- Retirez tous les accessoires des sacs en plastique et les séparez

- Gardez les enfants et les animaux de compagnie loin de la zone d'installation, qui peut causer l'étouffement si de petites pièces sont avalées.

- Assurez-vous d'avoir suffisamment d'espace pour mettre en page les pièces avant.

- Ne pas se tenir debout ou appliquer le poids à Le produit pendant l'assemblage. Cela peut causer des dommages.

- Assemblez l'élément le plus près possible de sa position finale (dans la salle de sameroom).

- Assemblez sur un niveau doux Surface pour éviter les dommages À l'unité ou à l'étage.

- Il est plus facile pour deux personnes de se réunir Les parties ensemble.

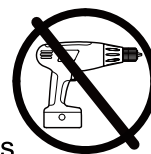

- Pour réduire la probabilité de dommages à votre produit, Assurez-vous que votre perceuse électrique Est réglé sur un réglage de couple faible.

Entretien et entretien

- Nettoyer uniquement à l'aide d'un détergent doux à linge humide, ne pas utiliser d'eau de javel ou de nettoyeurs abrasifs

- Vérifiez les vis desserrées sur Cette unité de temps en temps.

- Ce produit ne doit pas être jeté avec les ordures ménagères emporter au centre d'élimination des déchets de votre collectivité locale

Conseils pratiques

- Assemblez toutes les pièces et boltsloosely pendant l'assemblée, onlyonce que le produit est completeshould vous serrez entièrement les boulons

- Vérifier et assurer régulièrement Que tous les boulons et raccords sont Correctement serré.

Avertissement Afin de prévenir le renversement Veuillez suivre ces instructions

Pour aider à prévenir le renversement du produit, veuillez suivre les étapes suivantes :-

Utilisez la méthode anti-tip stap ou de fixation murale fournie (le cas échéant)
Ne laissez pas les enfants grimper ou accrocher aux meubles
N'ouvrez pas plus d'un tiroir à la fois
Ne placez pas d'objets lourds dans les tiroirs supérieurs
Ne placez pas d'objets lourds sur le dessus des meubles, sauf si les meubles ont été Conçu à cet effet

Veuillez noter que seule la courroie anti-pointe est fournie.

Vous devrez fournir des bouchons muraux et des vis applicables pour votre type de mur

Using Camlocks / Utilisation de Camlocks

Step 1 / Étape 1

Connect the male camlock as directed in the assembly instructions using a screwdriver.

Connecter les hommes
Le verrou à came est endommagé
Écrivez des instructions de montage avec screwdriver.

1 DO NOT OVER TIGHTEN.

Ne pas trop serrer.
NE PAS SERRER EXCESSIVEMENT.

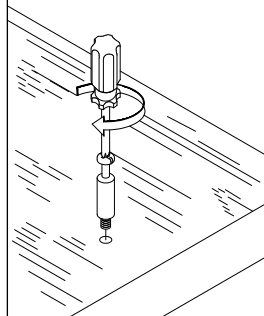

Step 2 / Étape 2

Push the male camlock into the entry hole.

Poussez le verrou à came convexe dans l'orifice d'entrée.

2

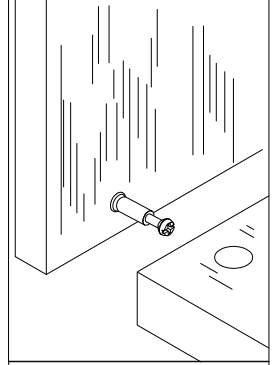

Step 3 / Étape 3

Insert the female camlock as shown in the instruction.
Note: ensure that the arrow on the top of the camlock points towards the entry hole for the male camlock.

Insérer le femle Camlock comme indiqué dans l'Instruction.
Note: assurez-vous que le

3

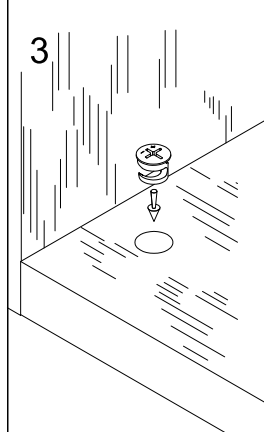

Step 4 / Étape 4

Turn the female camlock clockwise with a screwdriver.
You should feel a click when the camlock is locked in place.
The joint is now secure.

Tournez la femle camlock dans le sens horaire avec un tournevis.
Vous devriez sentir un clic lorsque le camlock est verrouillé en place.
Le joint est maintenant sécurisé.

4

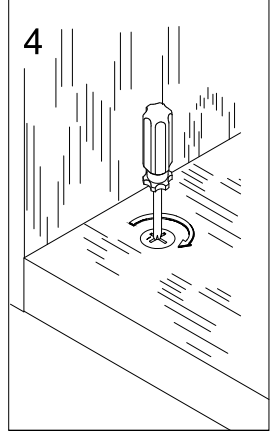

Tools required / Outils nécessaires

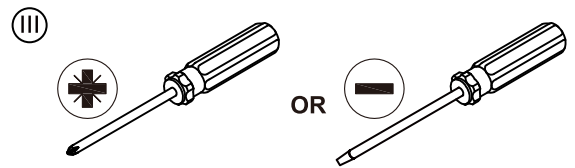
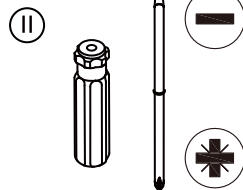
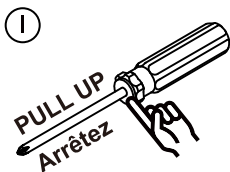

Screwdrivers can be converted to Phillips and Slotted.
Les tournevis peuvent être convertis en Phillips et Slotted.

Ruler - Use this ruler to help correctly identify the screws

Règle - Utilisez cette règle pour aider à identifier correctement les vis

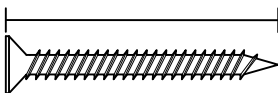
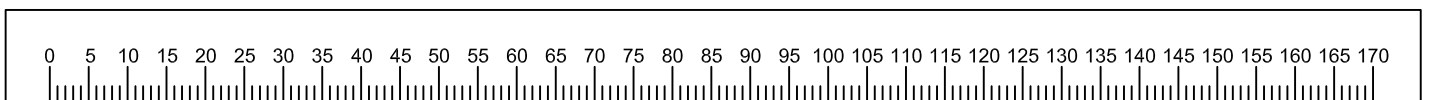

The screws length is measured from the head to the point (35mm screw shown)

La longueur de la vis est mesurée de la tête à la pointe (la vis de 35 mm est représentée)

WARNING: Risk of Shatter Associated with Glass Furniture

Please note that in rare instances, glass furniture that is damaged by chips or scratches may break seemingly of its own accord. Damage to the glass (not always visible) can get worse overtime until it reaches a critical point when it may shatter, in the event of damage, this product is designed to shatter into lots of small granular pieces rather than large shards. This is a safety feature to reduce the risk of injury.

To reduce the risk of damage, we recommend the following. During assembly do not lay the glass directly onto hard or rough surfaces. Lay the glass on a blanket or cardboard.

When lifting or moving the product, ask for someone to lend a hand.

Trying to move a product on your own can lead to accidents.

Do not use the furniture if any parts are missing or broken.

Do not place very hot or very cold items directly on the glass surface, we recommend using a trivet. Extreme temperature differences over small areas can cause damage, which could in turn lead to shattering.

Do not sit or stand on the glass surface.

Do not strike the glass with hard or pointed items, or use the glass as a chopping surface.

Do not drag rough or heavy objects over the top of the glass

ATTENTION: Risque d'éclatement associé aux meubles en verre

Veillez noter que, dans de rares cas, un meuble en verre endommagé par des éclats ou des rayures peut se briser apparemment de lui-même. Les dommages sur le verre (pas toujours visibles) peuvent s'aggraver avec le temps jusqu'à atteindre un point critique où il peut éclater. En cas de dommage, ce produit est conçu pour se briser en de nombreux petits fragments granulaires plutôt qu'en grands éclats coupants. Il s'agit d'une fonction de sécurité visant à réduire le risque de blessure.

Pour réduire le risque d'endommagement, nous recommandons ce qui suit :

- Lors de l'assemblage, ne posez pas le verre directement sur des surfaces dures ou rugueuses. Posez-le sur une couverture ou du carton.
- Lors du soulèvement ou du déplacement du produit, demandez à quelqu'un de vous aider. Essayer de déplacer un produit seul peut entraîner des accidents.
- N'utilisez pas le meuble si des pièces manquent ou sont cassées.
- Ne placez pas d'articles très chauds ou très froids directement sur la surface en verre; nous recommandons d'utiliser un dessous-de-plat. Des différences de température extrêmes sur de petites surfaces peuvent causer des dommages, ce qui pourrait à son tour entraîner un éclatement.
- Ne vous asseyez pas et ne vous tenez pas debout sur la surface en verre.
- Ne frappez pas le verre avec des objets durs ou pointus, et ne l'utilisez pas comme planche à découper.
- Ne traînez pas d'objets rugueux ou lourds sur le dessus du verre.

Assembly Instructions / Instructions de montage

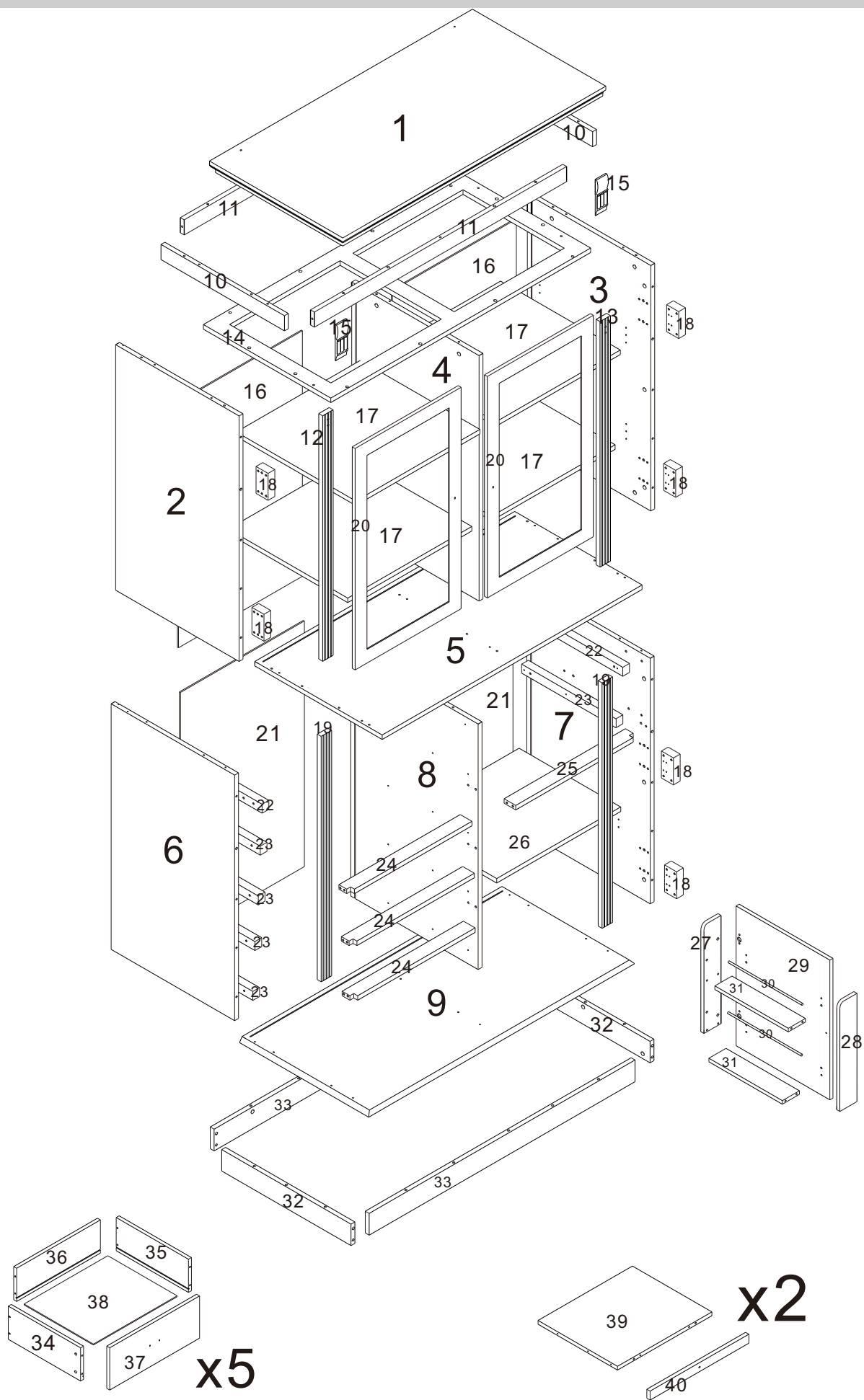























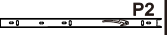

Components - Composants

Please check you have all the panels listed below

Veuillez vérifier que vous avez tous les panneaux énumérés ci - dessous

Note: The quantity below are the correct amount to complete the assembly. In some cases more fittings may be supplied than are required.

Remarque: les quantités suivantes sont les quantités correctes pour l'assemblage terminé. Dans certains cas, plus d'accessoires que nécessaire peuvent être fournis.

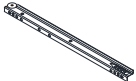
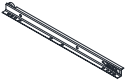
A x 84 	B x 84 	C x 102 	D x 88  Ø3x12mm	E x 10  Ø4x65mm	F x 66  Ø4x30mm	G x 36  Ø4x14mm	H x 5  Ø4x20mm
I x 10  Ø4x15mm	J x 12  Ø4x40mm	K x 4  Ø4x20mm	L x 20 	M x 20 	N x 16 	O x 16  Ø3x16mm	P x 4  
Q x 2 	R x 2 	S x 6 	T x 3 	U x 5 	V x 2 	CL x 5 	CR x 5 
DL x 5 	DR x 5 						

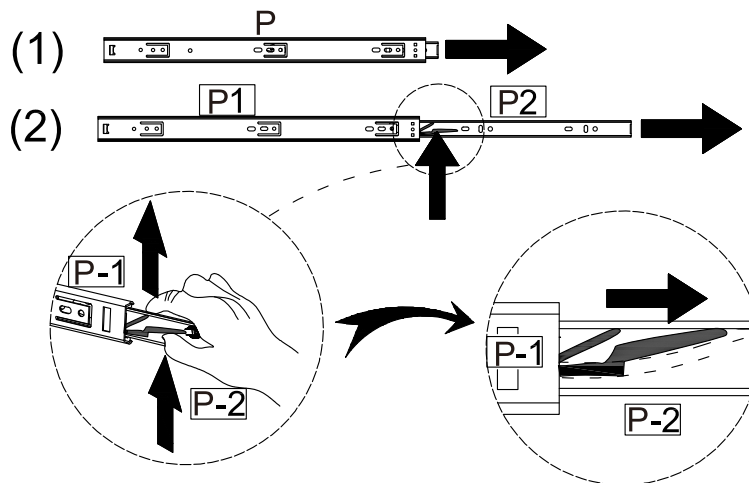





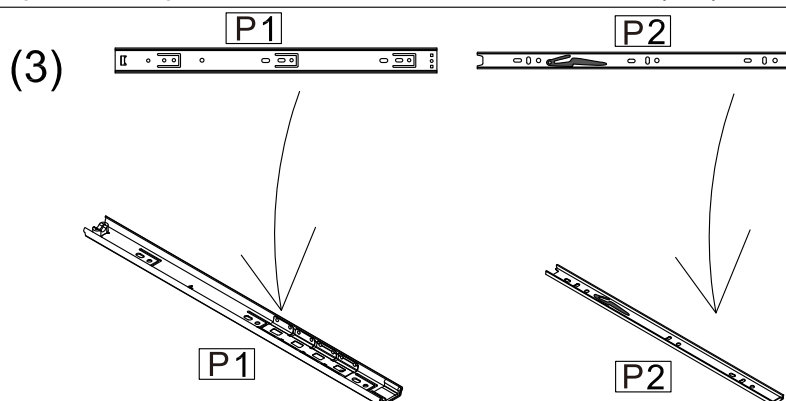

Move the black paddle upward and pull out (P2) to the right.

Déplacez la palette noire vers le haut et tirez (P2) vers la droite

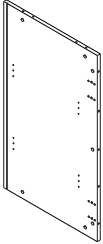
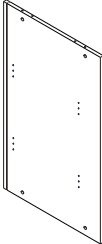
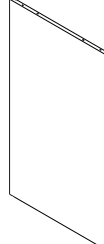
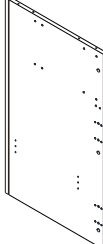

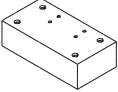
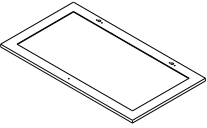

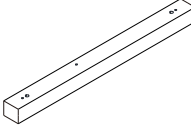
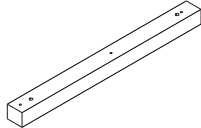
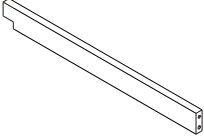
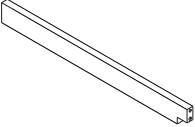
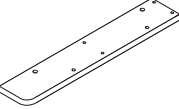
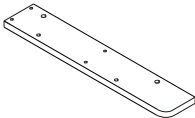
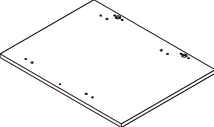
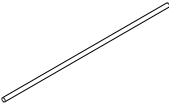
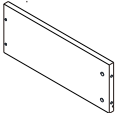
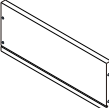
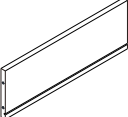
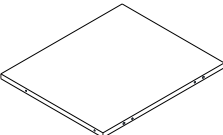

Assembly Instructions / Instructions de montage

N717P399852 CARTON CONTENT/CONTENU DU CARTON

 3 x 1pc	 4 x 1pc	 6 x 1pc	 7 x 1pc	 8 x 1pc	 15 x 2 pcs
 18 x 6 pcs	 20 x 2 pcs	 21x 2 pcs	 22 x 2 pcs	 23 x 5 pcs	 24 x 3 pcs
 25 x 1pc	 27x 1pc	 28x 1pc	 29 x 1pc	 30 x 2 pcs	 34 x 5pcs
 35 x 1pc	 36 x 5pcs	 39 x 2pcs		 HARDWARE BOX le matériel	

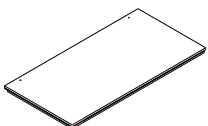
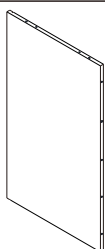
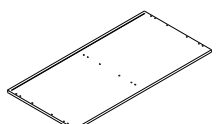
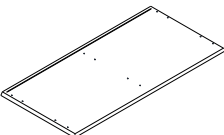
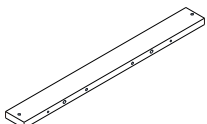
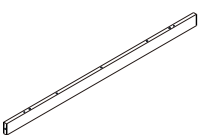
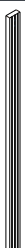
Assembly Instructions / Instructions de montage

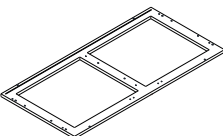
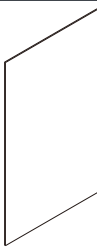
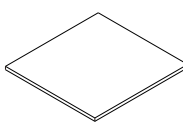
N717P399853 CARTON CONTENT/CONTENU DU CARTON

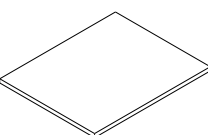
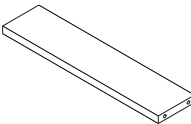
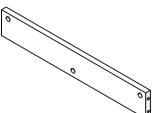
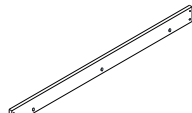
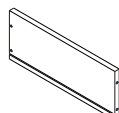
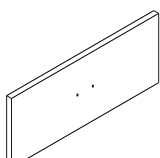
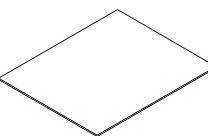
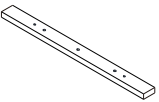
					
1 x 1pc	2 x 1pc	5 x 1pc	9 x 1pc	10 x 2pcs	11 x 2pcs
					
12 x 1pc	13 x 1pc	14 x 1pc	16 x 2pcs	17 x 4pcs	19 x 2pcs
					
26 x 1pc	31 x 2pcs	32 x 2pcs	33 x 2pcs	35 x 4pcs	37 x 5pcs
					
38 x 5pcs	40 x 2pcs				

Step 1
Étape 1

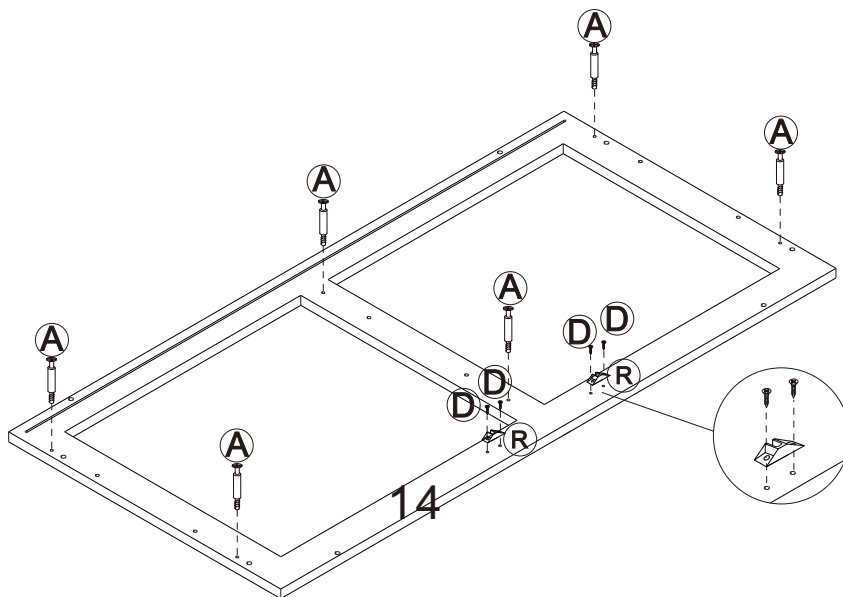
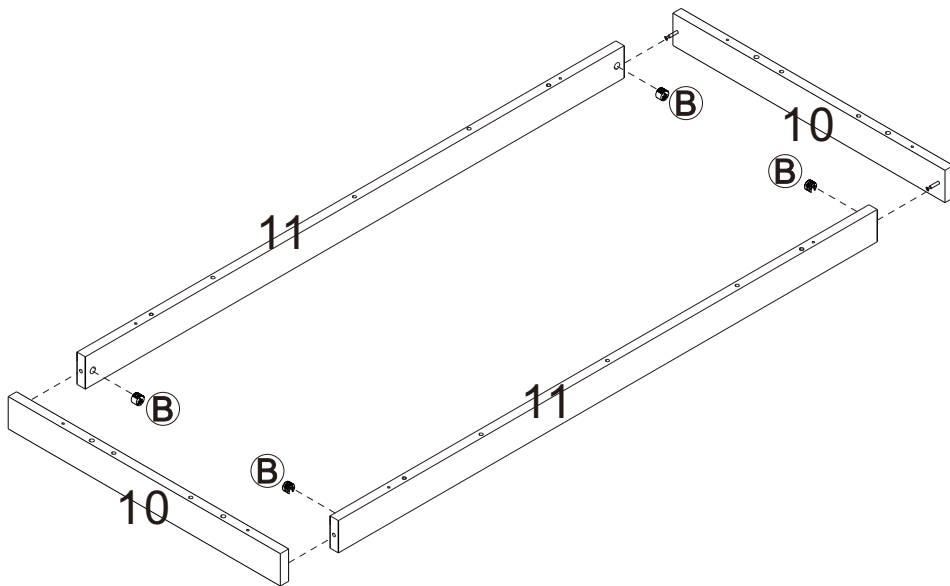
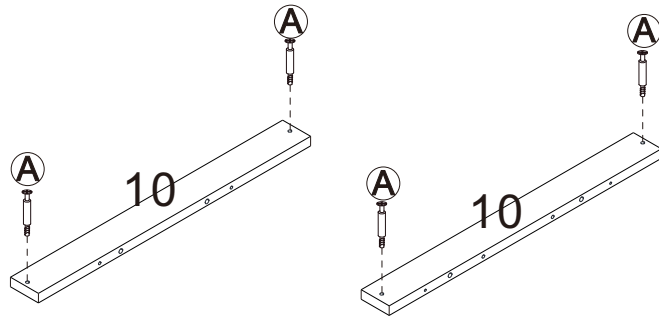

A x 10



B x 4



D x 4



R x 2

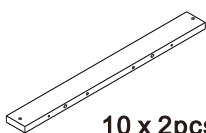

10 x 2pcs

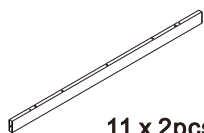

11 x 2pcs

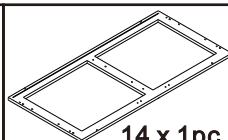

14 x 1pc

Step 2
Étape 2

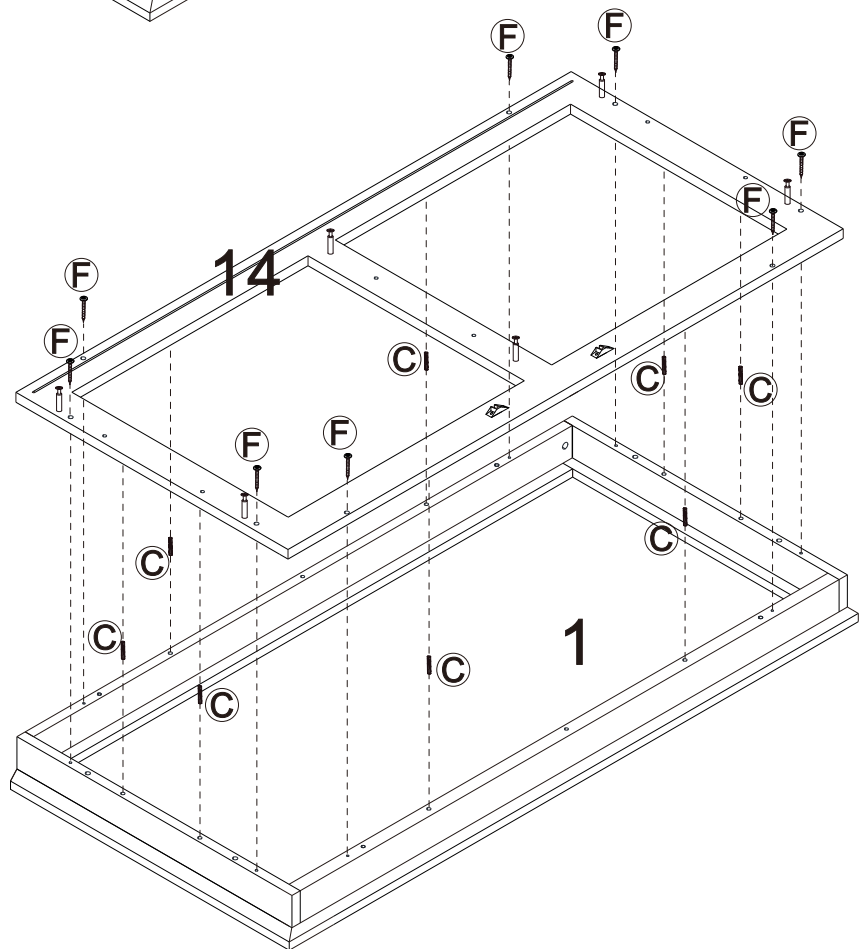
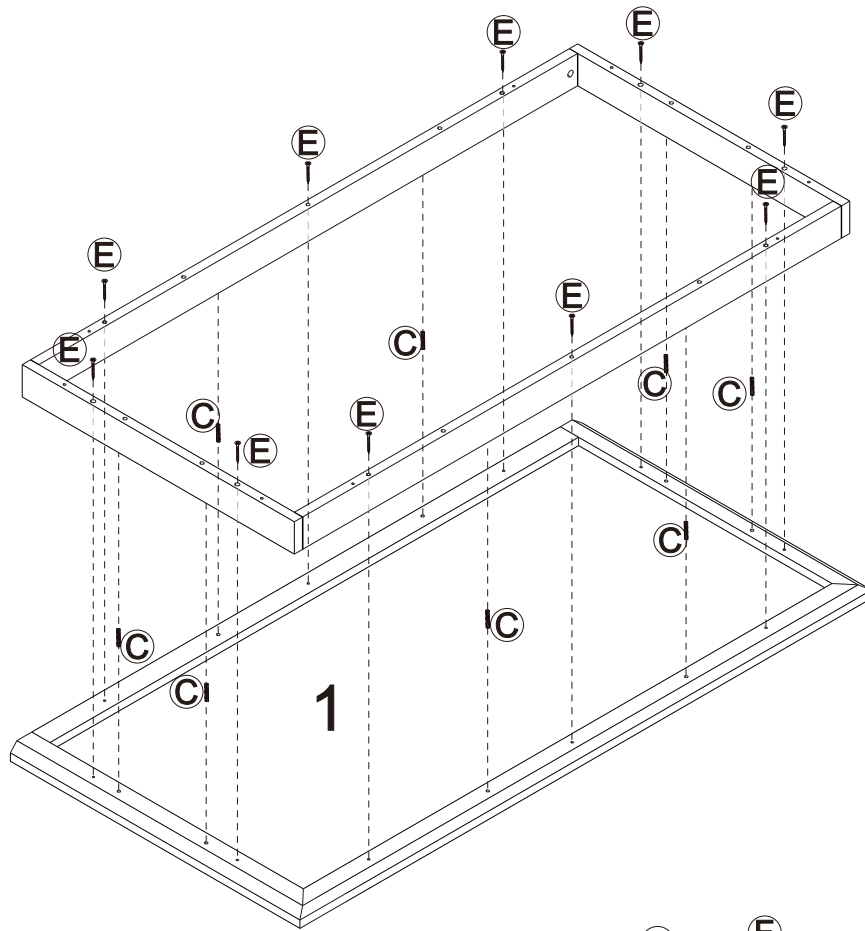

C x 16



E x 10



F x 8

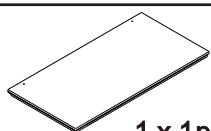

1 x 1pc

Step 3
Étape 3

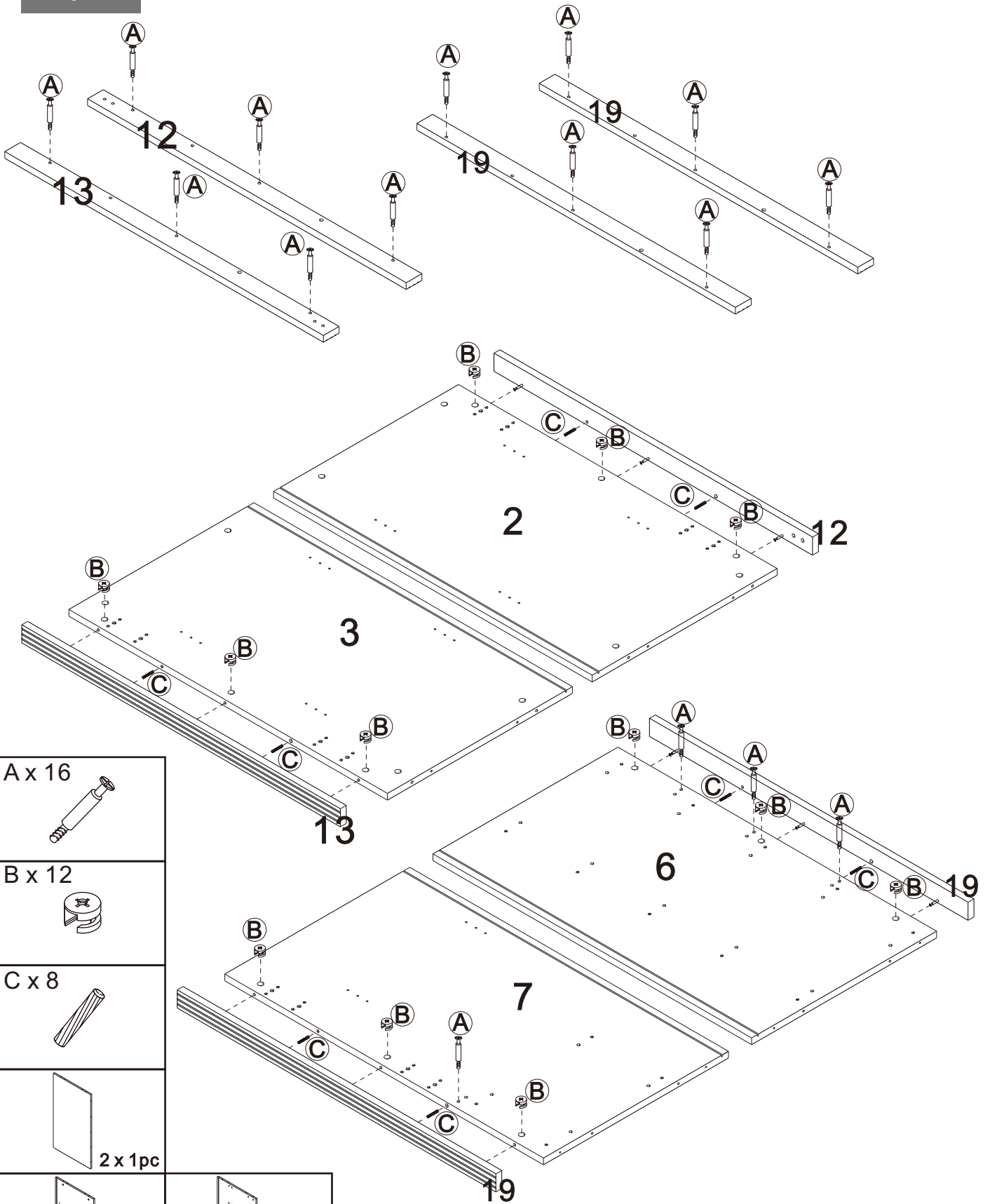

A x 16



B x 12



C x 8



2 x 1pc



3 x 1pc



7 x 1pc

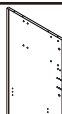

6 x 1pc

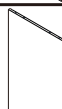

12 x 1pc



13 x 1pc

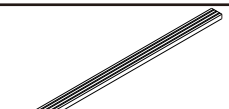

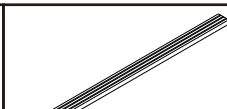

19 x 2pcs

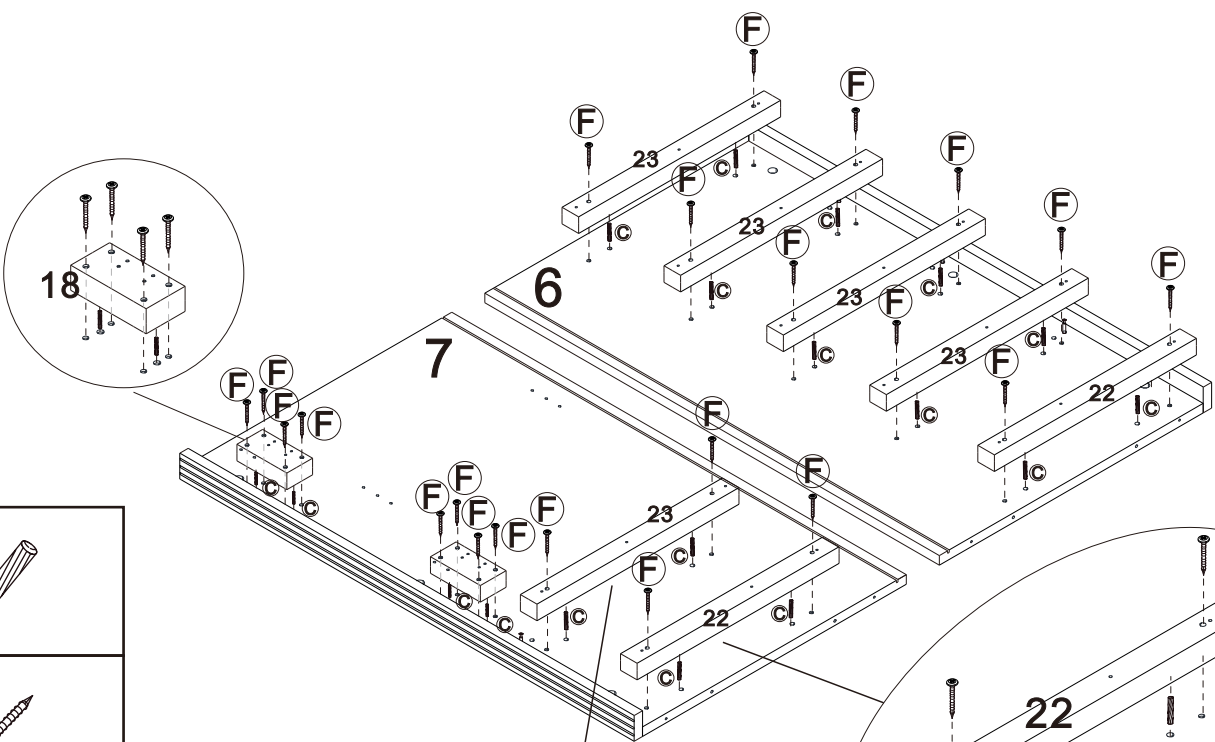
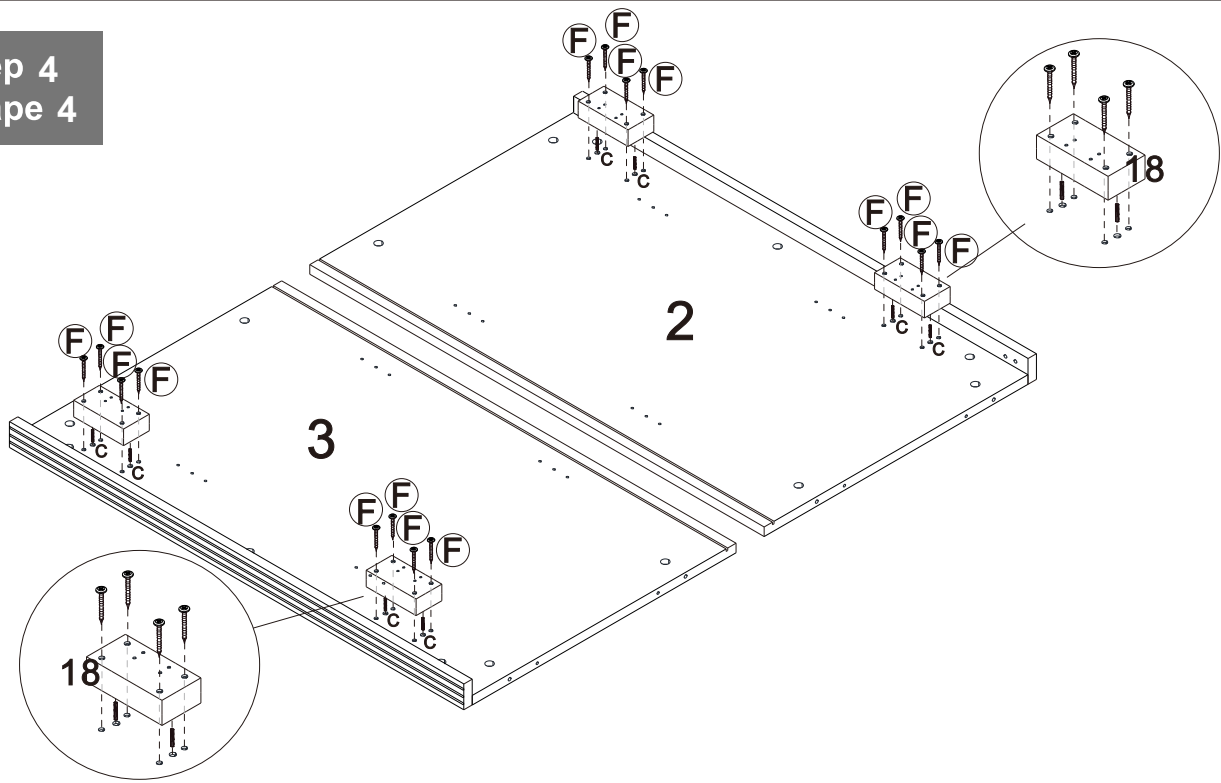

P13

Step 4
Étape 4

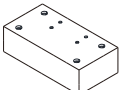
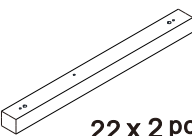
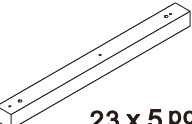

- C x 26

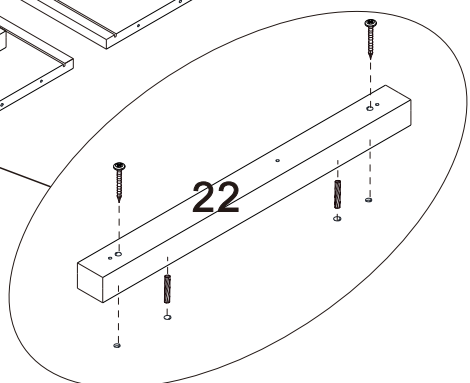
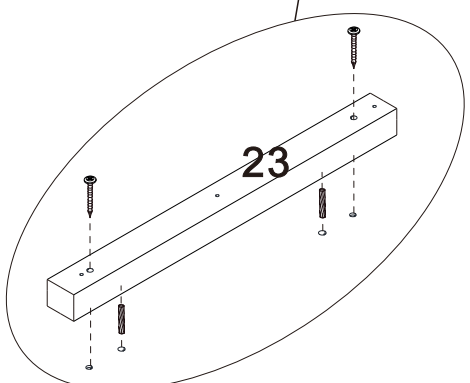
- F x 38

- 
18 x 6 pcs
- 
22 x 2 pcs
- 
23 x 5 pcs

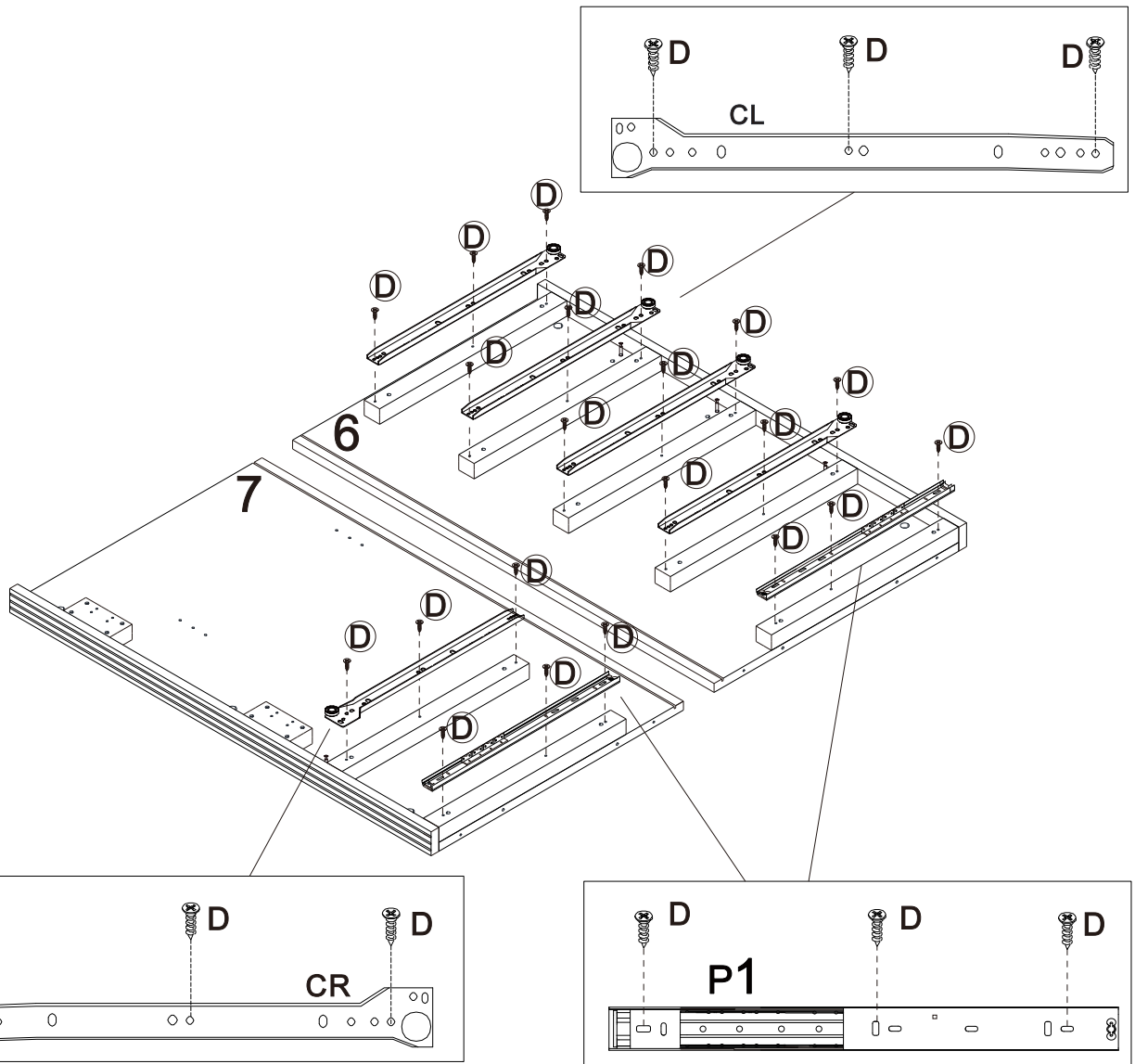

Step 5
Étape 5



D x 21



P1 x 2

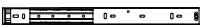

CL x 4







CR x 1

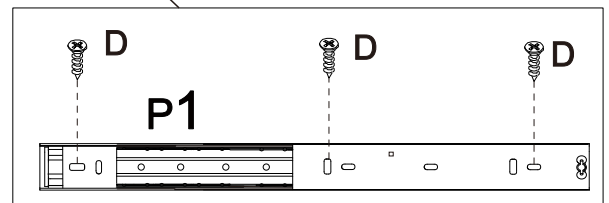
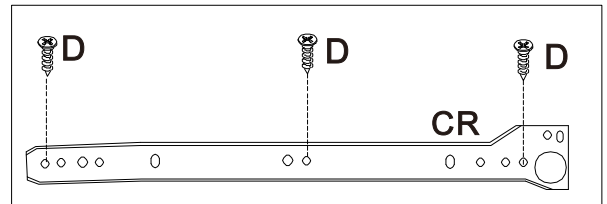
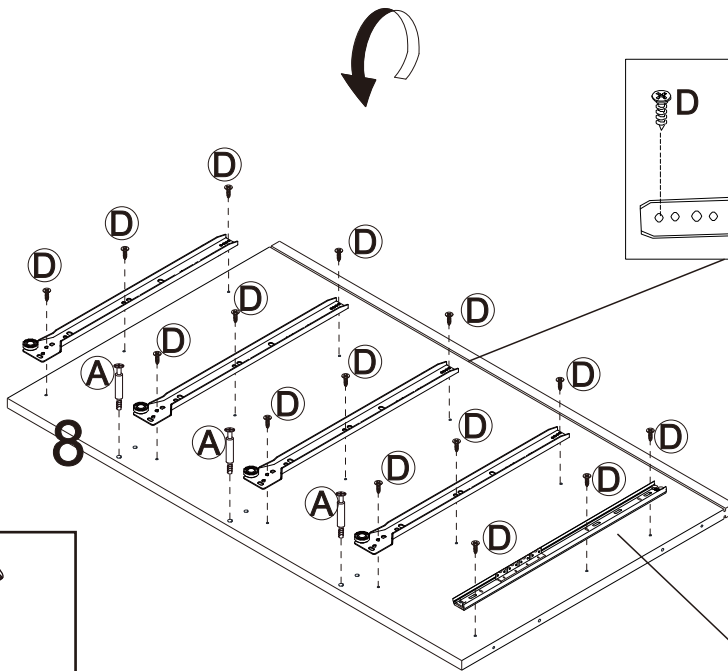
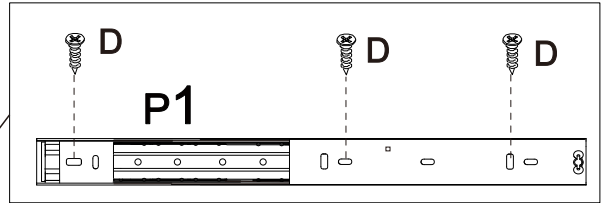
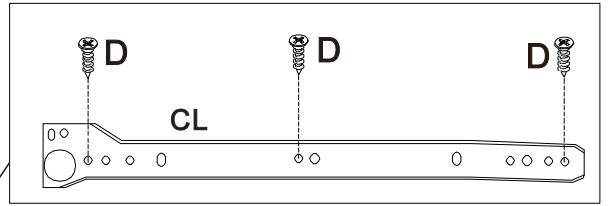
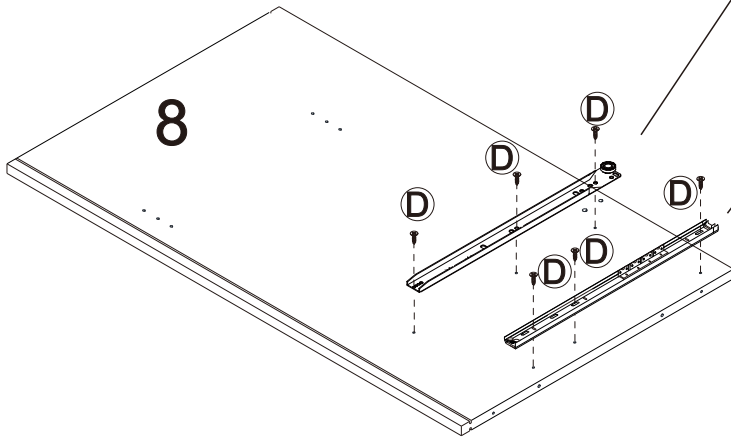

Step 6
Étape 6

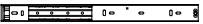

- A x 3 
- D x 21 
- P1 x 2 
- CL x 1 
- CR x 4 

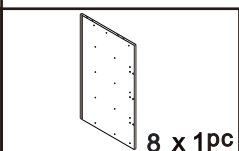

Step 7
Étape 7

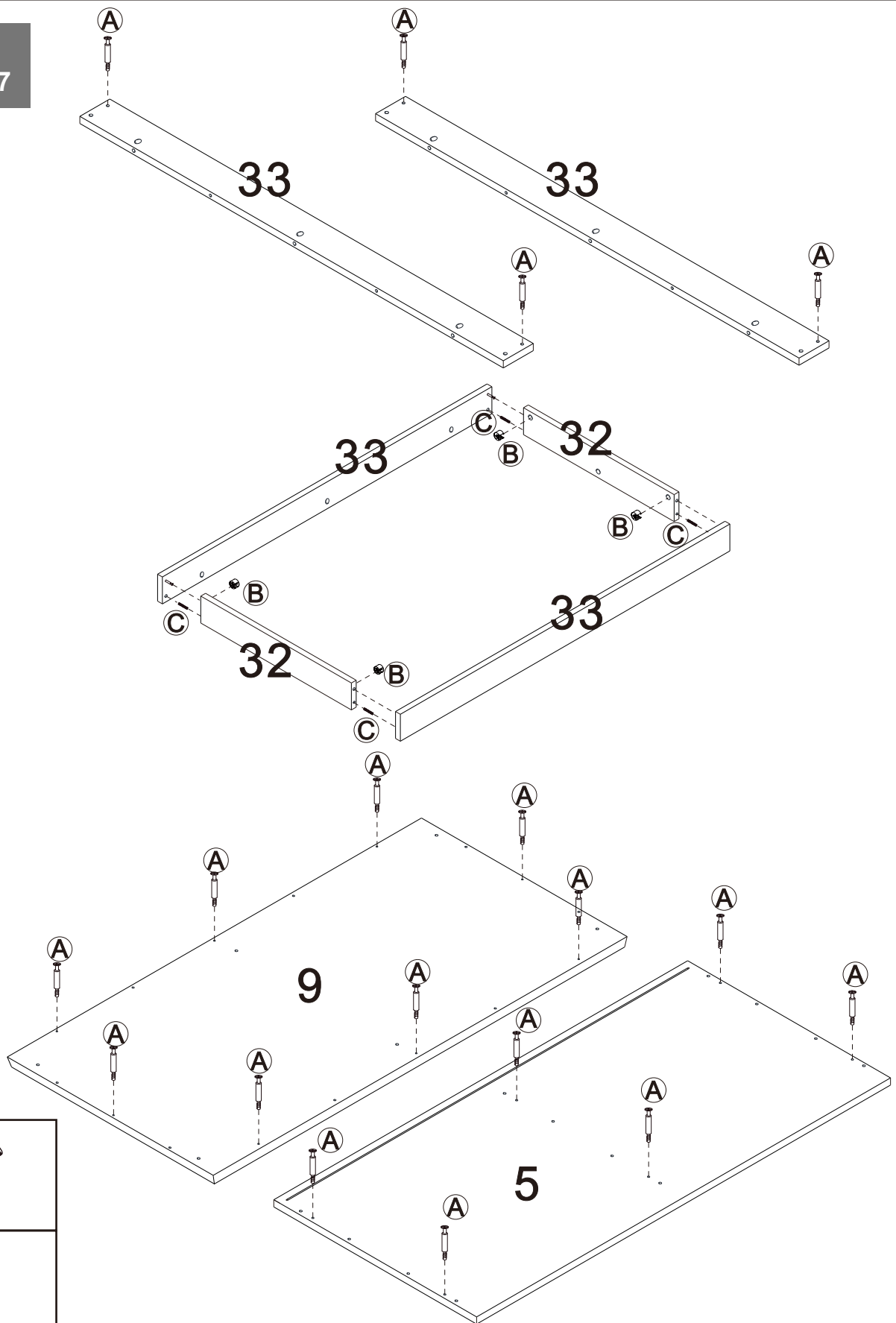

A x 18



B x 4



C x 4

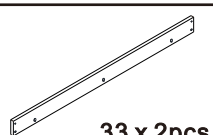
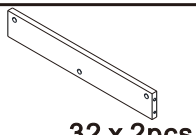
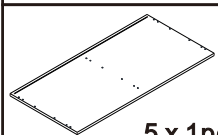
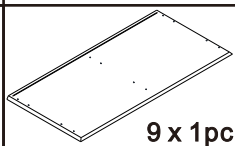

Step 8
Étape 8

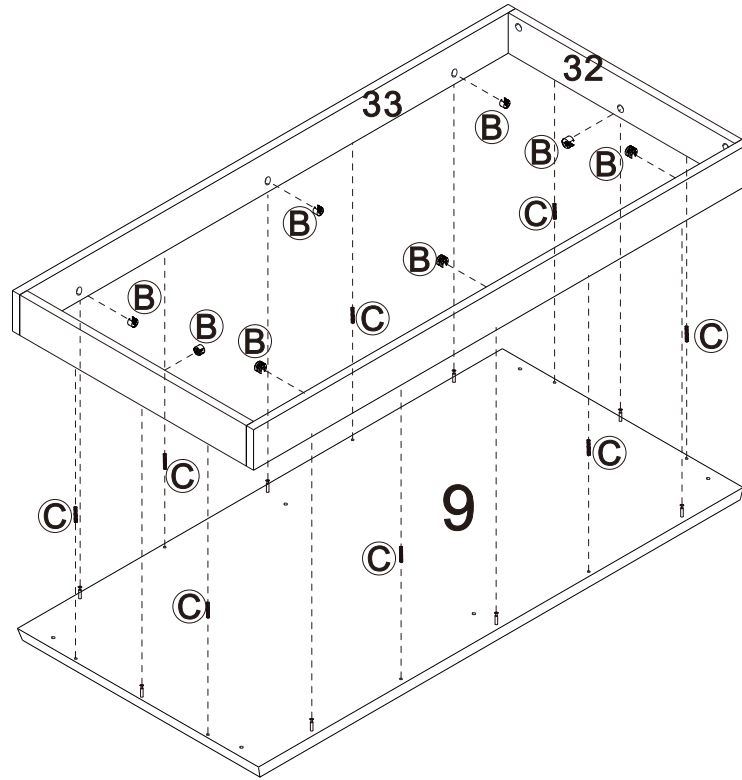

B x 8



C x 8



Step 9
Étape 9

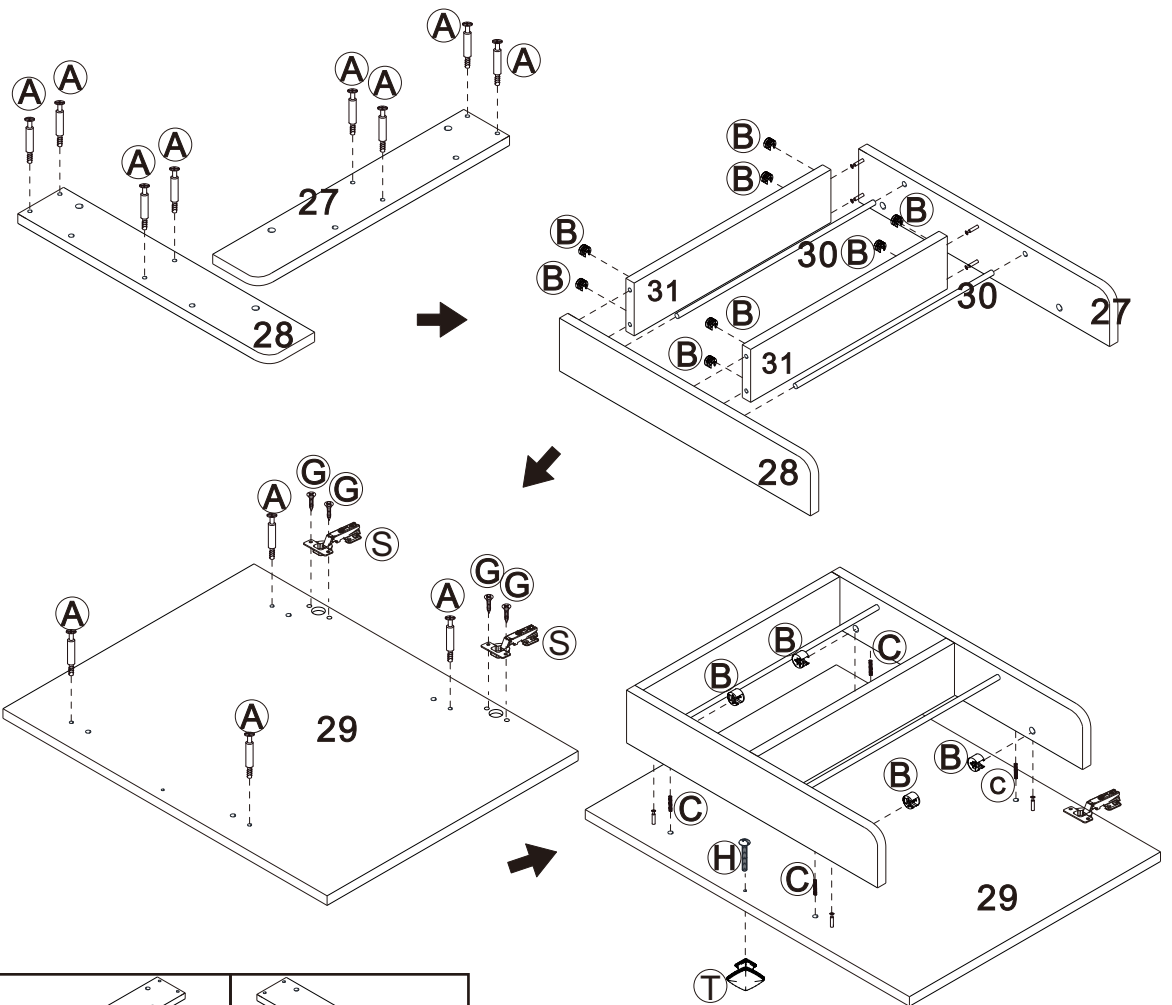

A x 12



B x 12



C x 4



G x 4



H x 1



S x 2

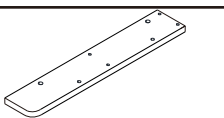

27x 1pc

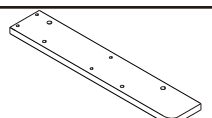

28x 1pc

T x 1

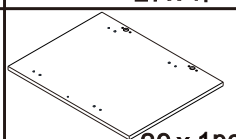

29x 1pc

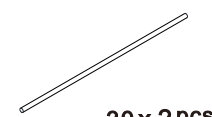

30x 2pcs

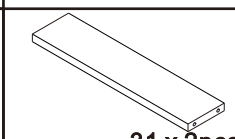

31x 2pcs

Step 10
Étape 10

P2

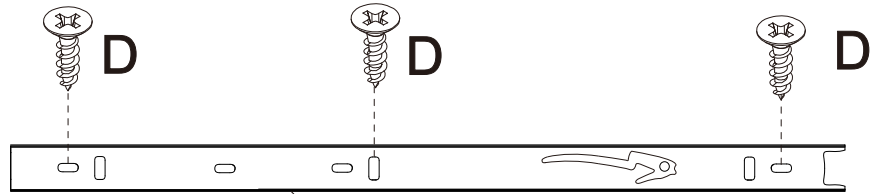

A x 4



B x 4



C x 4



D x 12



H x 2



V x 2



P2 x 4

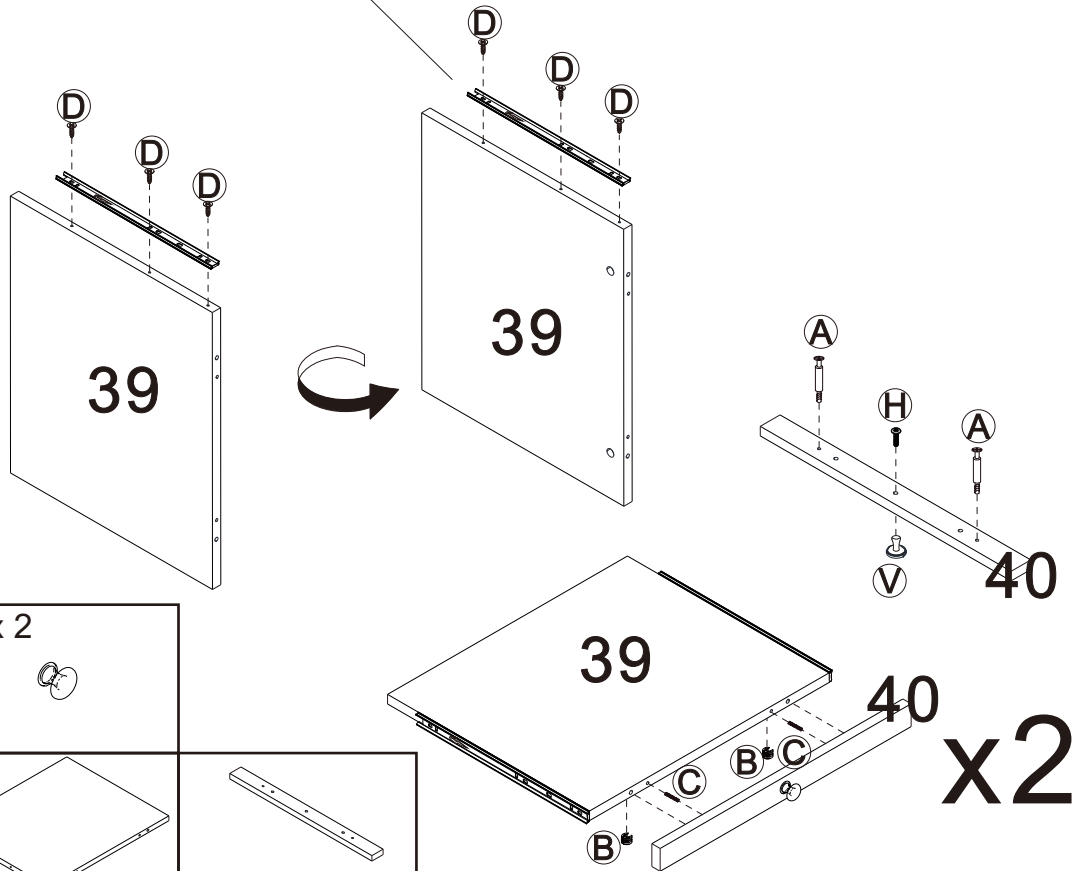
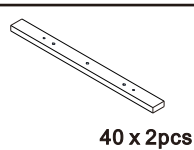
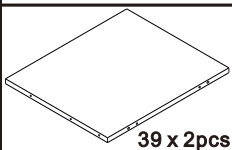
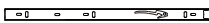

x2

Step 11
Étape 11

G x 8



H x 2



S x 4



T x 2

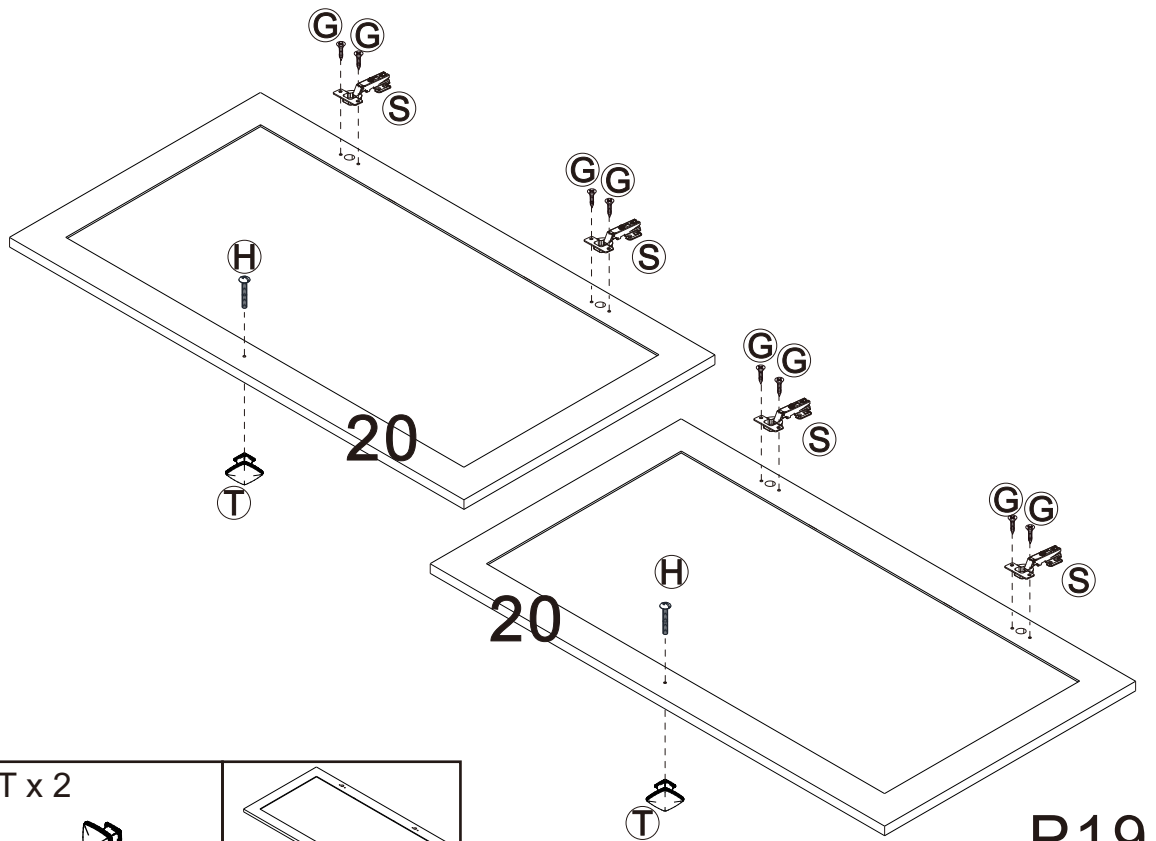
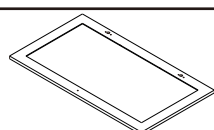

P19

20 x 2 pcs

Step 12
Étape 12

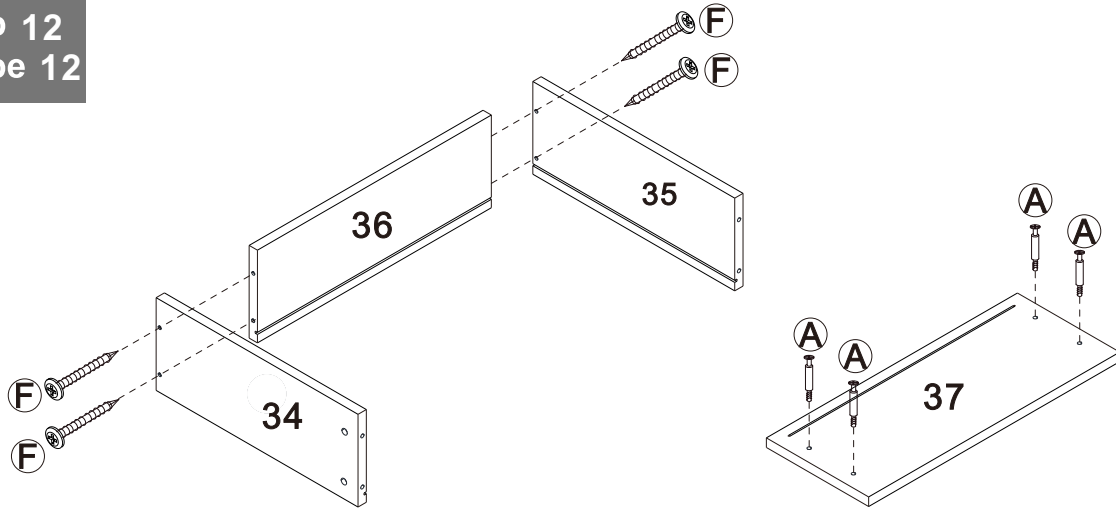

A x 20



B x 20



D x 30



F x 20



I x 10



U x 5



DL x 5

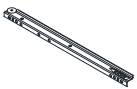

DR x 5

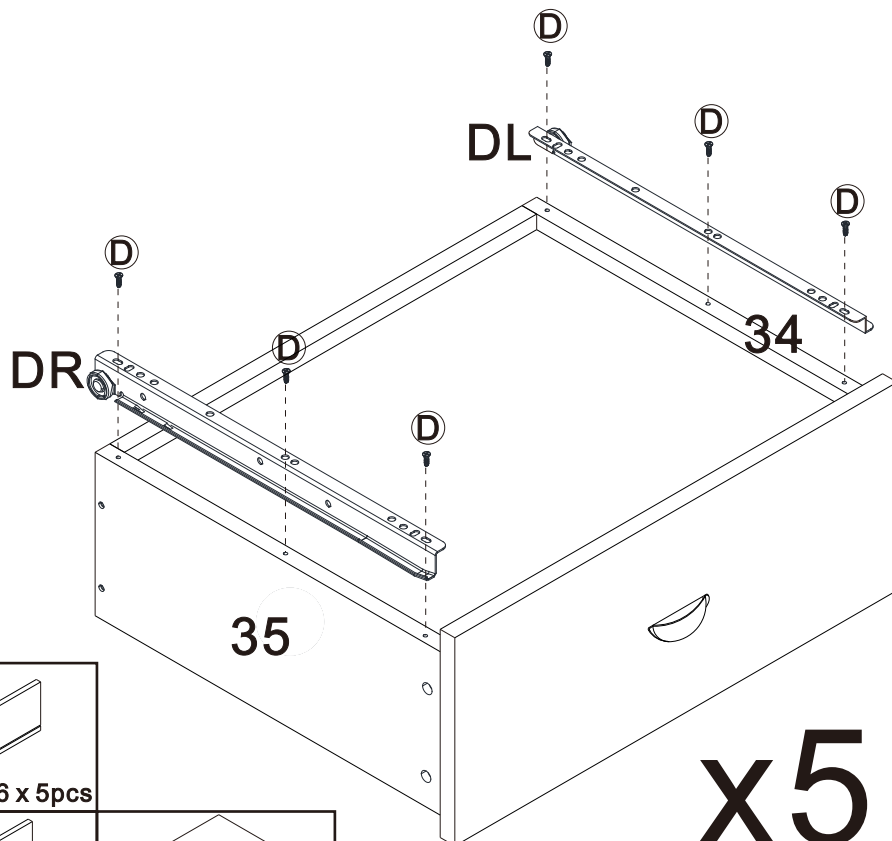
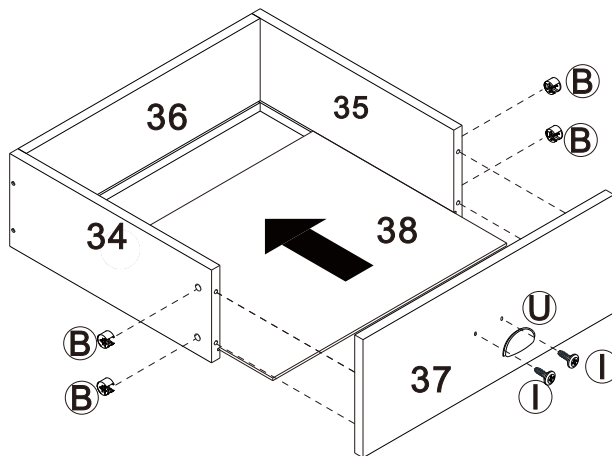
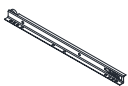

34 x 5pcs

36 x 5pcs

35 x 5pcs

37 x 5pcs

38 x 5pcs

x5

P20

Step 13
Étape 13

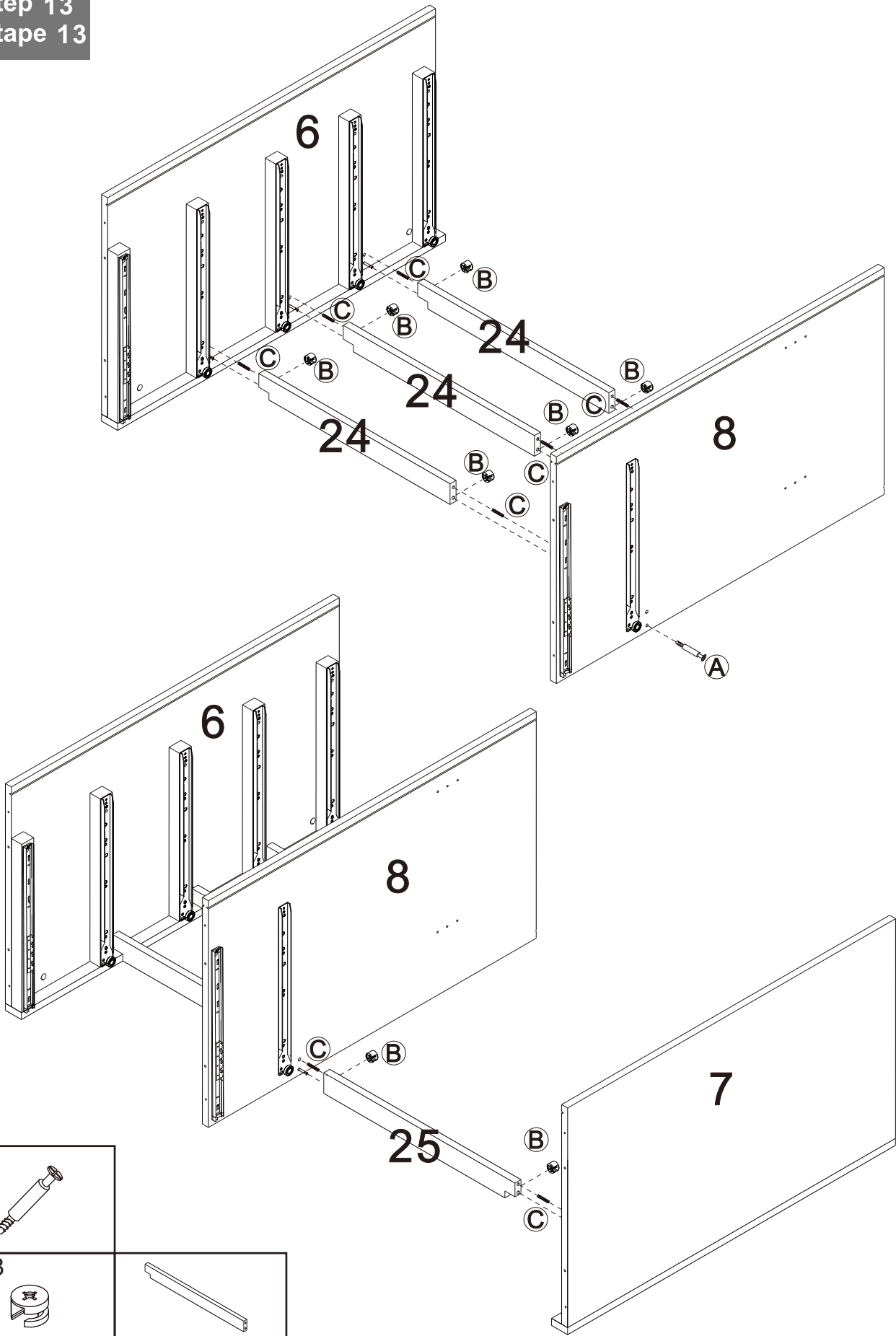

A x 1



B x 8

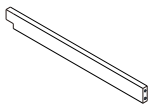

24 x 3 pcs

C x 8

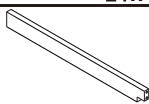

25 x 1 pc

Step 14
Étape 14

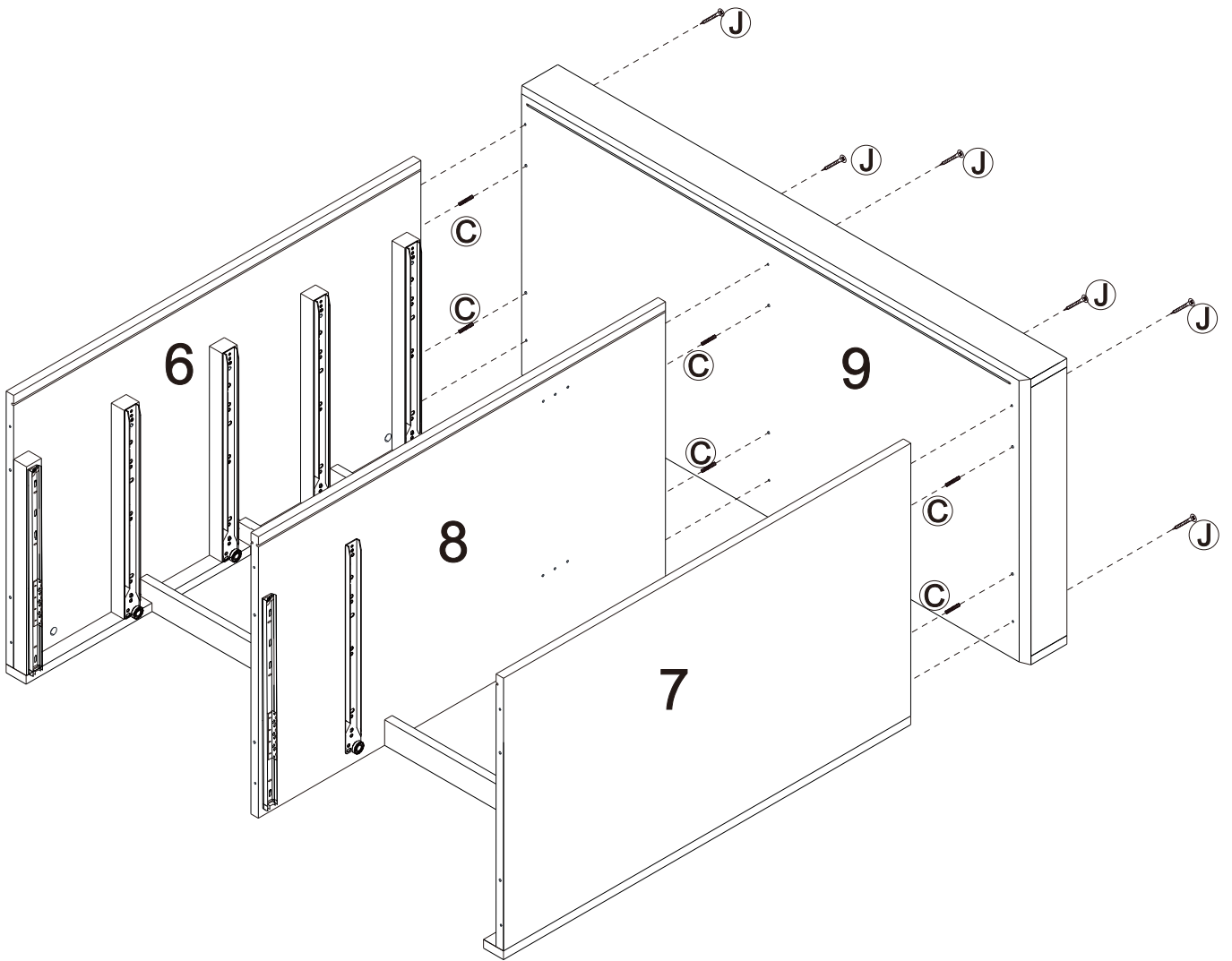

C x 6



J x 6



Step 15
Étape 15

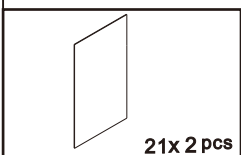
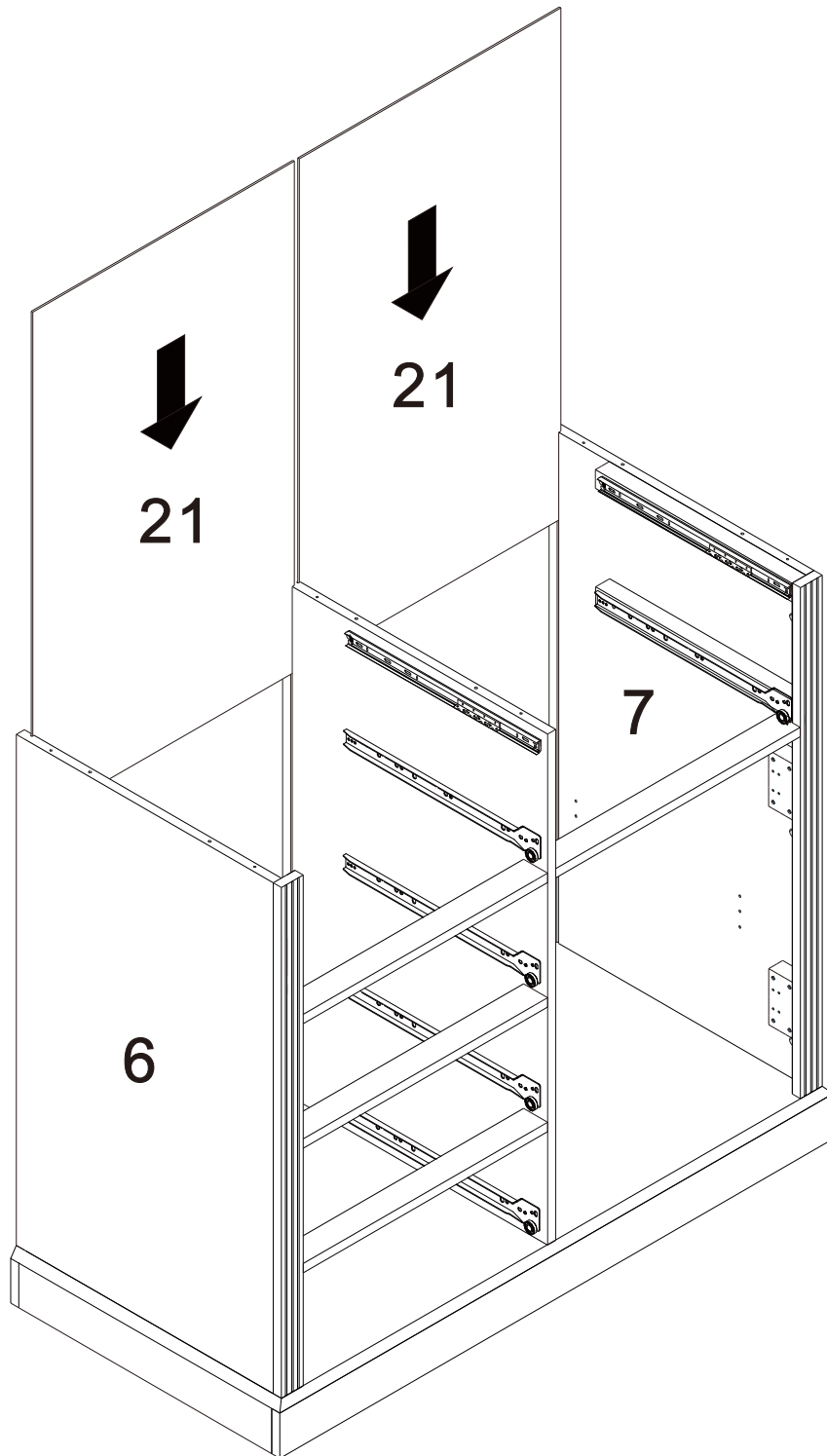

Step 16
Étape 16

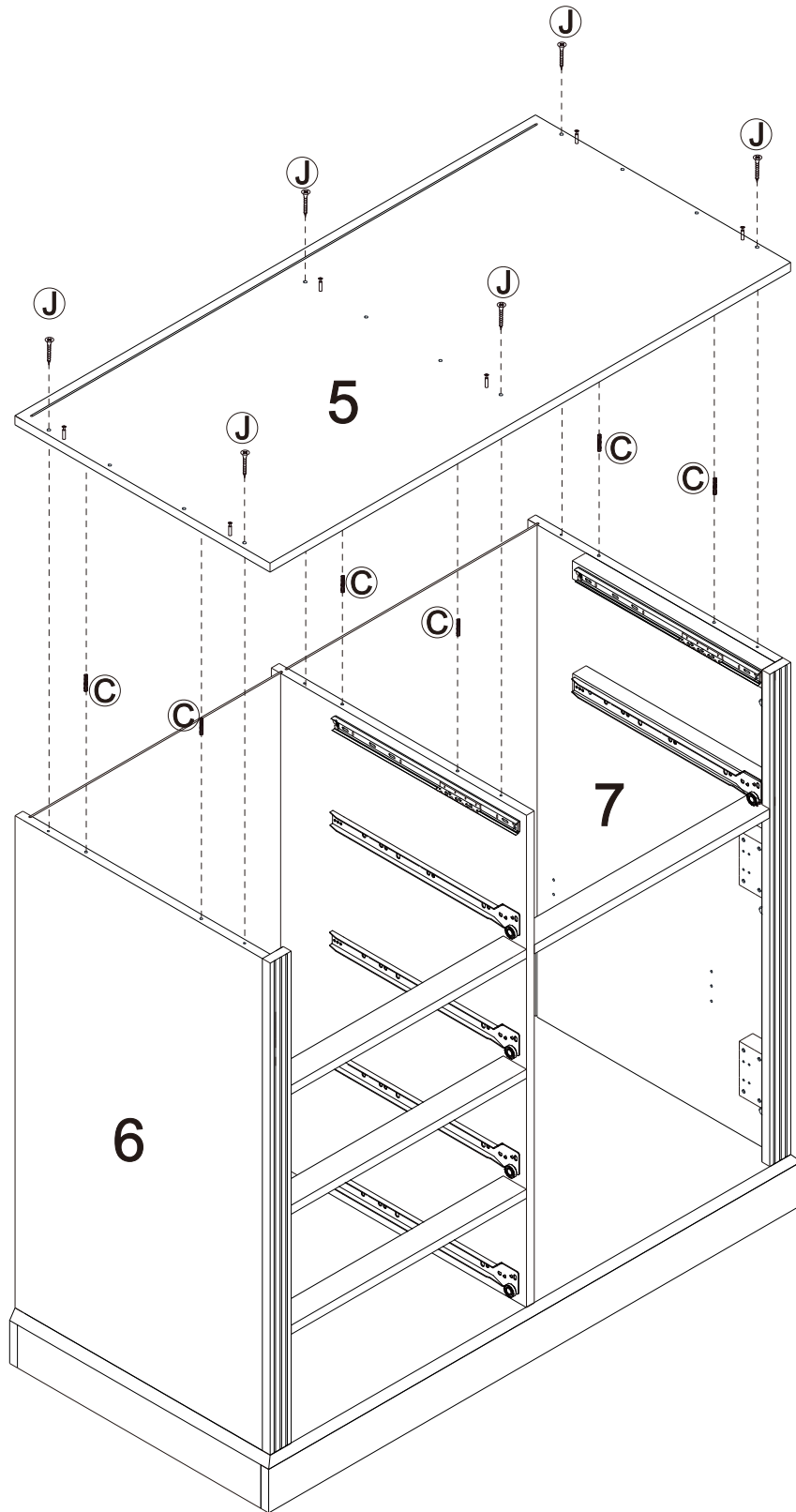

C x 6



J x 6



Step 17
Étape 17

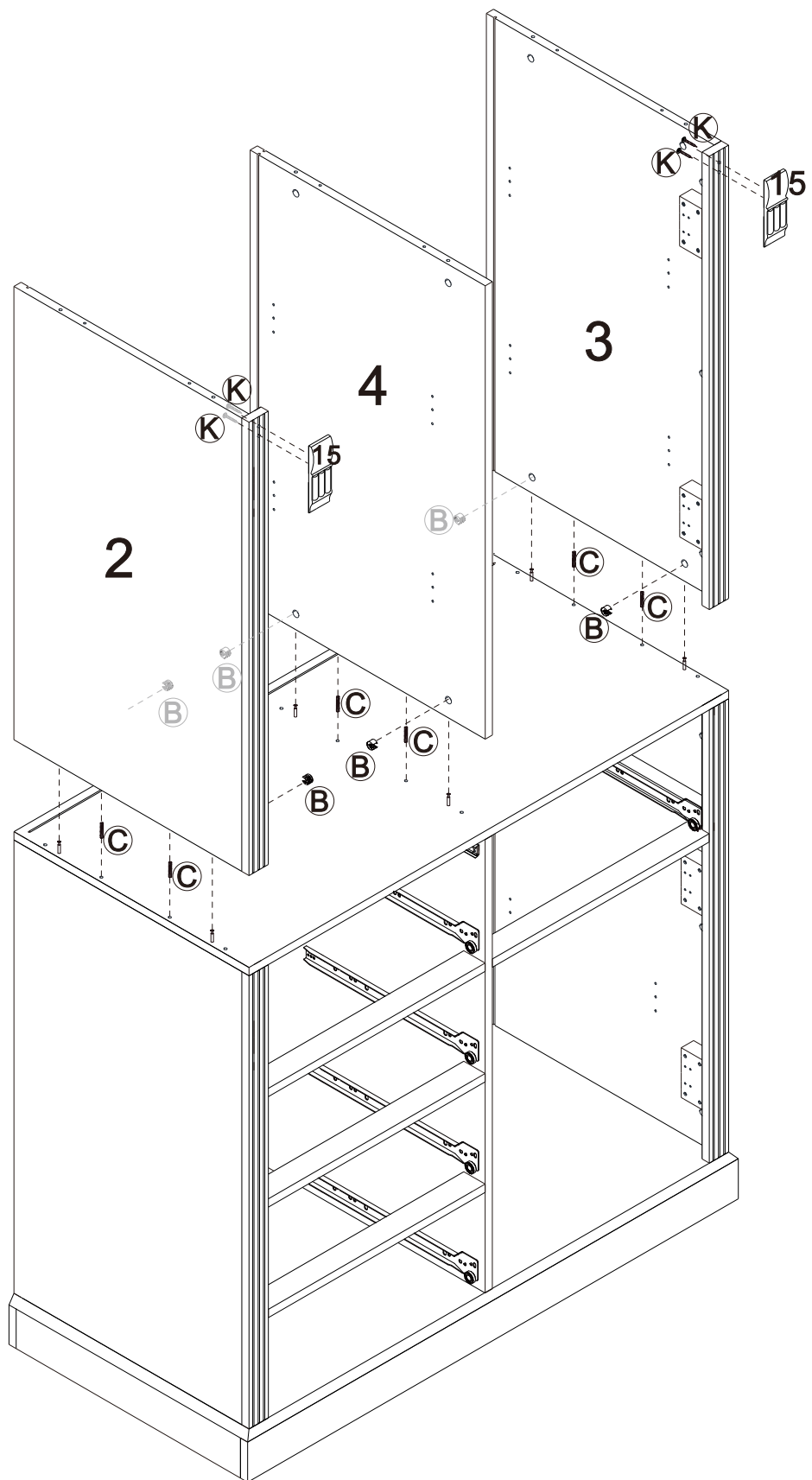

B x 6



C x 6



K x 4



15 x 2 pcs

P25

Step 18
Étape 18

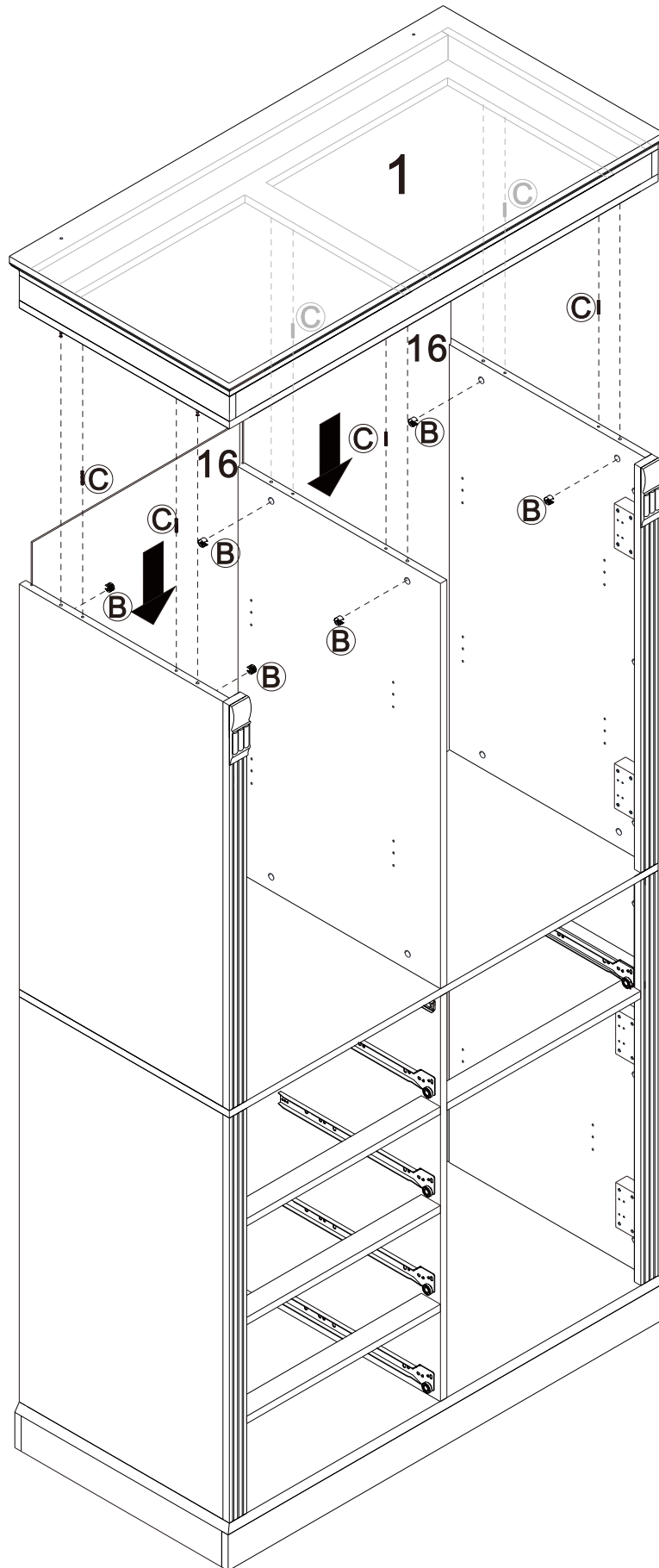

B x 6



C x 6

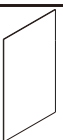

16 x 2pcs

Step 19
Étape 19

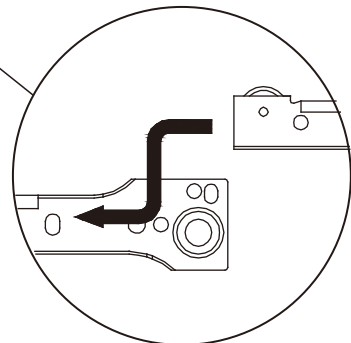
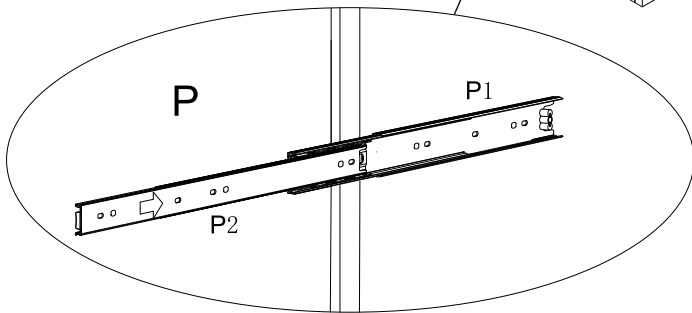
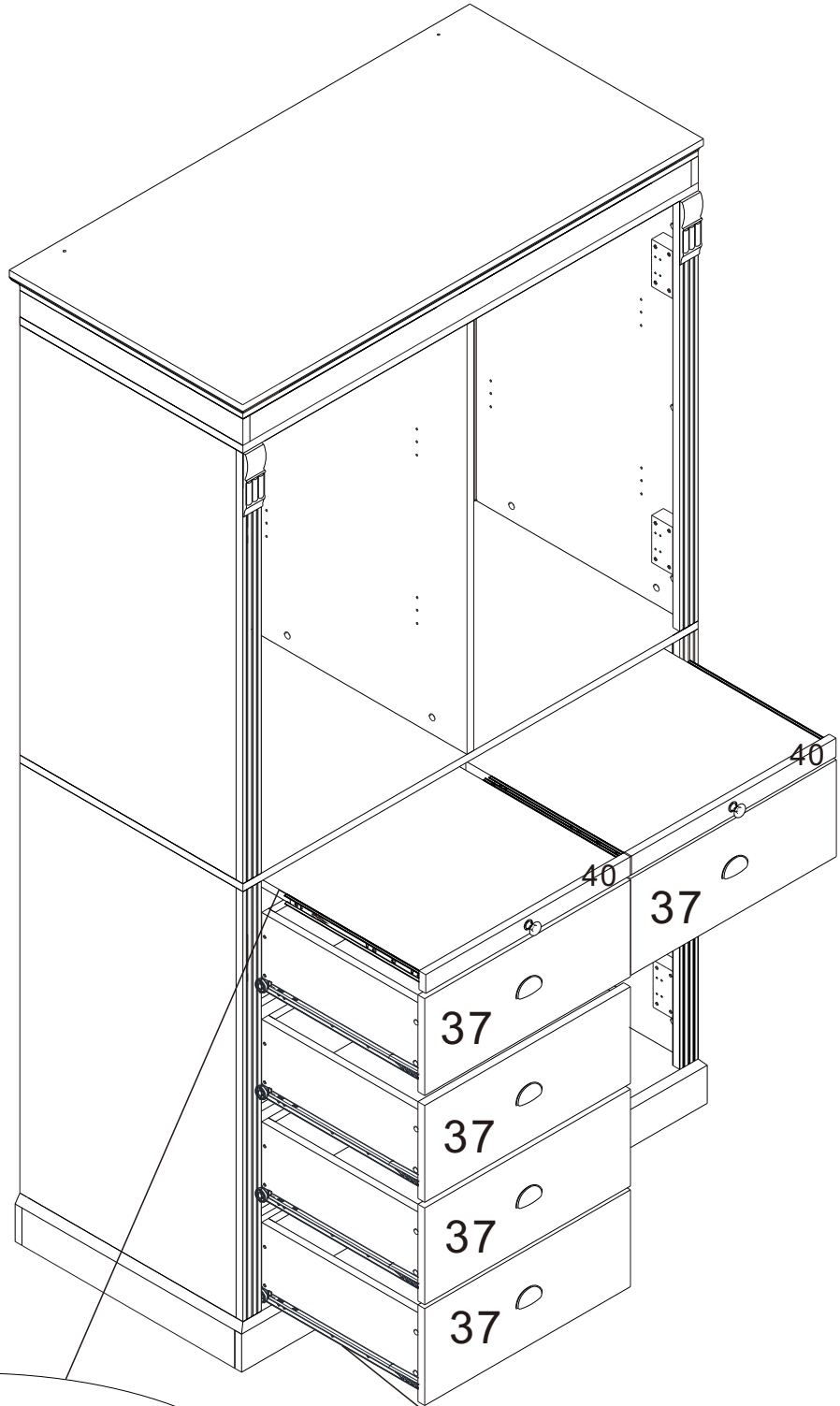

Step 20
Étape 20

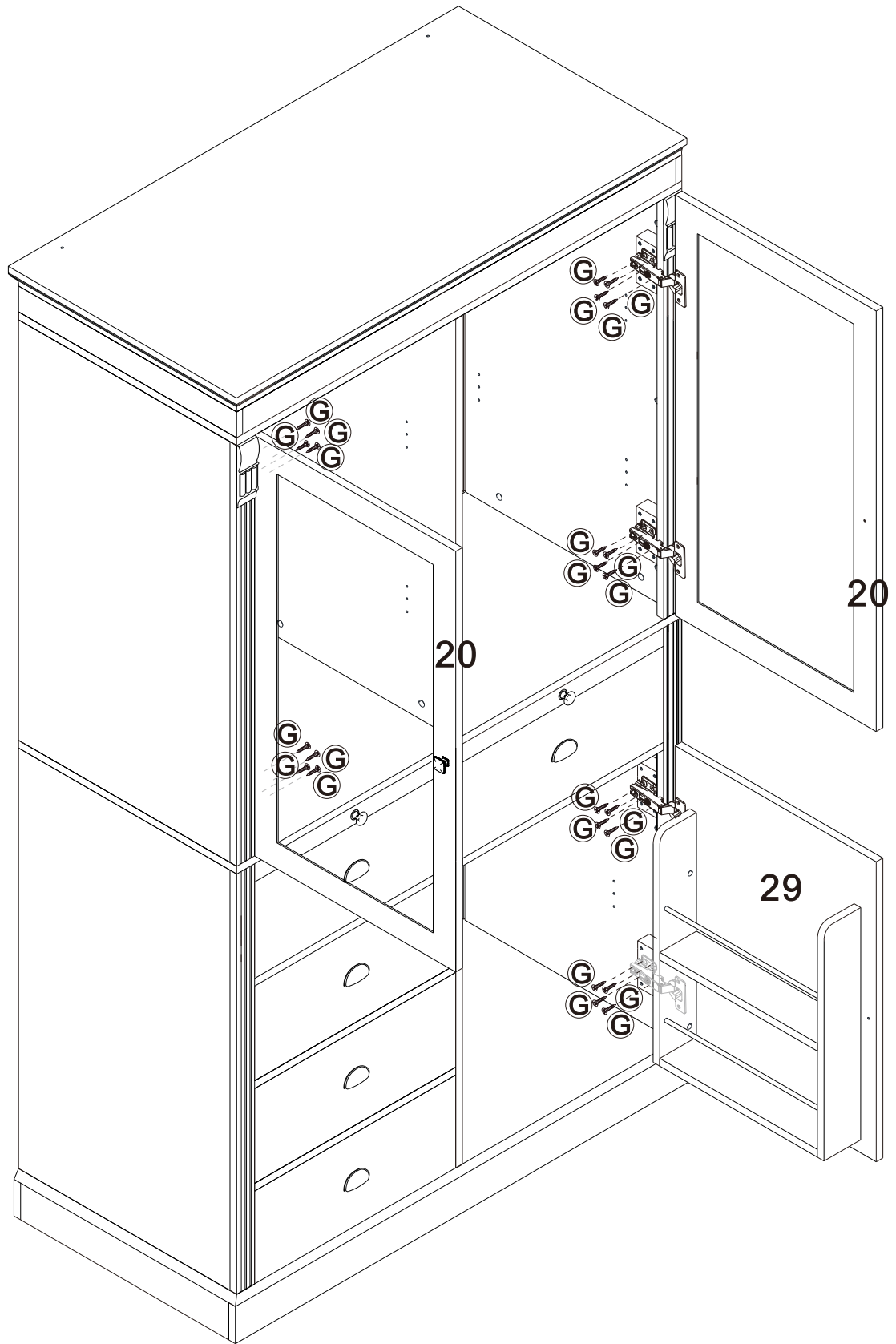



G x 24



P28

Step 21
Étape 21

- 1
M 
- 2
M 
- 3
M 

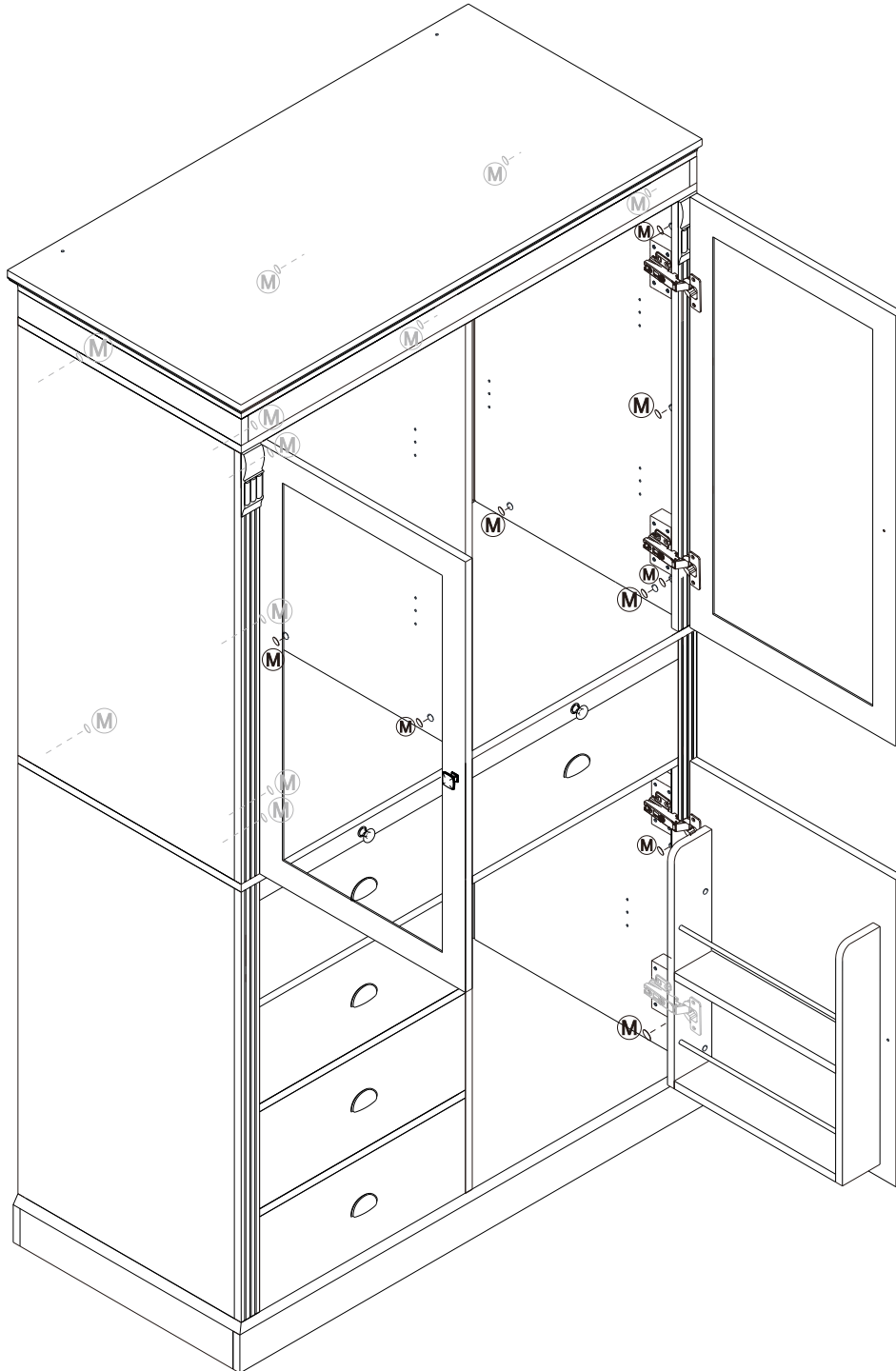

M x 20



P29

Step 22
Étape 22

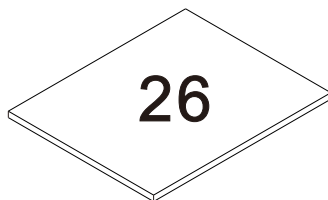
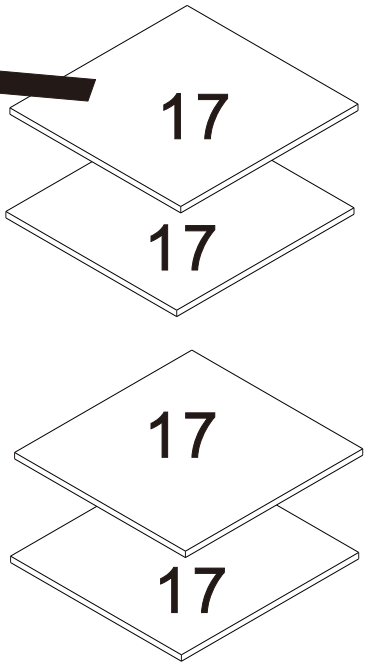
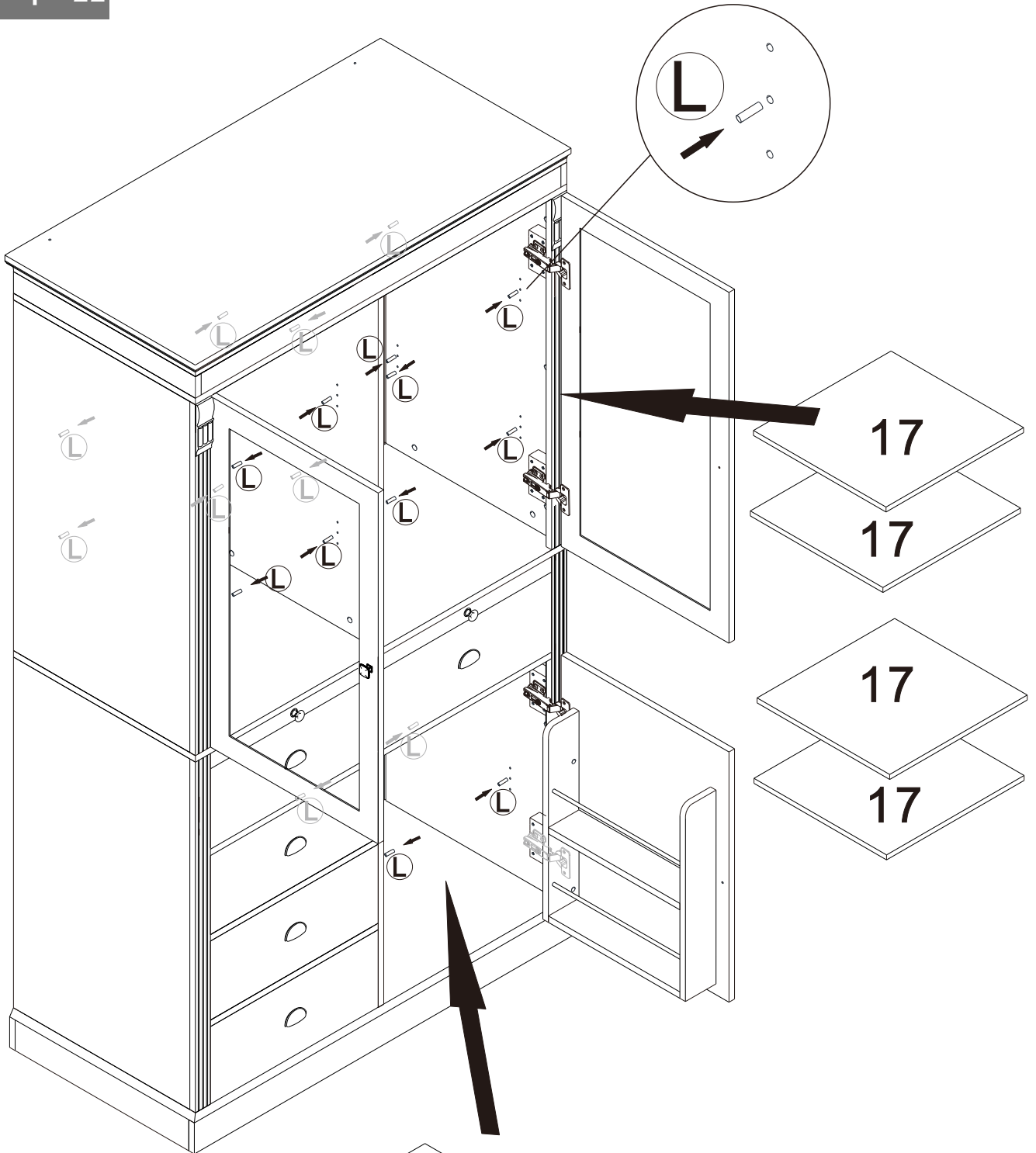

L x 20

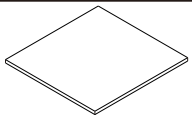

17 x 4pcs

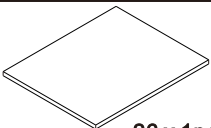

26 x 1pc

P30

Step 23
Étape 23

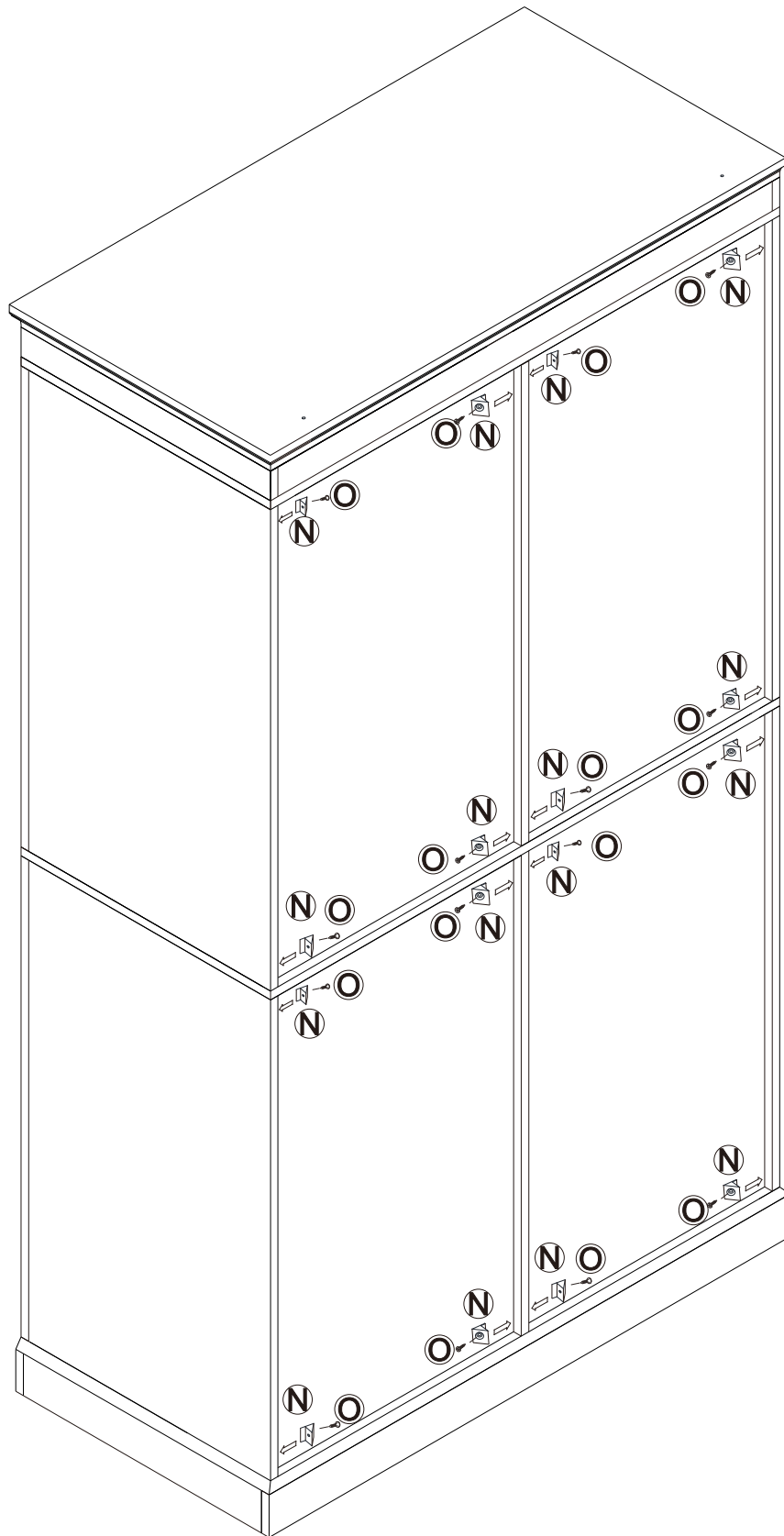

N x 16



O x 16



Step 24
Étape 24

