

DIMENSIONS

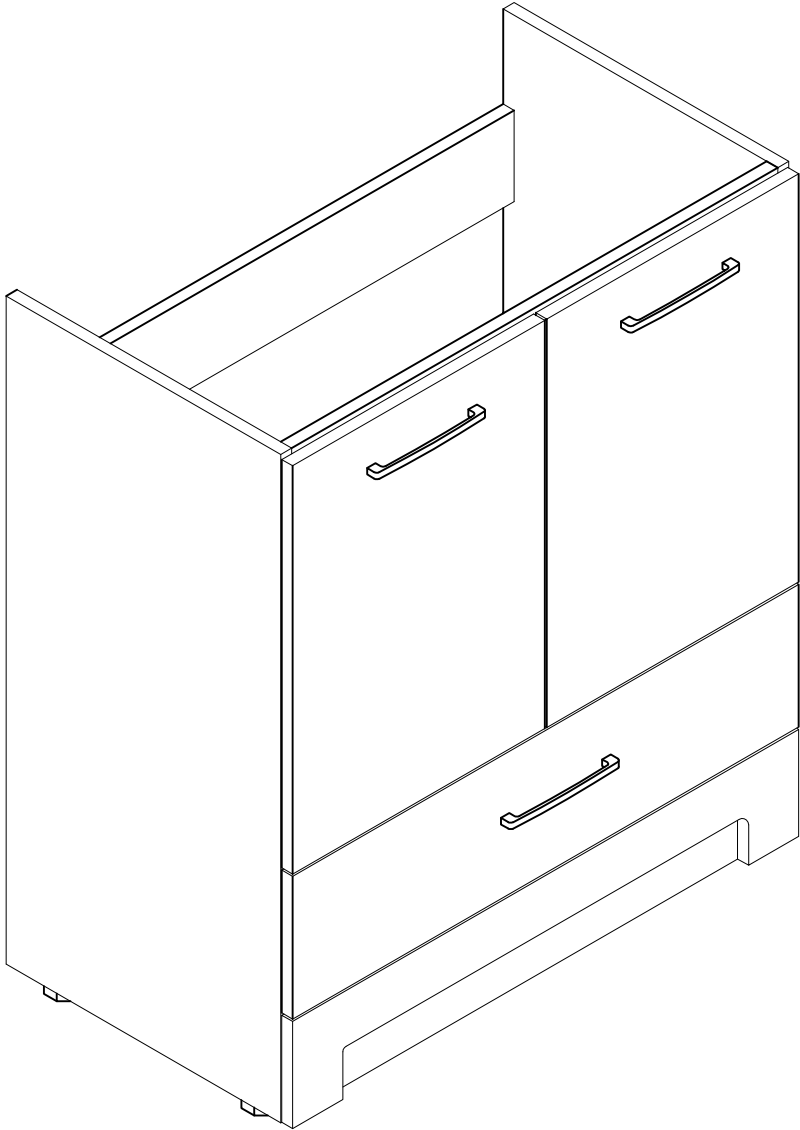

YOU MAY NEED (NOT SUPPLY)

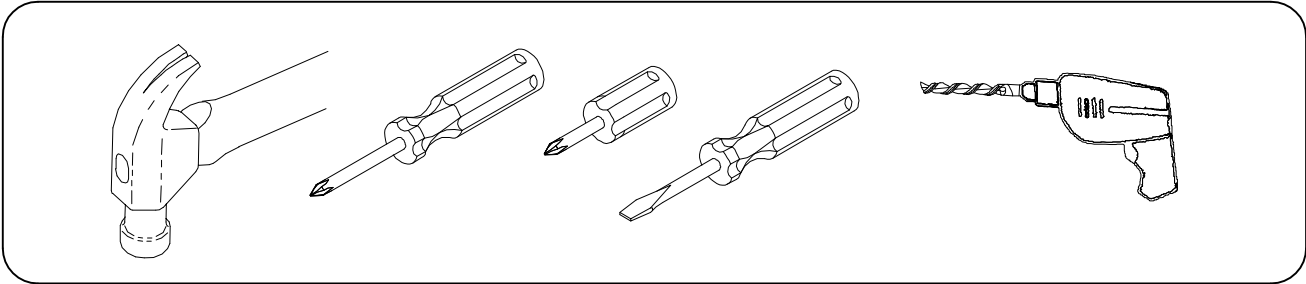



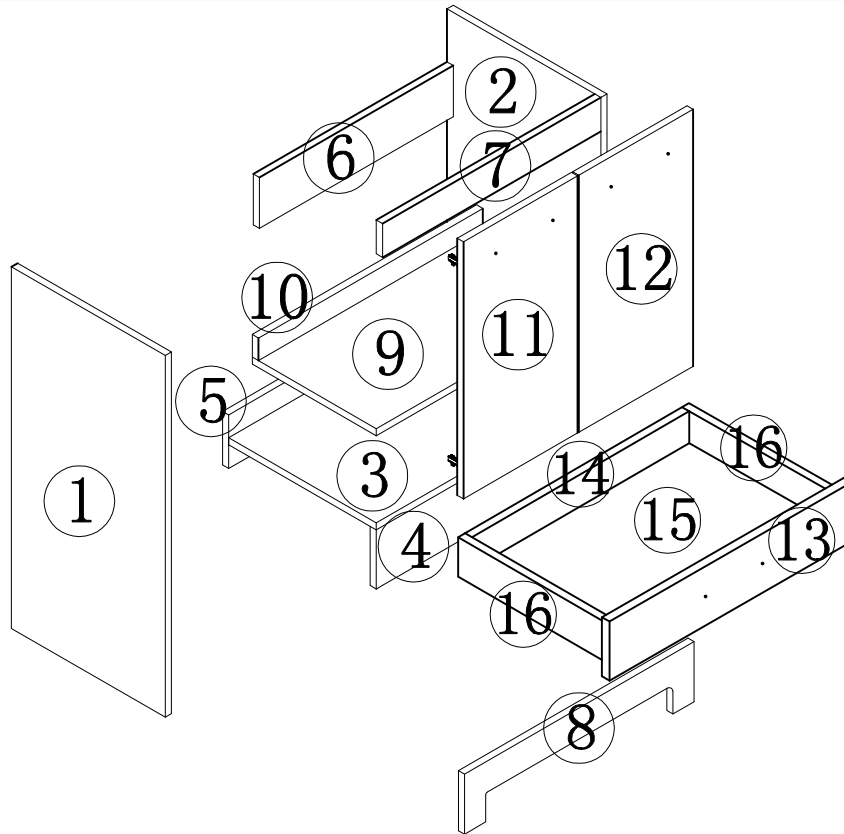





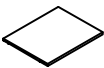

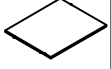

ASSEMBLY DIAGRAM





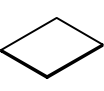







PARTS LIST

PARTS LIST

NO	DESCRIPTION	QTY	NO	DESCRIPTION	QTY
①	Left side panel 	1	⑨	laminate 	1
②	Right side panel 	1	⑩	rear drop down 	1
③	Bottom panel 	1	⑪	Left door panel 	1
④	Bottom inside front panel 	1	⑫	The right door 	1
⑤	rear drop down 	1	⑬	drawer panel 	1
⑥	Upper back panel 	1	⑭	drawer back panel 	1
⑦	Long front panel 	1	⑮	drawer bottom 	1
⑧	Bottom outside front panel 	1	⑯	drawer panel 	2

PARTS LIST

HARDWARE LIST

NO	DESCRIPTION	QTY	NO	DESCRIPTION	QTY
A	Three-in-one eccentric wheel 	38	G	4*23mm screw 	6
B	Three-in-one connecting rod 	38	H	Door Handle 	2
C	Three-in-one sticker 	38	I	Drawer handle 	1
D	8*40mm wood dowel pins 	12	J	Drawer slides 	2
E	Door hinge 	4			
F	4*16mm screw 	36			

CAUTION:

Please confirm the parts list before installation

STEP 1

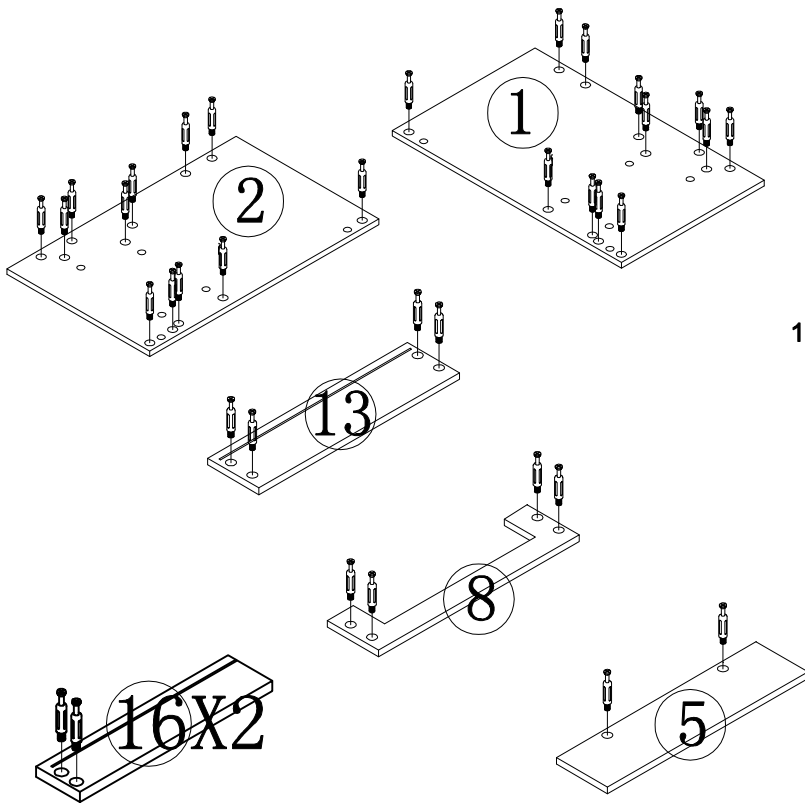

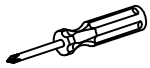
HARDWARE LIST	
Three-in-one connecting rod B  38 PCS	

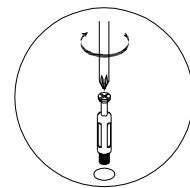

1. Put the three-in-one connecting rod in the $\varnothing 10\text{mm}$ hole of the following panels and tighten them with a cross screwdriver or an electric tool.

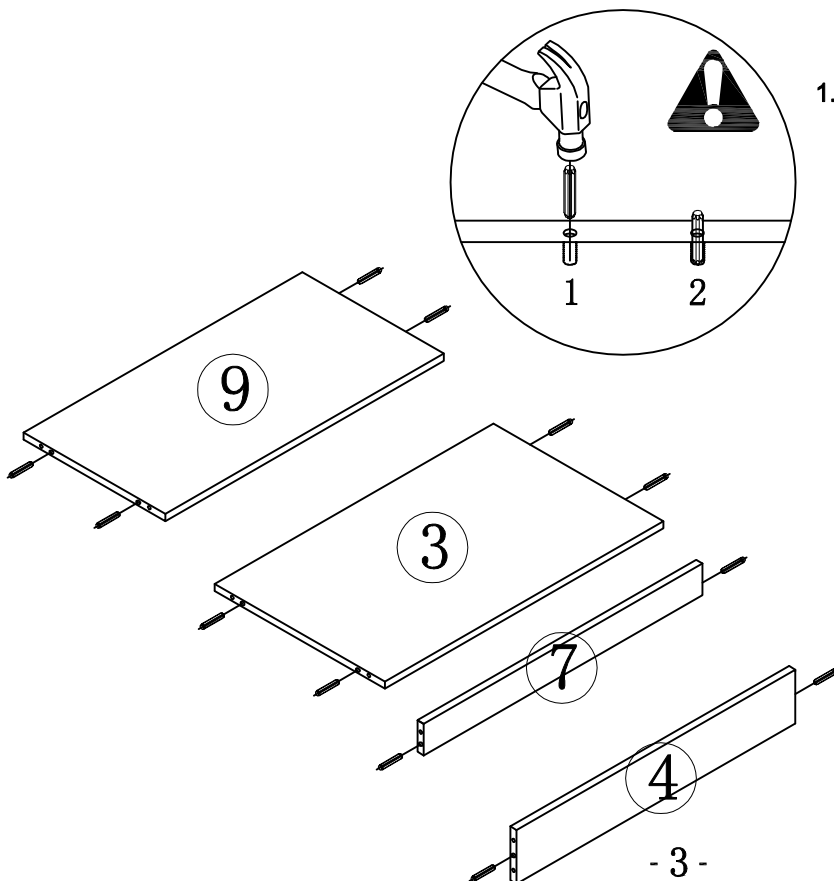

STEP 2



1. Strike the $\varnothing 8 \times 40\text{mm}$ wood dowel pin into the $\varnothing 8\text{mm}$ hole of the above panels with an iron hammer. Please note that the hole of the three-in-one connecting rod should also be 8mm. The hole of the three-in-one connecting rod connects to the hole of $\varnothing 15\text{mm}$ three-in-one eccentric wheel.

HARDWARE LIST	
8*40mm wood dowel pins D  12 PCS	

STEP 3

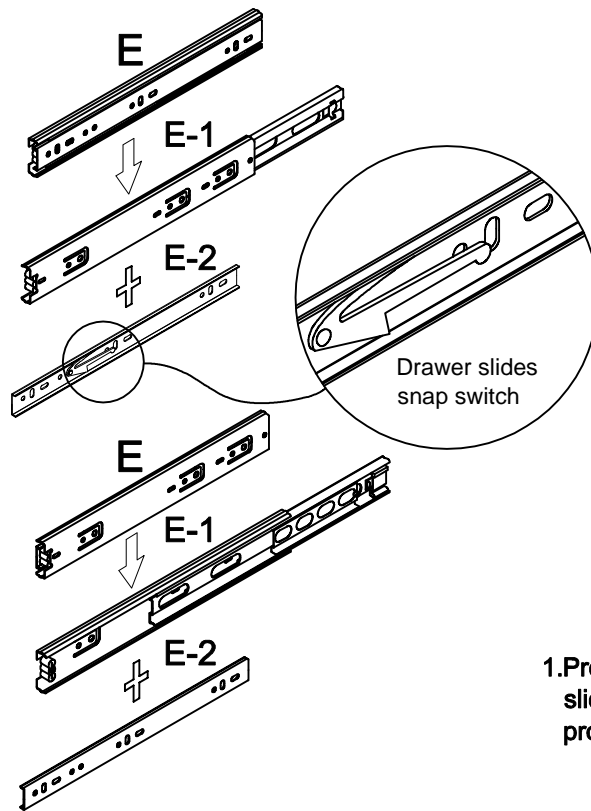

HARDWARE LIST	
Drawer slides	
J 2PCS	

1. Press the side snap switch, disassemble slide blocks and put them in a place properly for further use.

STEP 4

1. Fix the drawer slide to the side panel with 4*16mm screws.

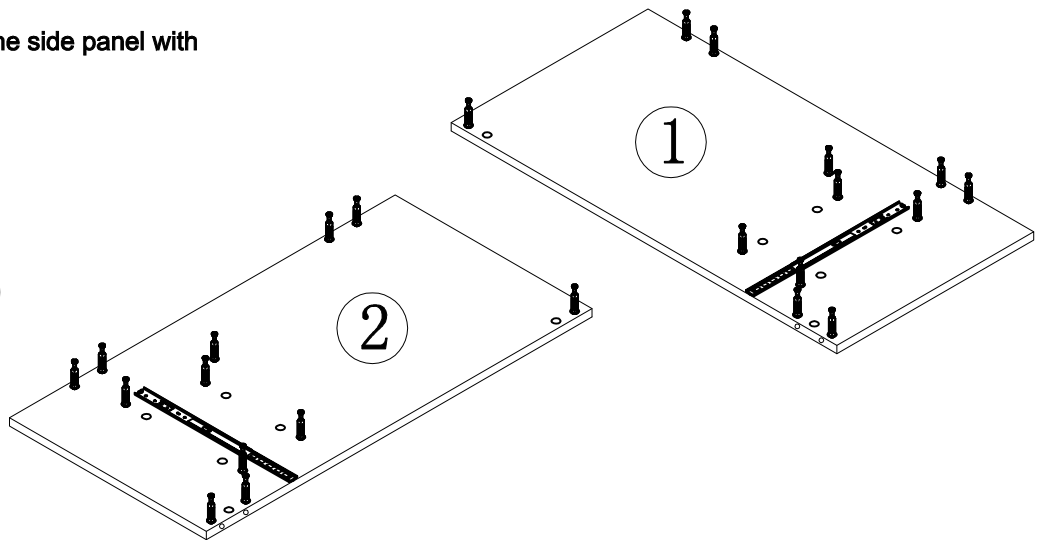
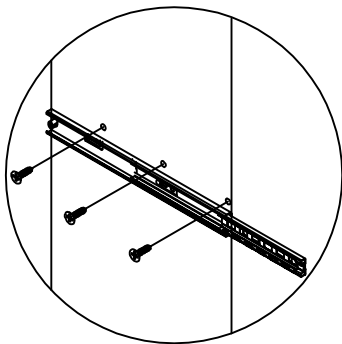

HARDWARE LIST		
4*16mm screw	Drawer slides	
F 6PCS	J-1 2PCS	

STEP 5

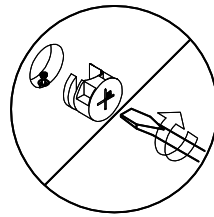
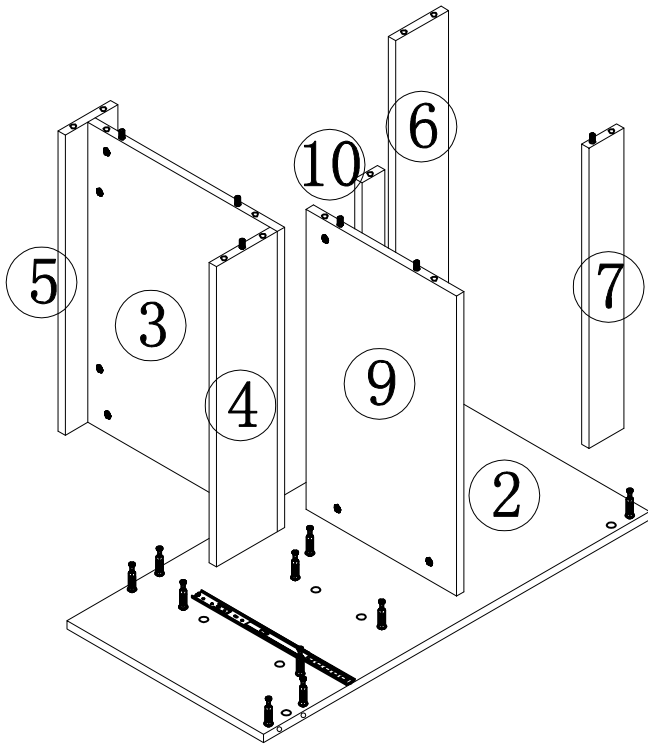

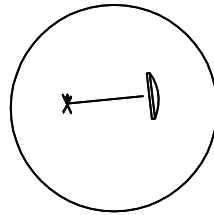

1. Connect No. 3-4-5-6-7 panel to No.2 panel tightly with the three-in-one eccentric wheel.



2. Cover the mounting hole of the eccentric wheel with a three-in-one sticker.

HARDWARE LIST

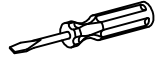
Three-in-one eccentric wheel A  12 PCS	Three-in-one sticker C  12 PCS	
--	--	---

STEP 6

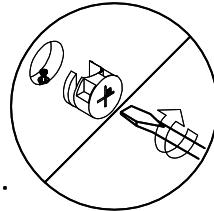
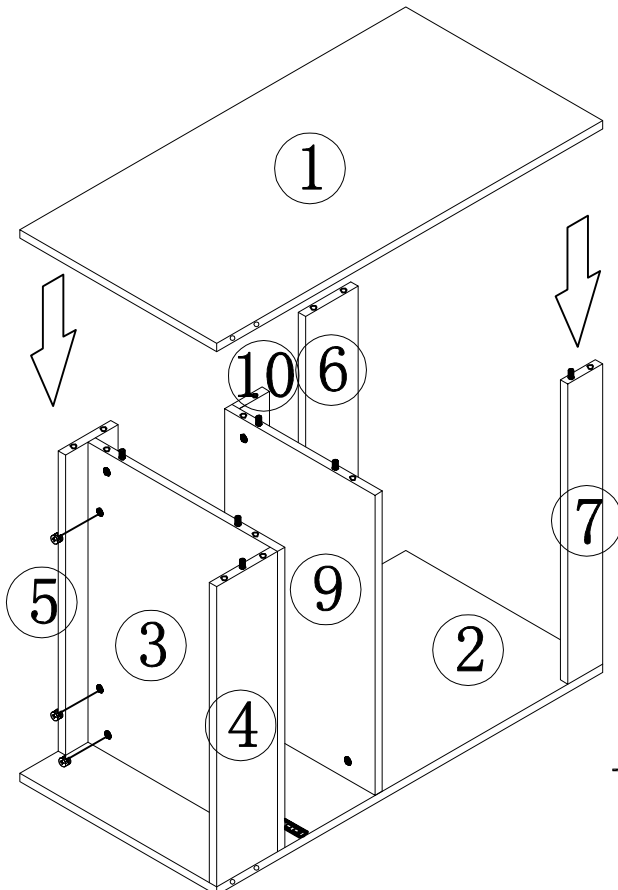

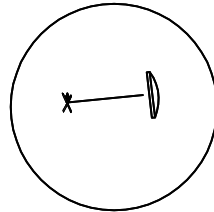

1. Connect No. 3-4-5-6-7 panel to No.2 panel tightly with the three-in-one eccentric wheel.



2. Cover the mounting hole of the eccentric wheel with a three-in-one sticker.

HARDWARE LIST

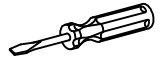
Three-in-one eccentric wheel A  12 PCS	Three-in-one sticker C  12 PCS	
--	--	---

STEP 7

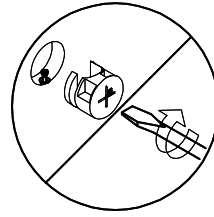
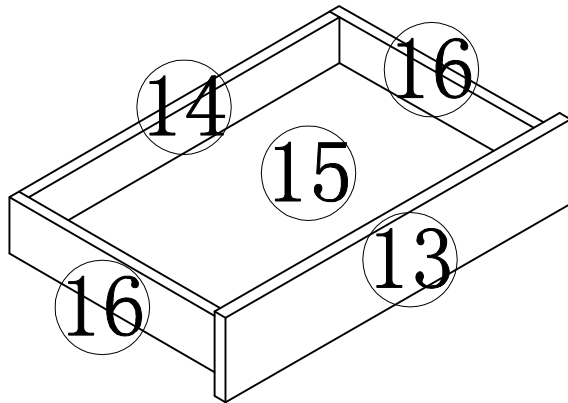
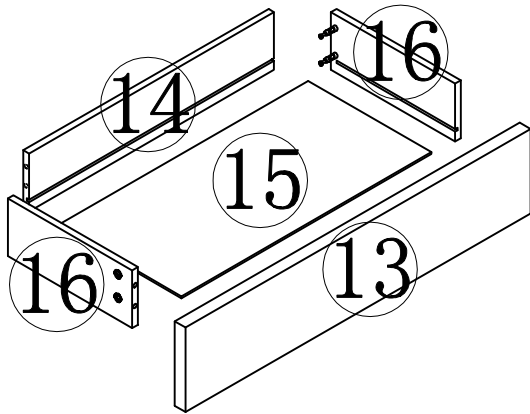

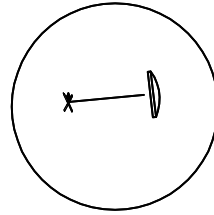

1. Install No. 10-11-12-13 panels with the three-in-one eccentric wheel tightly.



2. Cover the mounting hole of the eccentric wheel with a three-in-one sticker.

HARDWARE LIST

Three-in-one eccentric wheel A  8PCS	Three-in-one sticker C  8PCS	
--	--	--



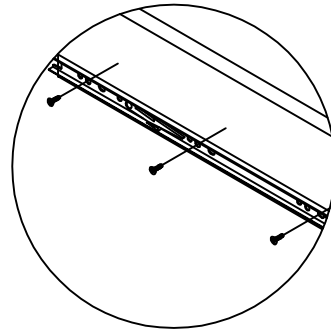
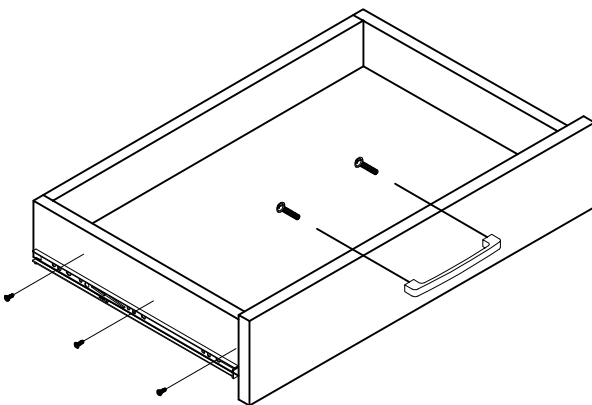

STEP 8



1. Lock the spare drawer slide block to the drawer.

2. Install the drawer handle with 4*23 handle screws.

HARDWARE LIST

4*16mm screw F  6PCS	Drawer slides J-2  2PCS	
4*23mm screw G  2PCS	Drawer handle I  1PCS	

STEP 9

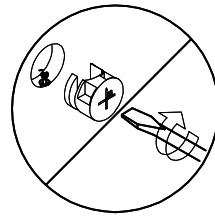
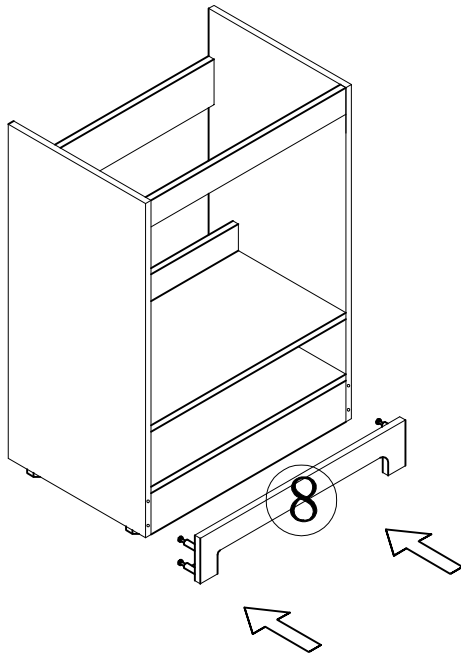

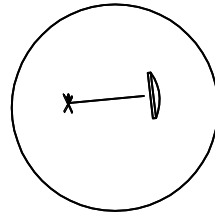

1. Install No.6 panels with the three-in-one eccentric wheel tightly.



2. Cover the mounting hole of the eccentric wheel with a three-in-one sticker.

HARDWARE LIST

Three-in-one eccentric wheel A  4PCS	Three-in-one sticker C  4PCS	
--	--	--

STEP 10

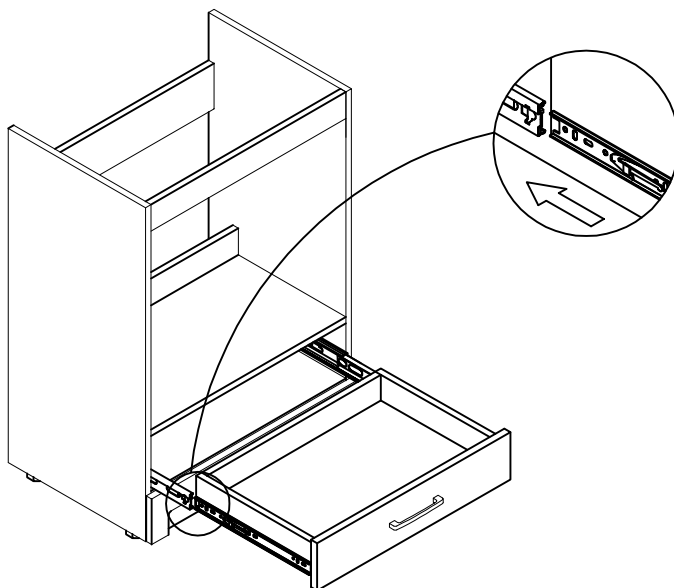

1. Align side block with the trough on the guide rail, press the snap switch and press it forward to install the drawer.

2. Install drawer handles.

STEP 9

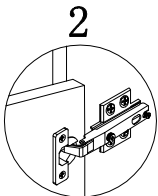
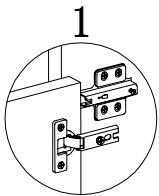
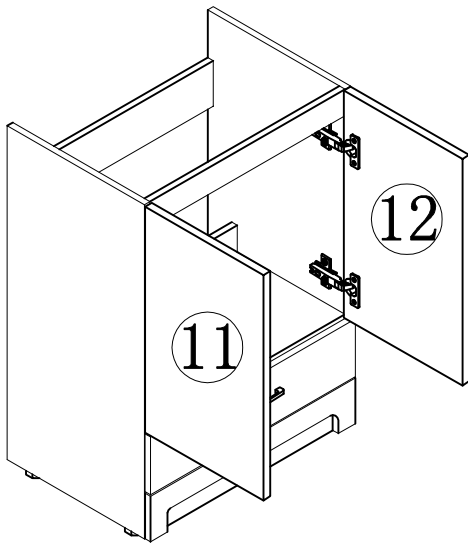

3. Install the hinge cup on the door panel to the hinge of the side panel.

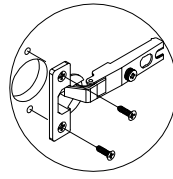

1. Install the hinge cup to the door panel with 4*16mm screws.

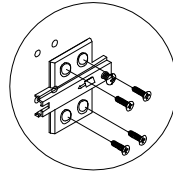

2. Install the hinge to the side panel with 4*16mm screws.

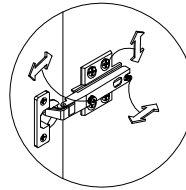

4. Adjust the door panel clearance.

HARDWARE LIST

4*16mm screw	Door hinge	
F  24PCS	K  4PCS	

STEP 10

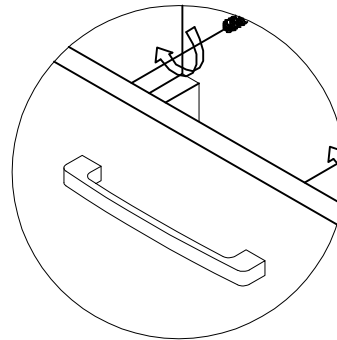
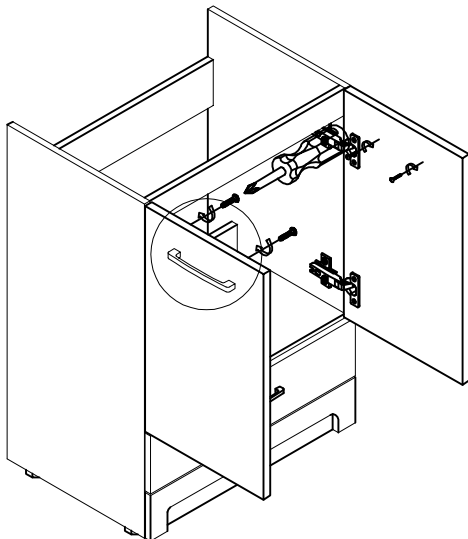

Install the door handle with 4*23mm handle screws.

HARDWARE LIST

4*23mm screw	Door handle	
G  4PCS	H  2PCS	



Choking hazard-Small Parts : This unit contains small parts, not for children under 3 years.

Tip-over hazard : Secure finished unit to wall stud using L-Bracket and wall screw (#10*1.5"W/out provided). If a wall stud is not neccessible , Consault your local hardware store for appropriate mounting hardware . Failure to properly install will result in product collapse or tip-over. Serious injury can occur .