

# AI Bird Feeder Quick Guide

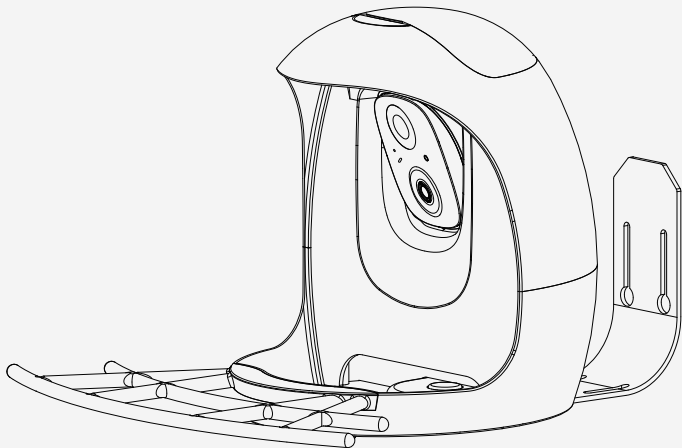

# Warning

**Note:** This equipment has been tested and found to comply with the limits for a Class B digital device, pursuant to part 15 of the FCC Rules. These limits are designed to provide reasonable protection against harmful interference in a residential installation.

This equipment generates uses and can radiate radiofrequency energy and, if not installed and used in accordance with the instructions, may cause harmful interference to radio communications. However, there is no guarantee that interference will not occur in a particular installation.

If this equipment does cause harmful interference to radio or television reception, which can be determined by turning the equipment off and on, the user is encouraged to try to correct the interference by one or more of the following measures:

- Reorient or relocate the receiving antenna.
  - Increase the separation between the equipment and receiver.
  - Connect the equipment into an outlet on a circuit different from that to which the receiver is connected. Consult the dealer or an experienced radio/TV technician for help.
- The antennas used for this transmitter must be installed to provide a separation distance of at least 20 cm from all persons and must not be co-located for operating in conjunction with any other antenna or transmitter.

FCC(USA) 15.9 prohibition against eavesdropping except for the operations of law enforcement officers conducted under lawful authority, no person shall use, either directly or indirectly, a device operated pursuant to the provision of this part for the purpose of overhearing or recording the private conversations of other unless such use is authorized by all of the parties engaging in the conversation. Changes or modifications not expressly approved by the party responsible for compliance could void the user's authority to operate the equipment.

## FCCID: 2AY58-V6-WNQ02

ICCaution:

- English:

This device contains licence-exempt transmitter(s)/receiver(s) that comply with Innovation, Science and Economic Development Canada's licence-exempt RSS(s). Operation is subject to the following two conditions:

This device may not cause interference.

This device must accept any interference, including interference that may cause undesired operation of the device.

This product can be used across EU member states.

# What's in the Box

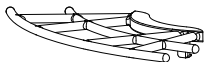

Perch

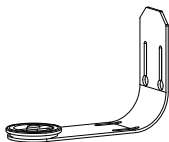

Mounting Bracket

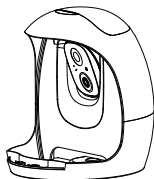

Bird Feeder



Black Strap



Drilling Template



Hose Clips\*2



Quick Guide

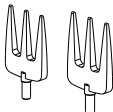

Fruit Fork \*2

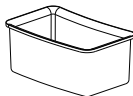

Water Box



Ejector Pin

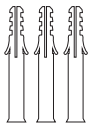

Anchors\*3

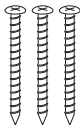

Mounting Screws\*3



Mounting Screws\*3

## Optinal accessories

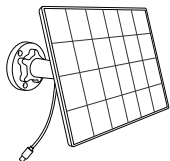

Solar Panel

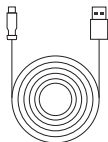

Charging Cable



Coolfly CoolBirdie Toy

# Camera Structure

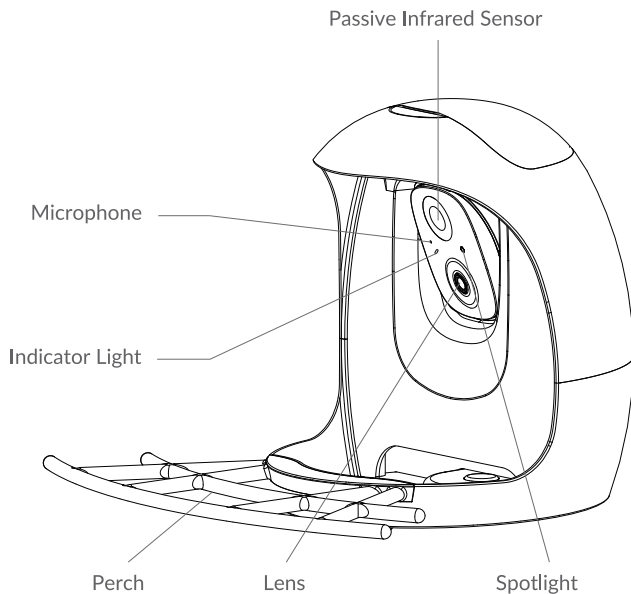

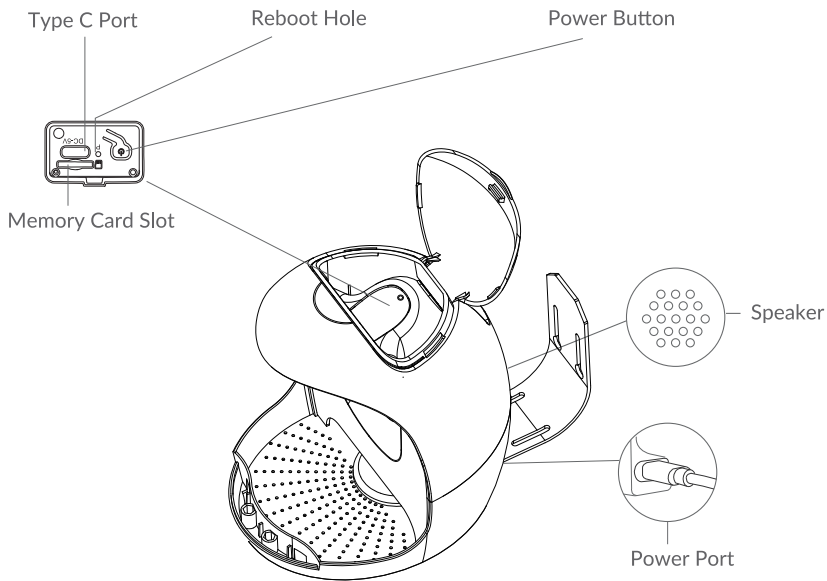

## Assemble Bird Feeder

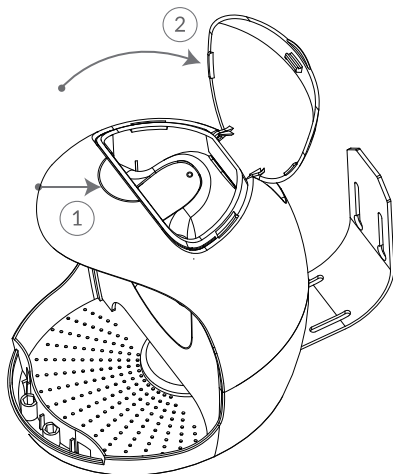

### Open the Bird Feeder

Step 1: Put your fingers in the clasp position and gently press up wards.

Step 2: Open the top cover upwards, you can add birdseed or turn on camera.

## Assemble Perch

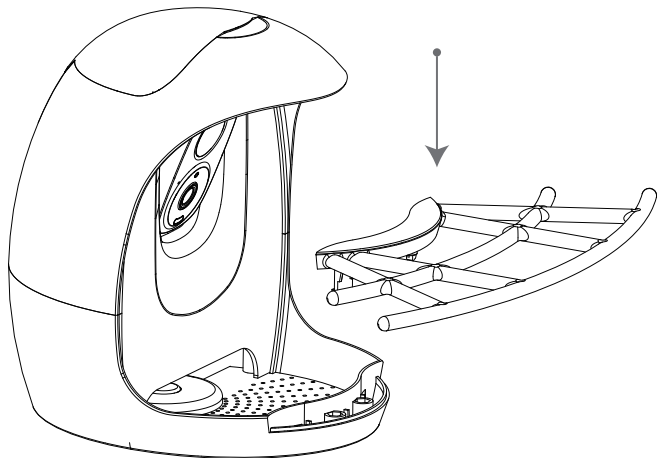

Fixed the perch downwards in good position.

## Camera Charging

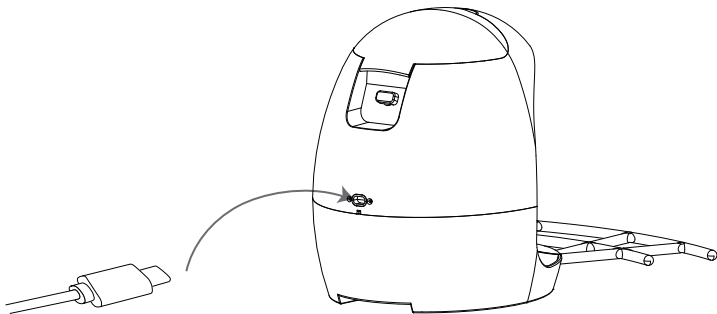

The batteries inside the camera are not fully charged according to the transportation safety regulations. Please fully charge the camera before using it. Please charge the batteries with Type C Port Cable. (DC5V/ 1.5A adapter not included).

The LED Indicator will be in solid yellow when charging and will turn to solid green when it is fully charged. It takes about 8-10 hours to fully charge your camera.

## How to Turn on & off the Camera

To turn on the camera:

Press the Power Button on the top of the camera to turn it on.  
Then the LED Indicator in the left of the camera will be blink blue.

Recommended brands include SanDisk and SAMSUNG. Use an Memory Card with a capacity of no more than 128GB, a minimum speed of Class 10, and formatted in FAT32.

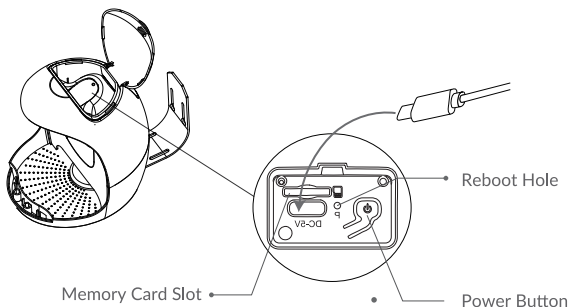

To turnoff the camera:

Press the power button on the top of the camera to turn it off.  
Then the LED Indicator in the left of the camera will be off.

# Set up with App

Download App.

## Connection Camera

1. Open the app, go to the bird feeder interface, and tap "Add New Device."
2. Choose the type of device you want to add.

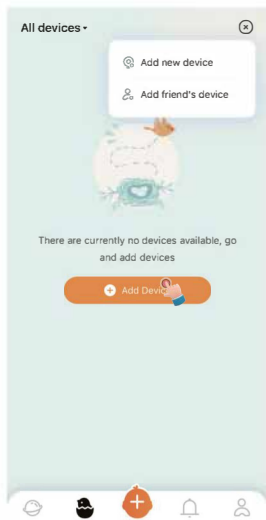

3. Press and hold the power button. When you hear a beep and see the indicator lights flash, the device is ready to pair. Tap "Next."(If the camera is already on, double-click the power button to switch to pairing mode.)

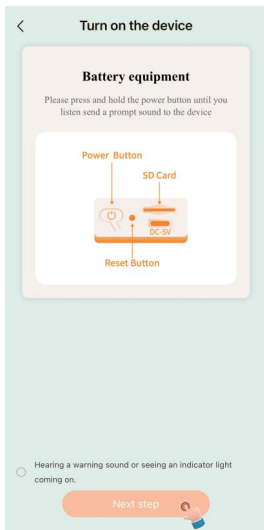

4. Wait while Bluetooth scans for nearby devices.

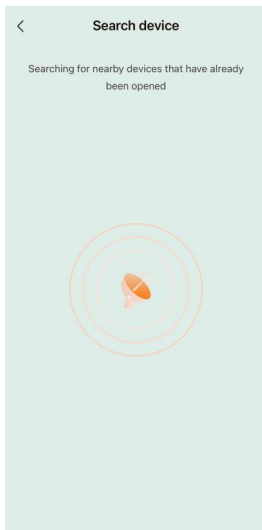

5. Select your device from the list and tap "Next."

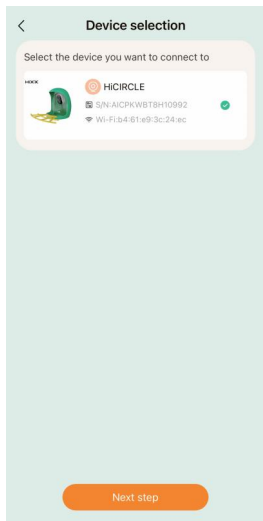

6. Choose your Wi-Fi network and enter the password.

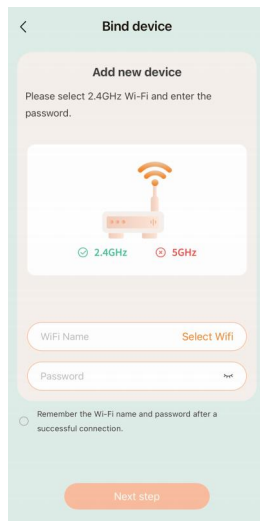

7. Coolfly will connect to the device.  
Tap "Connect."

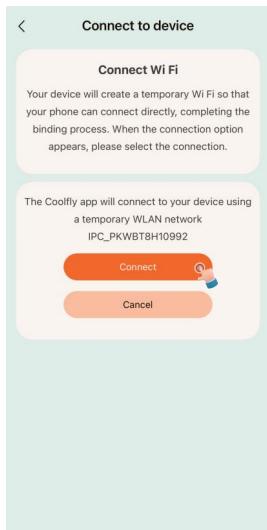

8. Name your device and tap "Complete"  
to finish the setup.

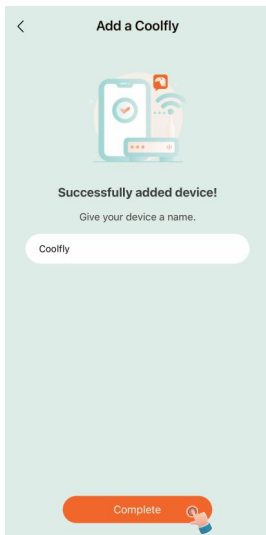

## Read before Installation

1. Keep Bird Feeder and all accessories out of reach of children and pets.
2. Make sure the camera has been fully charged (DC5V / 1.5A).
3. Working temperature: -10°C to 50°C (14°F to 122°F)  
Working relative humidity: 0-90%
4. Please do not expose the camera lens to direct sunlight.

### Note:

1. Bird Feeder Cam only works with 2.4GHz Wi-Fi.
2. Strong lights may interfere with the device's ability to scan QR code.
3. Avoid placing the device behind furniture or near microwave products.  
Try to keep it within range of your Wi-Fi signal.

## Bird Feeder Installation

Check the following things before you drill holes on your wall:  
Bird Feeder Cam has been successfully added to your APP and is able to stream video.

## Wall Installation:

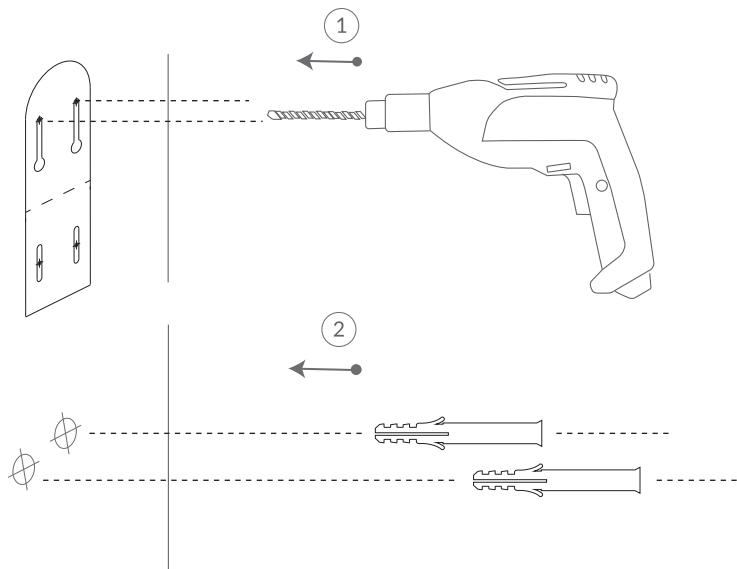

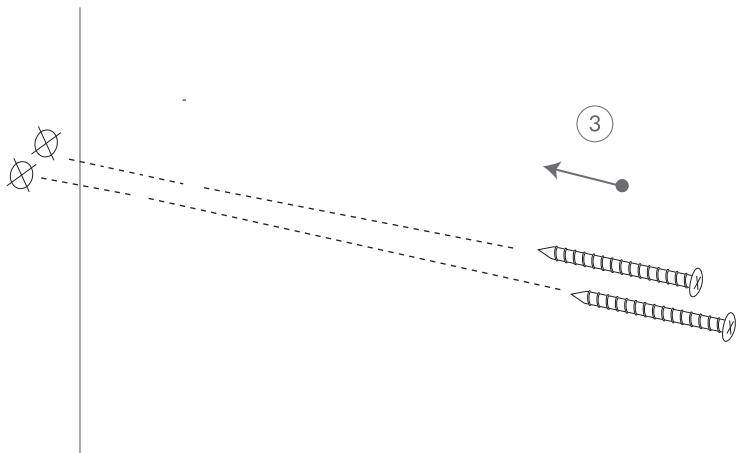

### Step 1:

1. Use the provided drilling template to mark the position of holes on your wall. Use drill bit (15/64", 6mm) to drill two holes.
2. Install the anchors to fix the screws. (Install on wood skip this step.)
3. Install the Mounting Bracket on your wall with the screws provided.

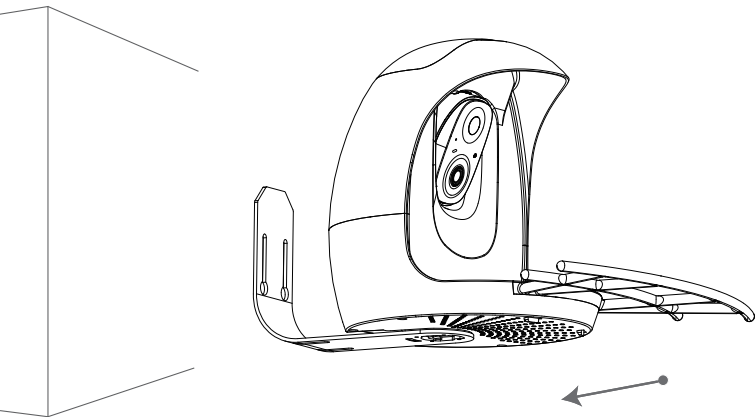

**Step 2:**

Slide the Bird Feeder into the bracket through the slide rail.

## Tree Installation:

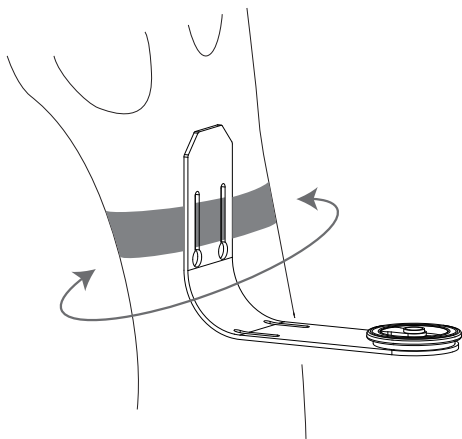

### Step 1:

Wrap the Mounting Bracket around the tree with the Black Strap.

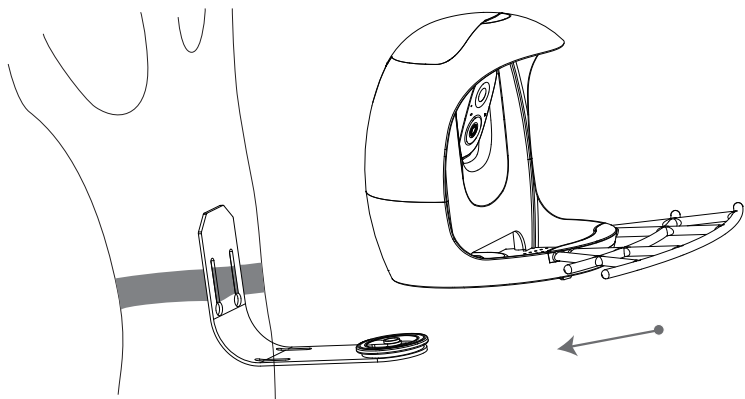

**Step 2:**

Slide the Bird Feeder into the mounting bracket.

## Stand Installation:

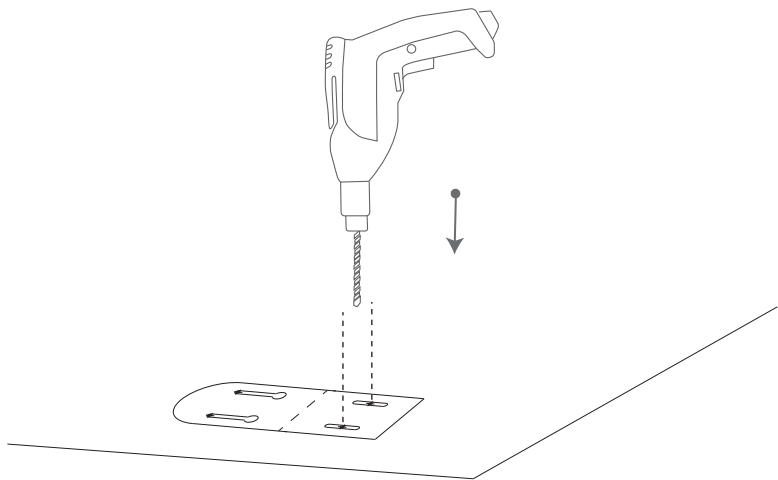

### Step 1:

The Bird Feeder can be placed steadily on a flat surface, but for stability, we recommend that the backplane is installed and fixed on a flat surface.

Use the provided drilling template to mark the position of holes on the flat surface. Use a drill bit ( $5/16"$ , 8mm) to drill two holes.

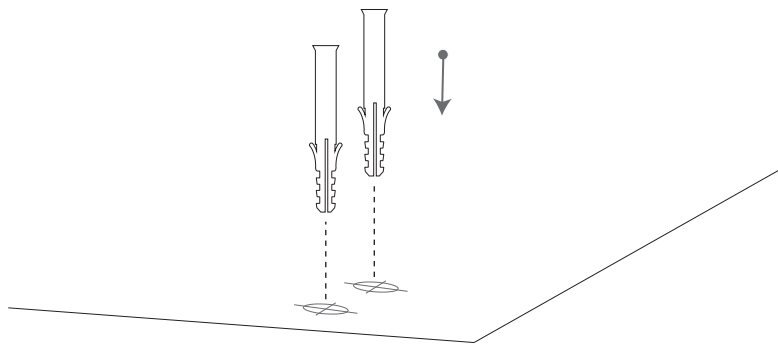

**Step 2:**

Install the anchors to fix the screws. (Install on wood skip this step.)

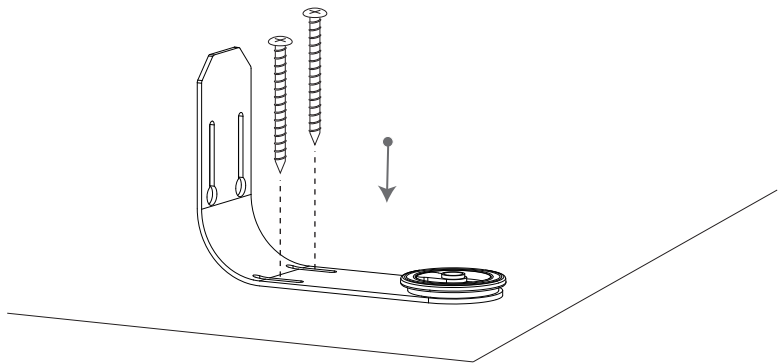

**Step 3:**

Install the Mounting Bracket on flat surface with the screws provided.

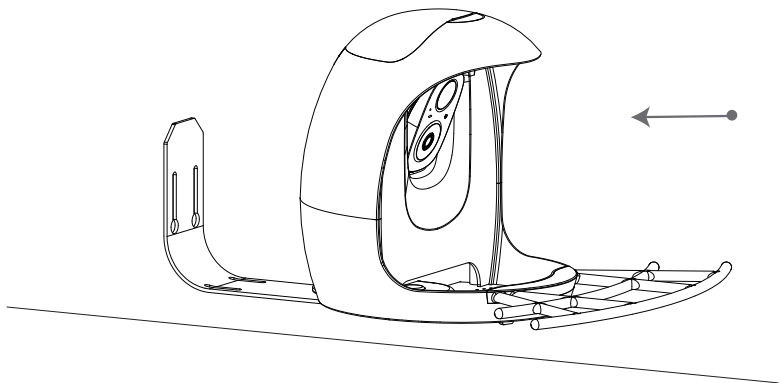

**Step 4:**

Slide the Bird Feeder into the mounting bracket.

## Solar Panel Installation

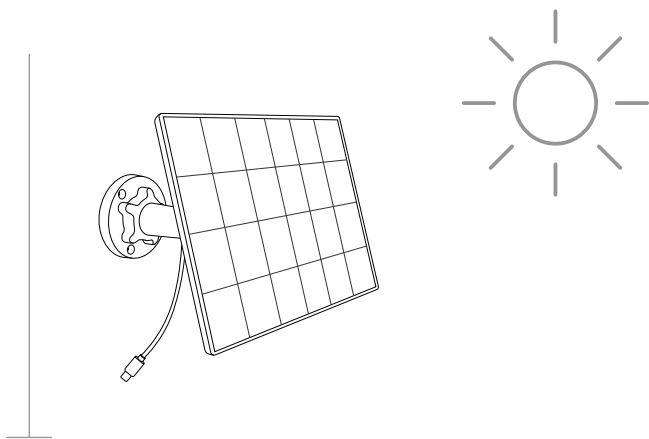

### Step 1:

Please confirm that the purchased version includes the solar panel. If not included, please purchase it separately

### Step 2:

Find a good installation point and install the Solar Panel in a sunny location.

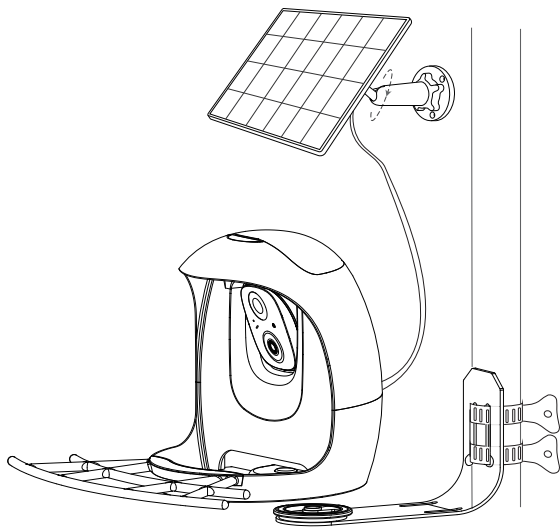

**Step 3:**

After Bird Feeder is installed and ready for bird watching. Connect Solar Panel cable to Bird feeder charge port.

# Cleaning Bird Feeder

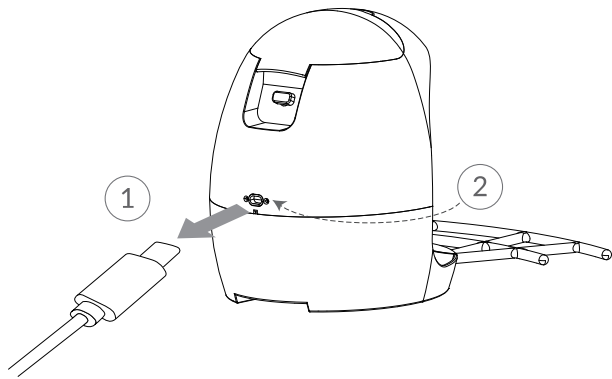

**Step 1:**  
Unplug the charging cable and put on the silicone cover.

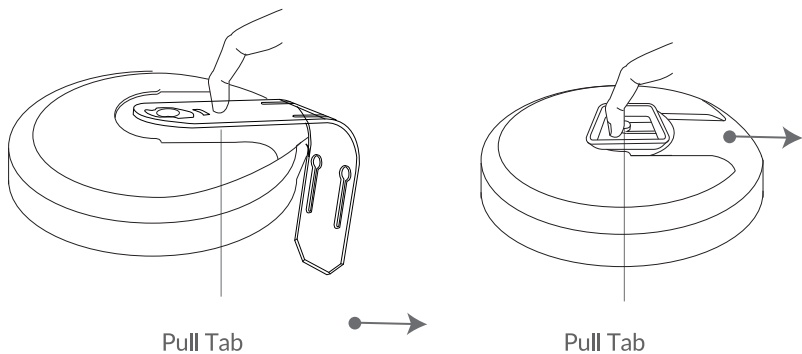

**Step 2:**

Using the Pull Tab on the base of the feeder, remove the Bird Feeder from the bracket.

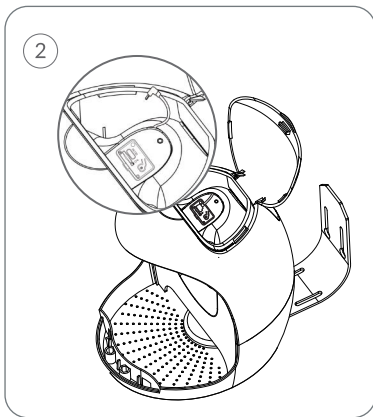
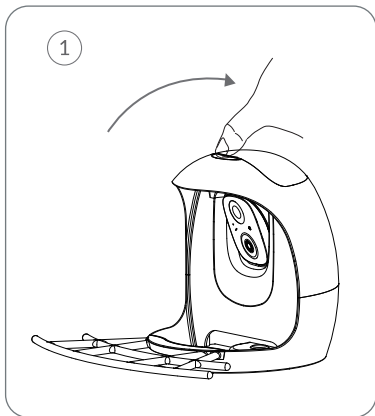

**Step 3:**

Put your fingers in the clasp position and gently press upwards.  
Open the top cover upwards. Unplug the camera's charging cable.

3

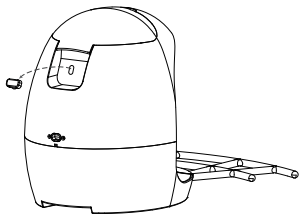

4

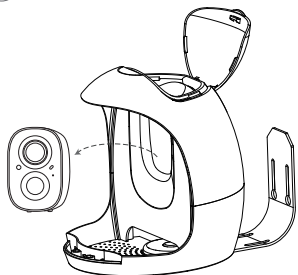

**Step 4:**

Remove the camera's mounting screws and then take out the camera.

5

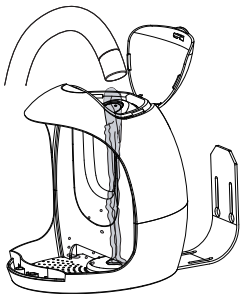

6

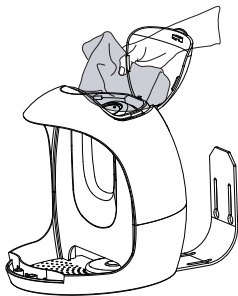

**Step 5:**

Pour water on both sides of the seed reservoir.

Wash it carefully. Dry the feeder, including the seed reservoir.

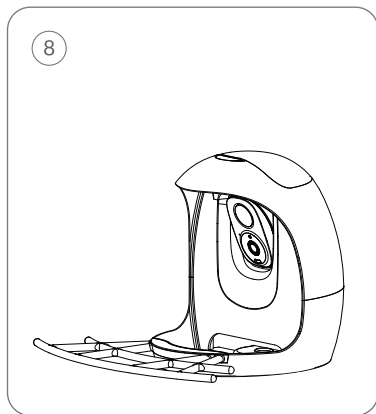
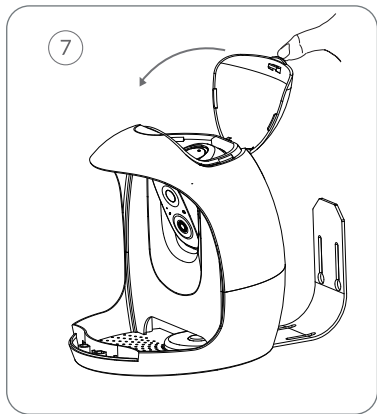

**Step 6:**  
Cover the Roof: Pull the cover back in good position with buckle.

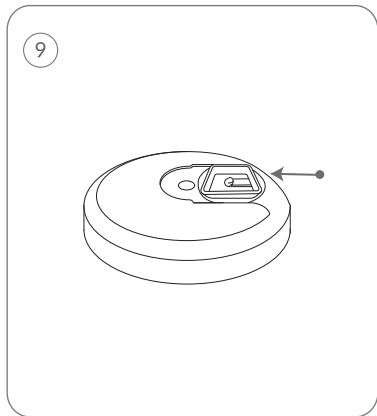
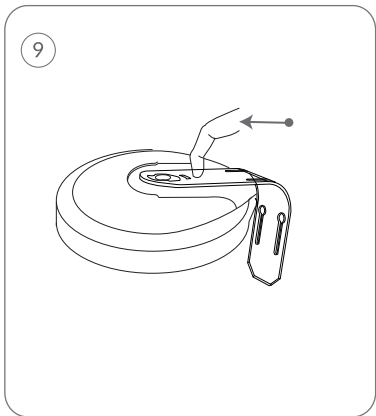

**Step 7:**  
Re-attach the bracket to the Bird Feeder base.

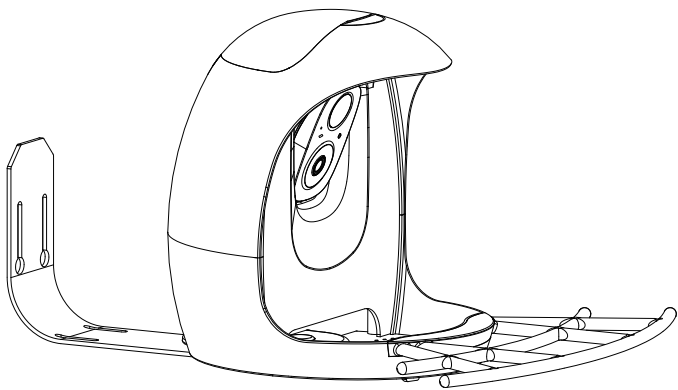

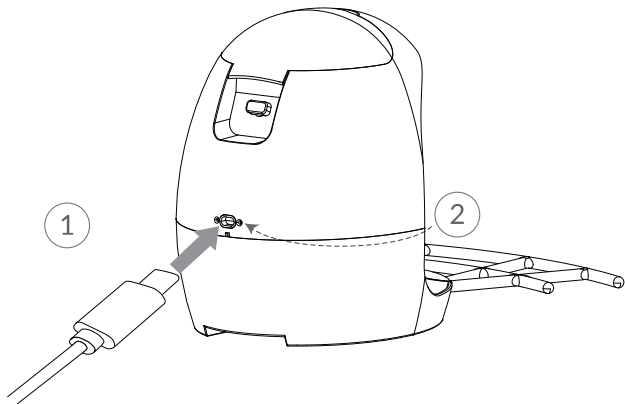

**Step 8:**  
Open the silicone plug, replugin in the Solar Panel.

## How to Add Bird Seed

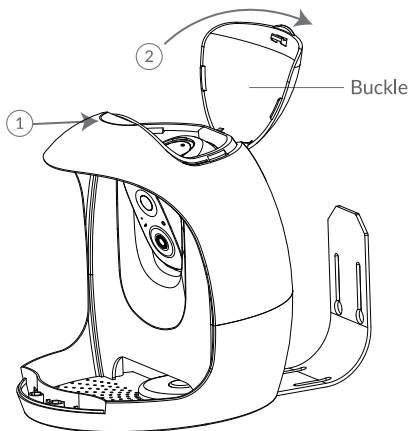

### Step 1:

Open the buckle on the top of the Bird Feeder, and pull up on the roof to open.

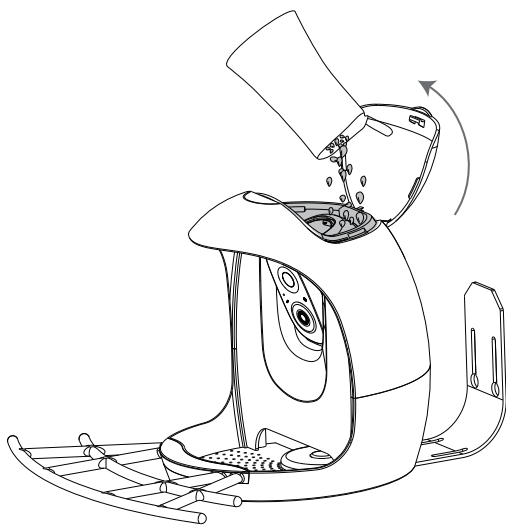

Step 2:  
You can add bird seed. Finally, close the roof back.

## Status Light

This camera uses status light to communicate.

LED Indicator	Description
Solid Blue	Working
None	Sleep/Power Off
Solid Yellow	Charging
Solid Green	Charging Finished

## Camera Reset

When the Camera is powered on, if you are not hear a prompt sound of "Ding,Ding,Ding,Ding", please quickly press power button twice in a row, until the blue light flashes, and a prompt sound of "Ding,Ding, Ding,Ding", that is,the reset is successful.

# Frequently Asked Questions

**Q1: Why doesn't the Wi-Fi name appear when I connect to Wi-Fi?**

A1: You need to turn on the "location permission" for the app in the system settings and change it to "allow when using".

**Q2: Will the camera show red lights when night vision is activated?**

A2: The built-in infrared lamp beads make the camera only show some dim red lights when night vision is activated, but the image quality is still clear under no light environment.

**Q3: What are the requirements for Wi-Fi?**

A3: Please use a 2.4GHz wireless network. The device does not support the 5GHz wireless network. Meanwhile, please set the Wi-Fi authentication method to wpa2-psk or other lower level of the security method. A password is required.

**Q4: How far should the camera be placed from the router?**

A4: After testing, the Wi-Fi connection distance can normally reach up to 100 meters in the open area. However, the actual situation depends on the strength of Wi-Fi and its surrounding environment.

**Q5: What is the maximum length of recording time?**

A5: You can choose the recording time in the app. The camera record for a fixed time or "auto" mode, when depending on whether there is a person, the maximum length of a video is 30 seconds.

**Q6: What should I do when the device is malfunctioning?**

A6: Long press the power button to restart the camera.