

# ASSEMBLY INSTRUCTIONS

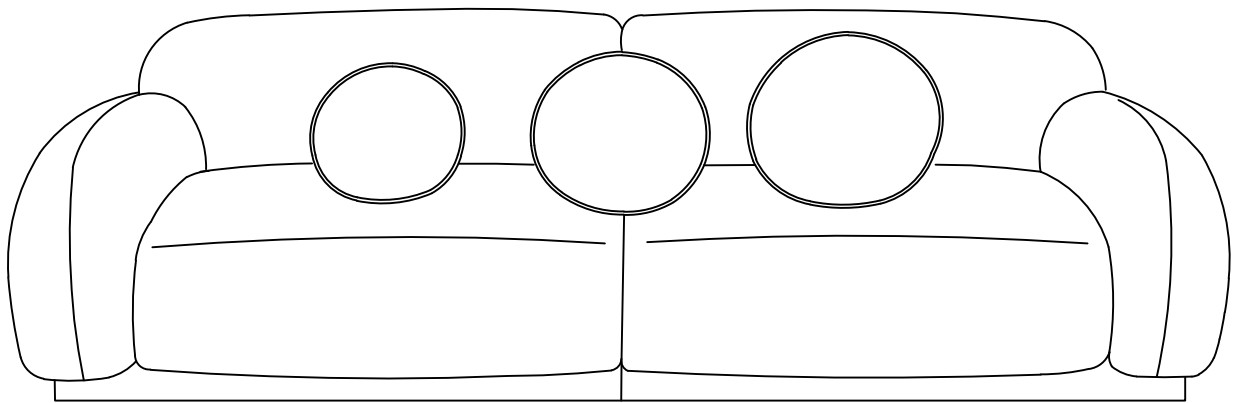

SOFA

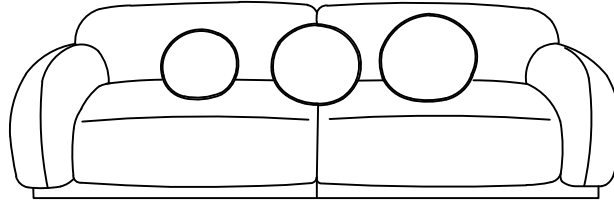

# ASSEMBLY INSTRUCTIONS

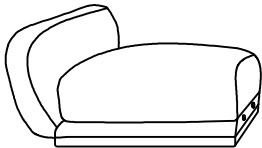
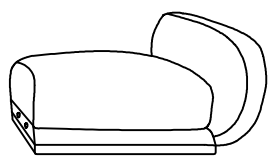
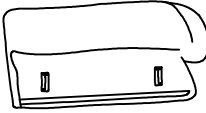
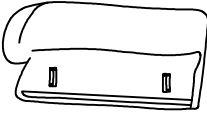

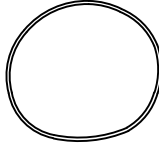
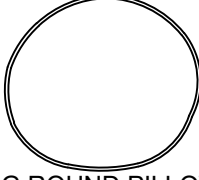
PART LIST		
No.	Sketch	Q'ty
A	 LEFT SEAT FRAME	1 PC
B	 RIGHT SEAT FRAME	1 PC
C	 RIGHT BACKREST	1 PC
D	 LEFT BACKREST	1 PC

PART LIST			
No.	Sketch	Q'ty	
E	 SMALL ROUND PILLOWS	2 PC	
F	 BIG ROUND PILLOWS	1 PC	
HARDWARE LIST			
No.	Description	Sketch	Q'ty
G	Connecting Bolt		2 PCS

**Step 1:**

Remove all cushions and backrests packed with the seat frames before assembly.

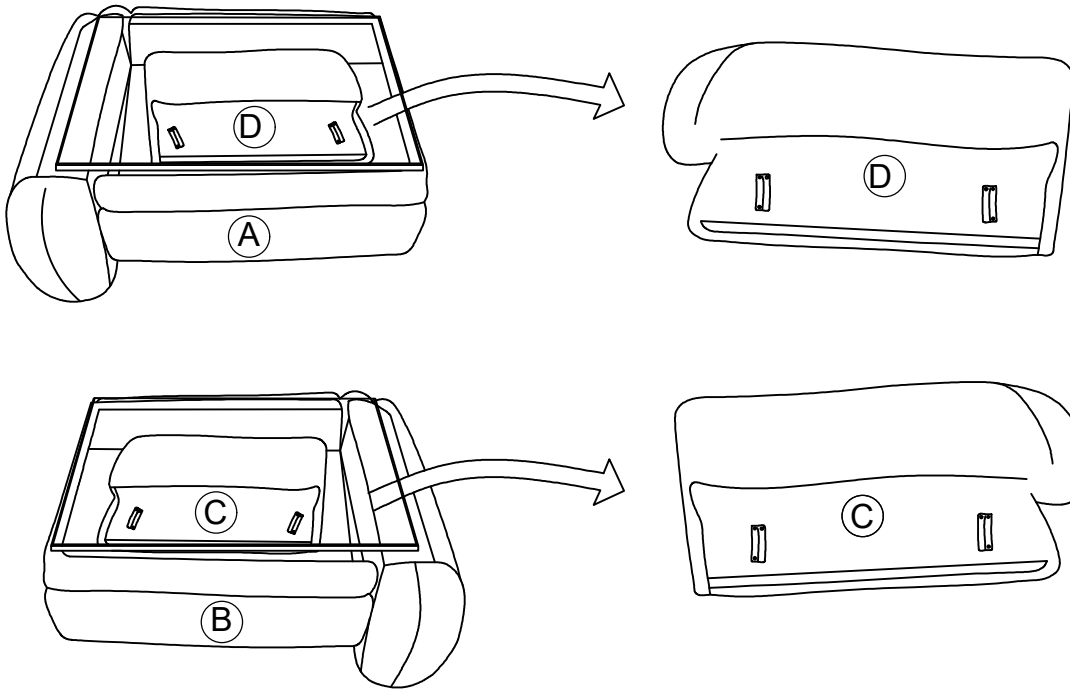

**Step 2:**

Flip the seat frame over to access the installation points for the backrest. Align the metal bracket on the backrest with the corresponding bracket on the seat frame, then slide it into place until fully seated and secure.

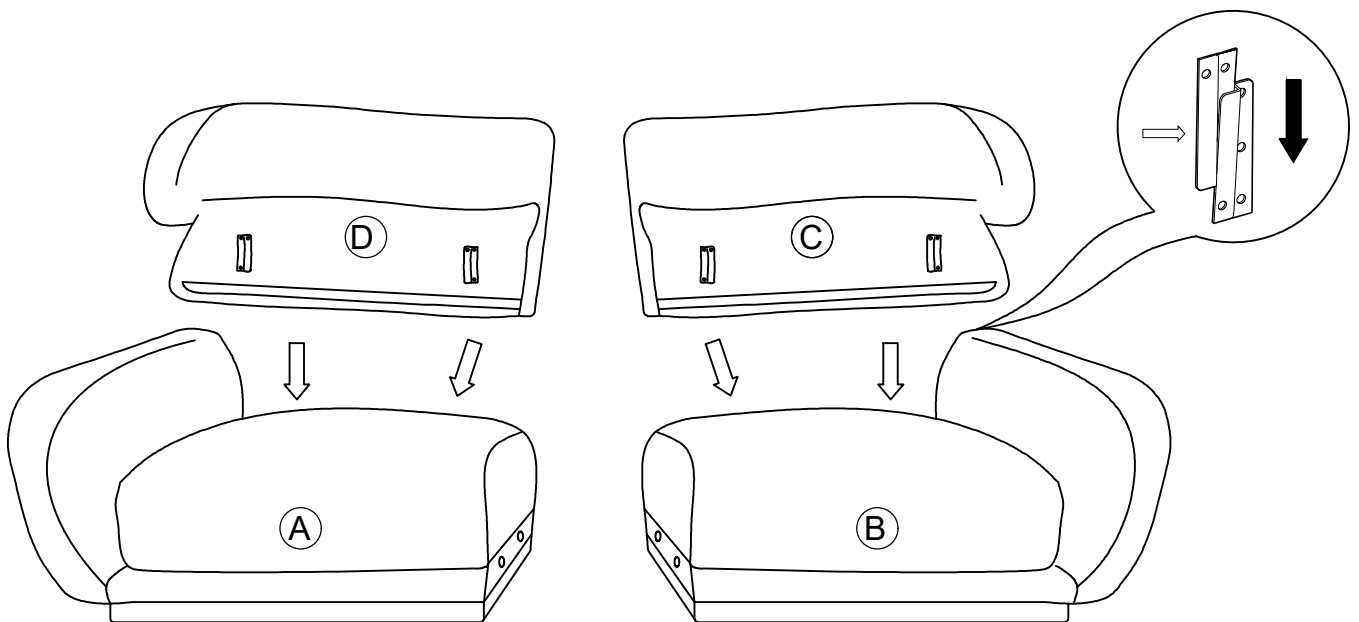

**Step 3:** Secure the connection by tightening the bolts (G) as shown in the illustration below. To assembling Left Arm Facing sofa and Right Arm Facing sofa. Ensure all screws are tightened firmly.

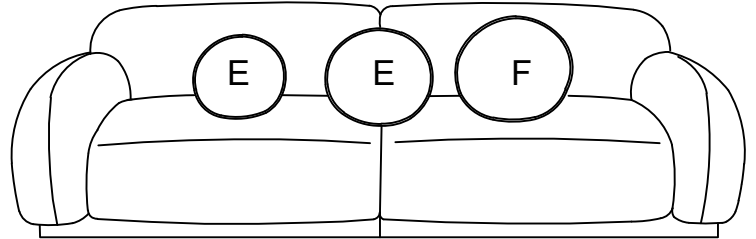
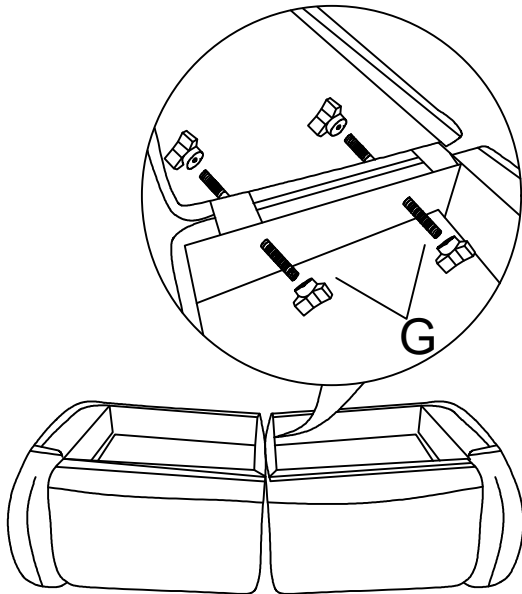

## ASSEMBLY INSTRUCTIONS

### ASSEMBLY TIPS

1. Remove hardware from box and sort by size.
2. Please check to see that all hardware and parts present prior to start of assembly.
3. Please follow attached instruction in the same sequence as numbered to assure fast & easy assembly.

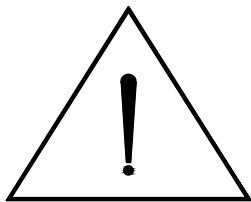

## WARNING !

Do not attempt to repair or modify damaged or defective parts. Please contact the store immediately or our customer service.

**ASSEMBLY TIME : 15-30 MINUTES**

