

Assembly Instruction

Dekka Outdoor Coffee Table

Your furniture requires assembly prior to use. It is important that you read the entire assembly instructions to become familiar with the unit before you set up this product.

Safety Warning and Precautions

WARNING: When setting up your furniture, basic precautions should always be followed to reduce risk of personal injury and damage to the product.

Read all instructions before assembly and usage this product.

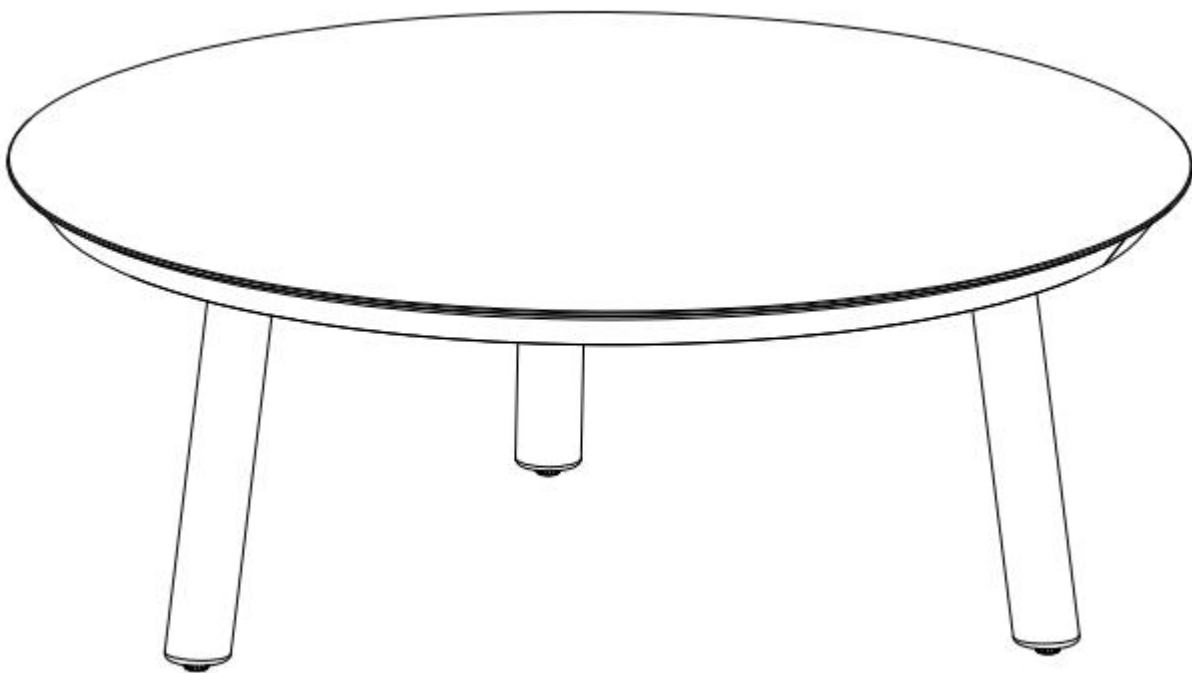

1. Select ideal location. Set out all parts on a clear and level surface prior to assembly. Ideally, the furniture should be set up in the desired location to avoid moving it after assembly.
2. Use caution. During all the processes of assembling, especially when lifting heavy or large parts, pay attention to safety.
3. Tools and Assistance. An adjustable spanner is required for assembly. It is recommended 2 people assist with assembly.
4. Check all parts before assembling, ensure you have all parts detailed in the parts list on Page 2.
5. Refer to assembly diagram. During assembly, refer to the assembly instructions on following pages.
6. Caution. Keep children away from work area during assembly. Do not allow children to handle parts or tools while assembling.



Assembly Instruction

Dekka Outdoor Coffee Table

FITTINGS IDENTIFICATION

Part #	M620	X	Z
Description:	Screw M6*20	Gasket	Allen Wrench
Figure:	 M6*20	 φ16*φ6.5*1.0	
Qty:	12PCS	12PCS	1PCS

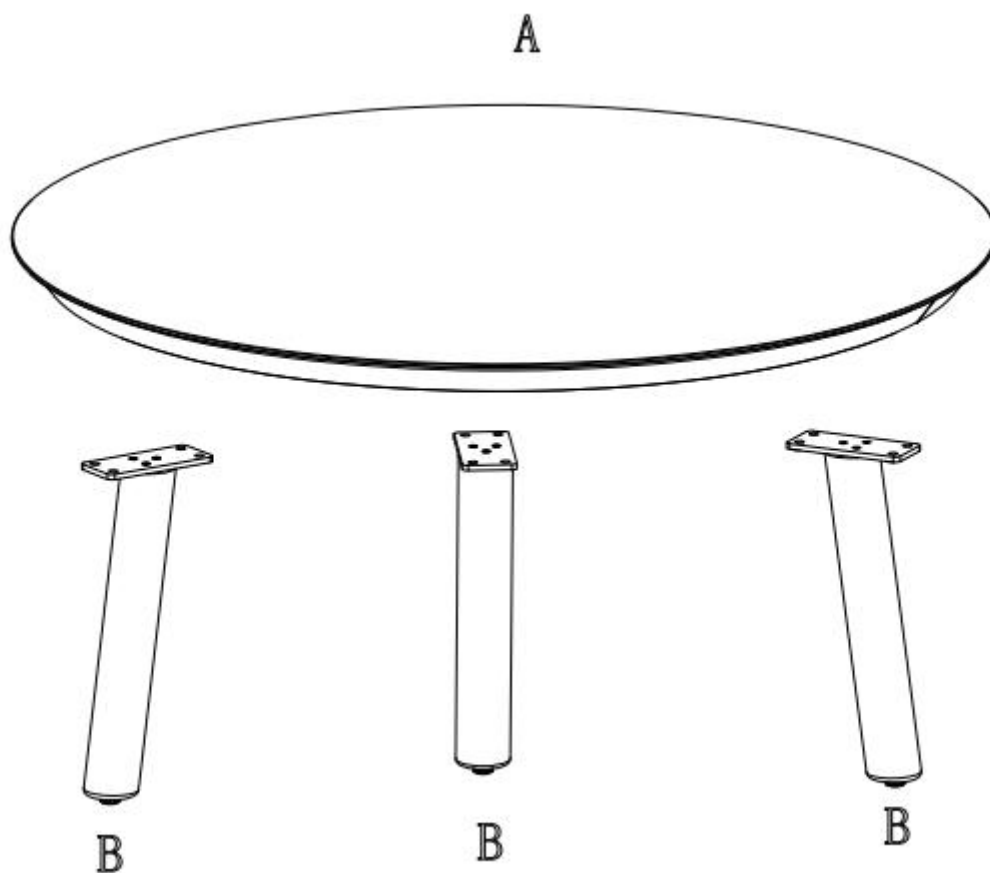
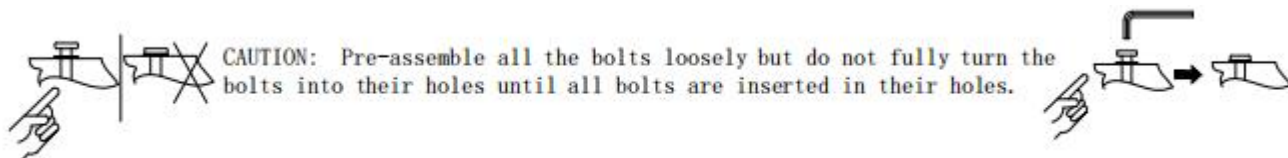

Assembly Instruction

Dekka Outdoor Coffee Table

STEP1

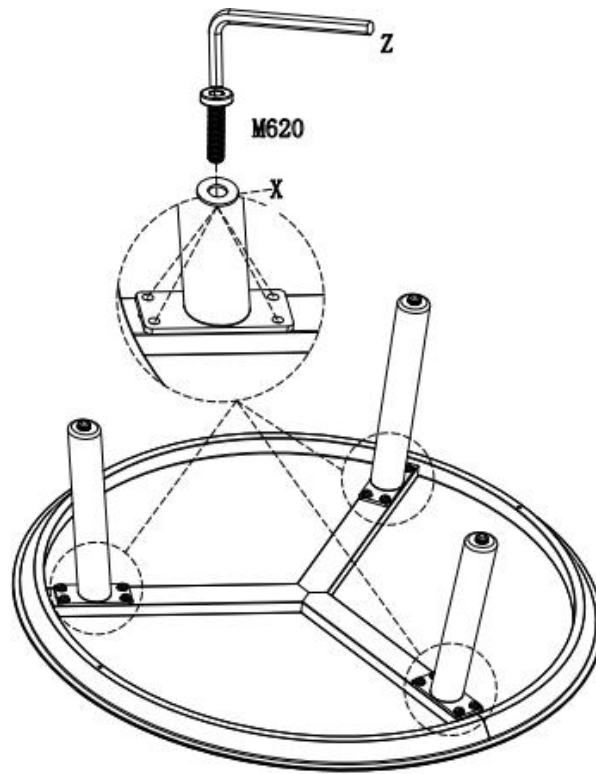

STEP2

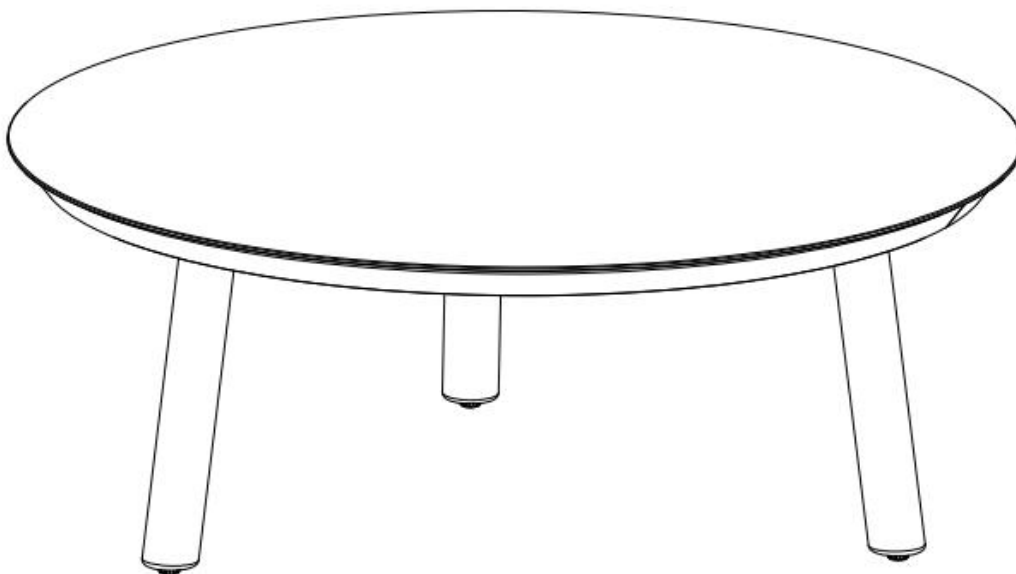

Assembly Instruction

Dekka Outdoor Coffee Table

Steps:

1. Attach the Table leg (Part B) to the Table Top (Part A) with Screw M6*20 (Part M620) and gasket (Part X) by using the Allen Wrench (Part Z)

Tighten all screws. Your chair is ready to use. (Note: Pre-assemble all the bolts loosely but do not fully turn the bolts into their holes until all bolts are inserted in their holes.)

Periodically check and make sure that all screws are fully tightened.