

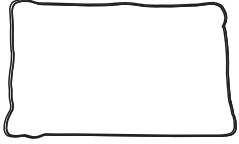

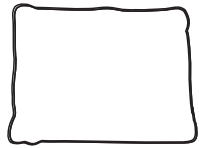

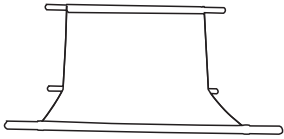

ASSEMBLY INSTRUCTION

Ax1 	Bx1 	Cx1 	Dx1 	Ex1 
Fx1 	Gx1 	Hx1 	Ix8 	Jx1 