

Assembly Instructions

BAR TABLE

CAUTION: You must read this before you proceed.

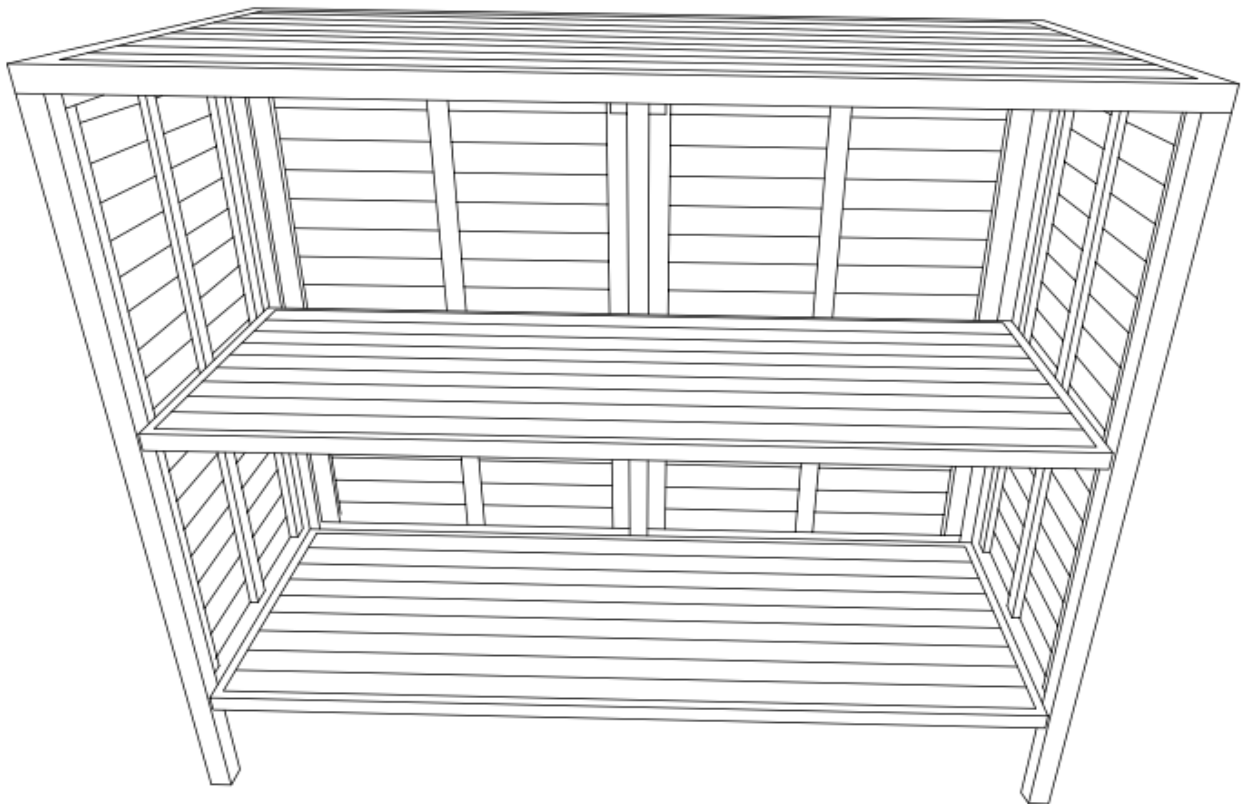



CAUTION : This Bar Table is NOT a TOY.

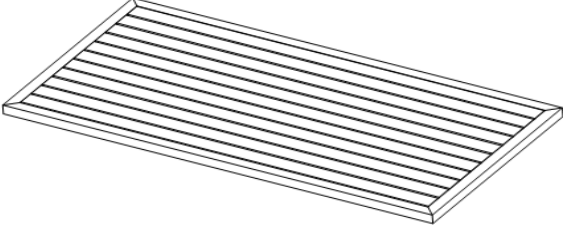

Keep your child / children at bay during the assembly process.

For moving the Bar Table and to prevent damage to the Bar Table, two adults may be needed to execute this action.

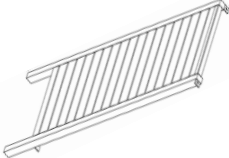
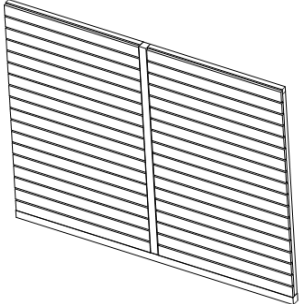
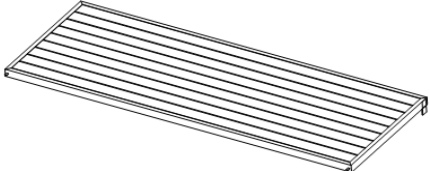
Parts List

No.	Picture	Description	Qty
A		Top Panel	1
B1		Left Leg Panel	1
B2		Right Leg Panel	1
C		Front Panel	1
D		Shelf Panel	2

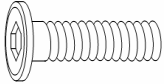
Hardware

No.	Picture	Description	Qty
①		Bolt (M6x25mm)	15
②		Flat Washer	15
③		Allen Key	1

Assembly Preparation

Before Beginning Assembly:

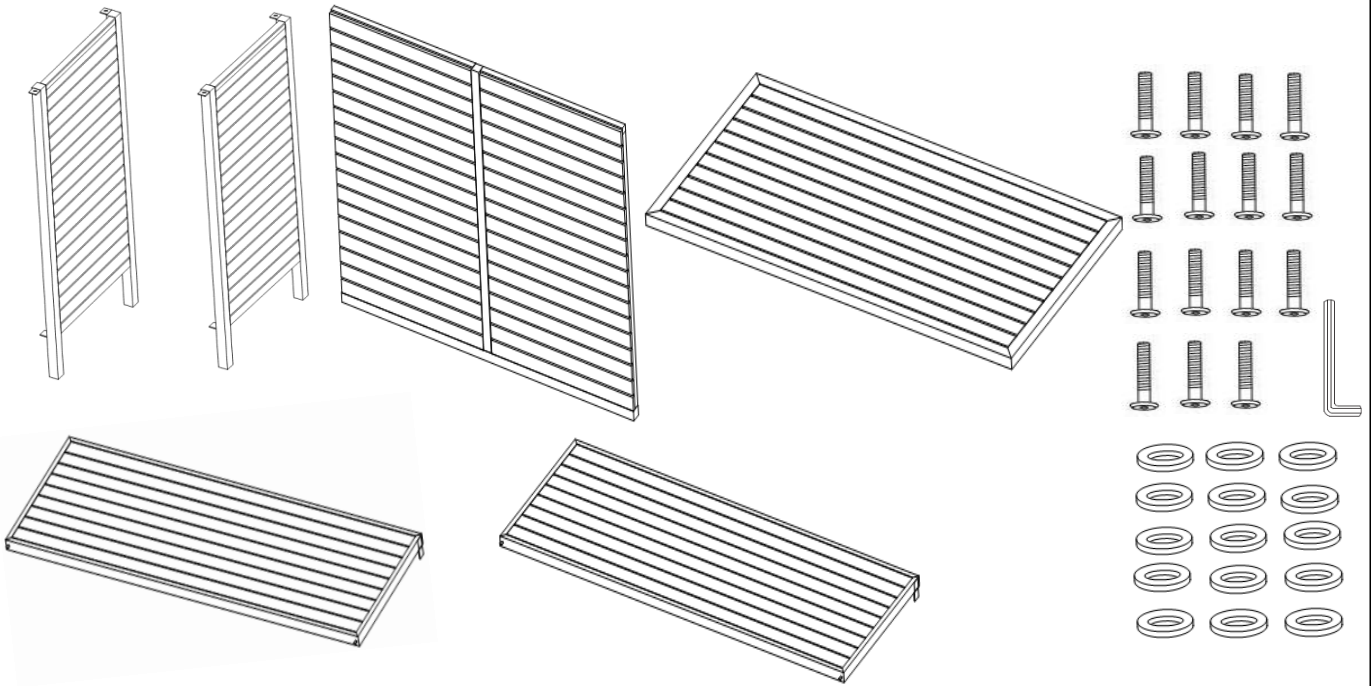

Read instructions, cover to cover.



Have 2 adults on hand for assembly.



Do not assemble on flooring or carpet.



Assemble on a clean non-marring surface (packing foam).



Save all packaging until finished.

Assembly Steps

OVERVIEW

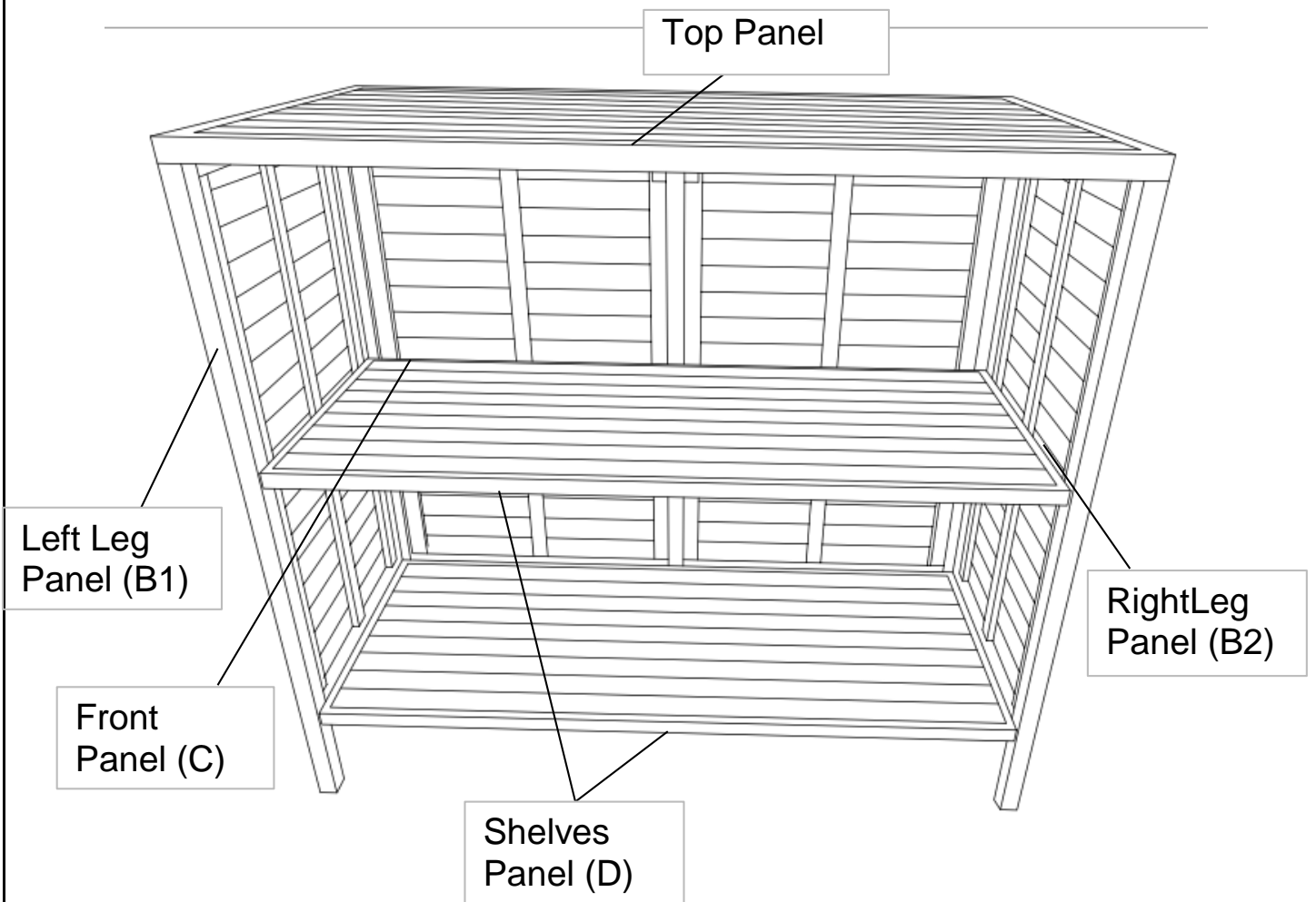

This Bar Table has multiple parts and may require up to 30 minutes to assemble. To give you an overview of the Bar Table parts, the above picture is to help you put the various parts into perspective. Please read through the instructions below to familiarise yourself with the parts and steps before assembly.

Step 1

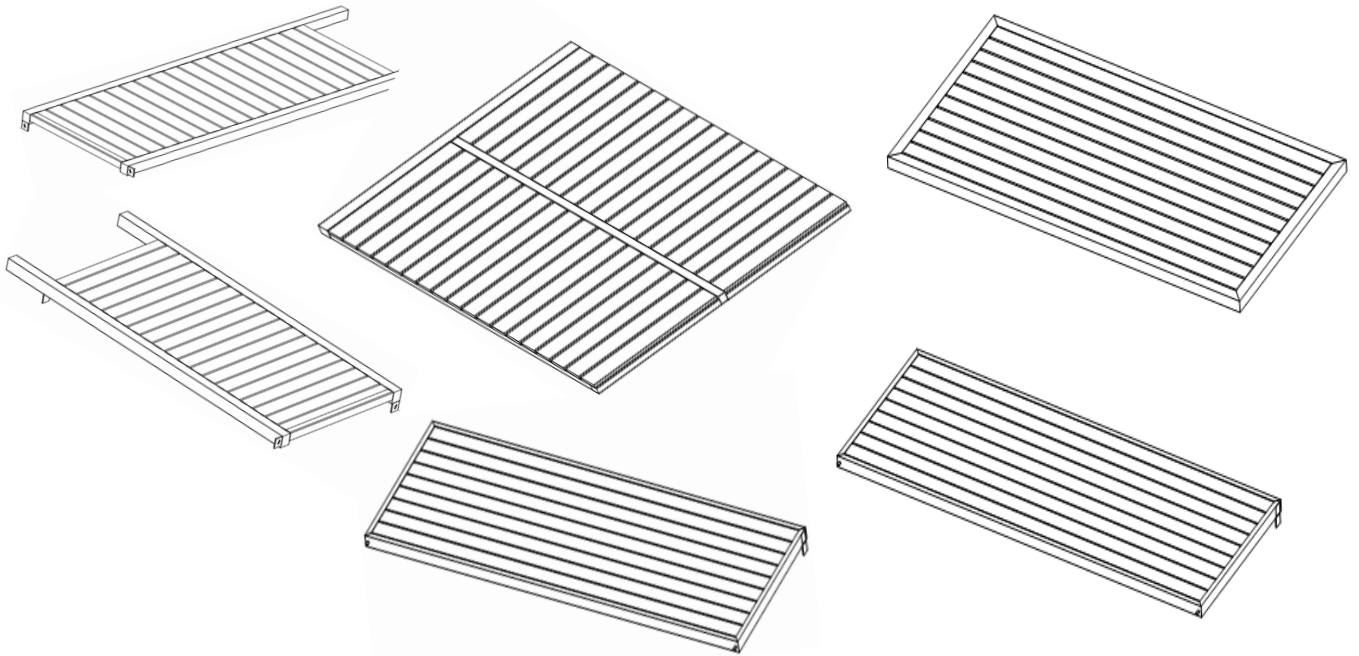

Unpack and place all parts on a clean, non-marring surface.

Step 2

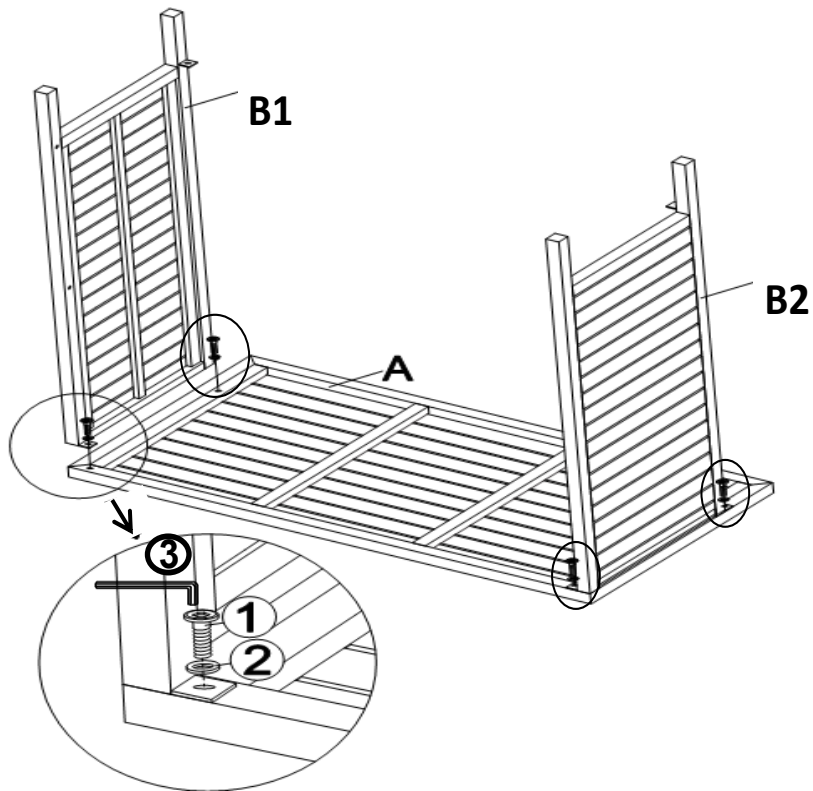

Place the Top Panel(A) facedown onto a clean, non-marring surface.

Position Left Leg Panel(B1) onto the Top Panel (A) and attach using Bolts(①) and Washers(②) with Allen Key(③).

Do not fully tighten Bolts.

Repeat the same process with the Right Leg Panel(B2).

Step 3

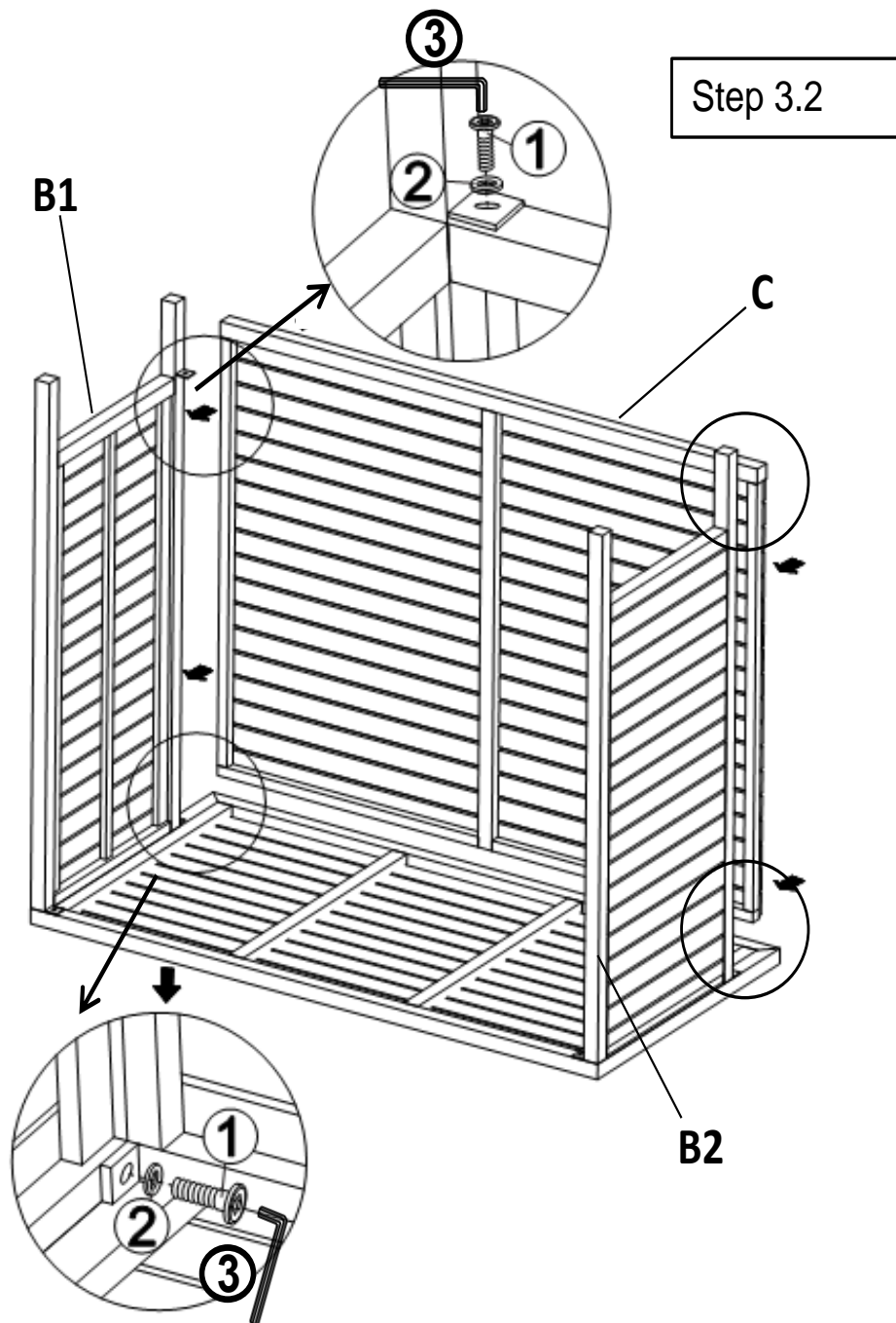

Place the Front Panel(C) into the Frame as pictured above.

3.1) Secure Front Panel(C) to Left Leg Panel(B1) using Bolt(①) and Washer(②) with Allen Key(③)

3.2) Secure Left Leg Panel(B1) to Front Panel(C) using Bolt(①) and Washer(②) with Allen Key(③)

Do not fully tighten Bolts.

Repeat the same process with Right Leg Panel(B2) and Front Panel(C)

Step 4

Step 4.3

Step 4.2

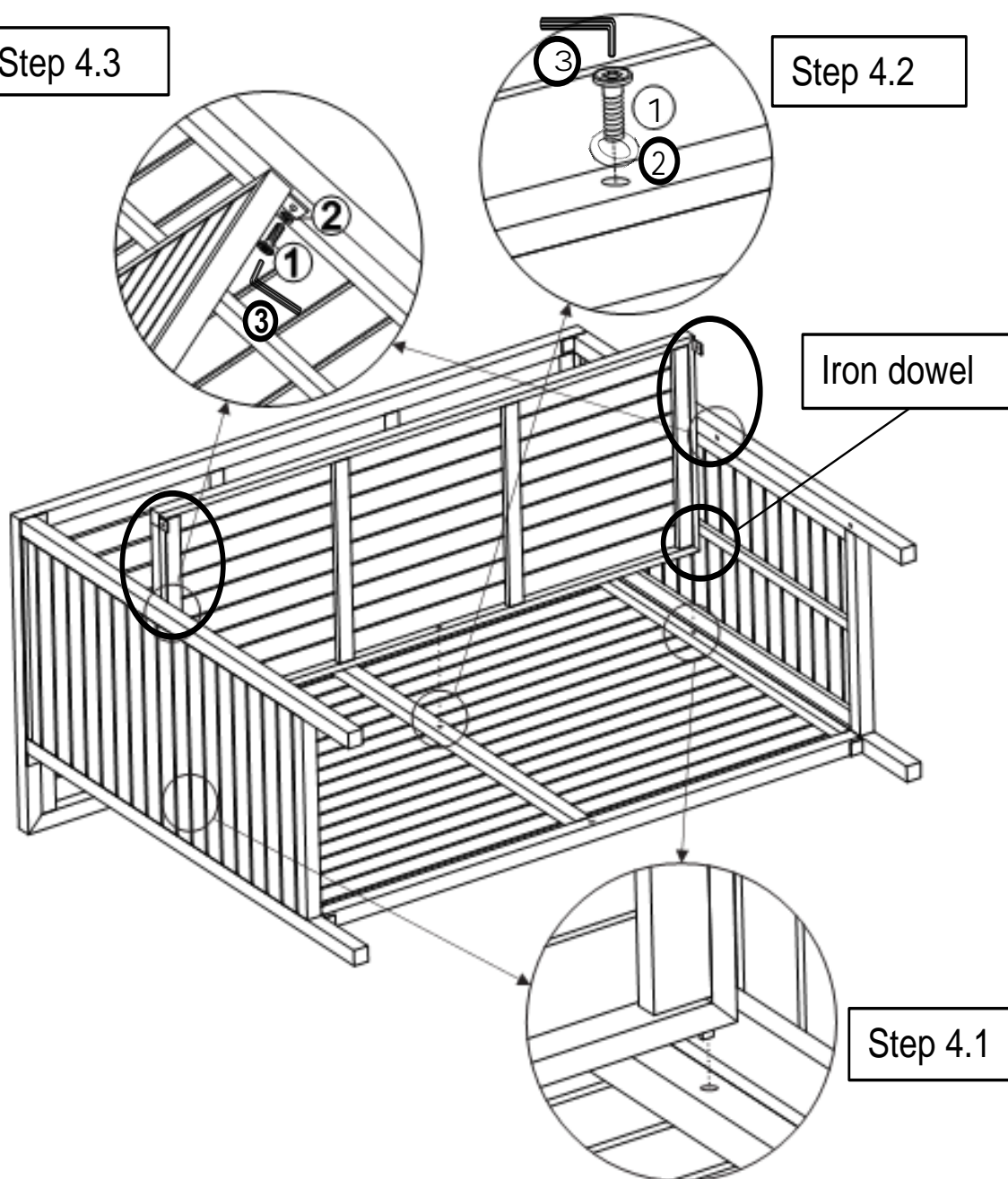

With the assistance of an adult helper, lay the frame down as shown.

4.1) Position Shelf Panel(D) between the Legs so the prefixed iron dowels of Shelf Panel(D) are in the housing on Front Panel(C)

4.2) Secure middle point of Shelf Panel(D) to Front Panel(C) by using Bolt(①) and Washer(②) with Allen Key(③).

4.3) Secure Shelf Panel(D) to Left Leg Panel(B1) and Right Leg Panel(B2) by using Bolts(①) and Washers(②) with Allen Key(③)

Do not fully tighten the Bolts.

Repeat the same process to the other Shelf Panel(D)

In a sequential manner, tighten all Bolts at all joints until fully locked into position

Step 5

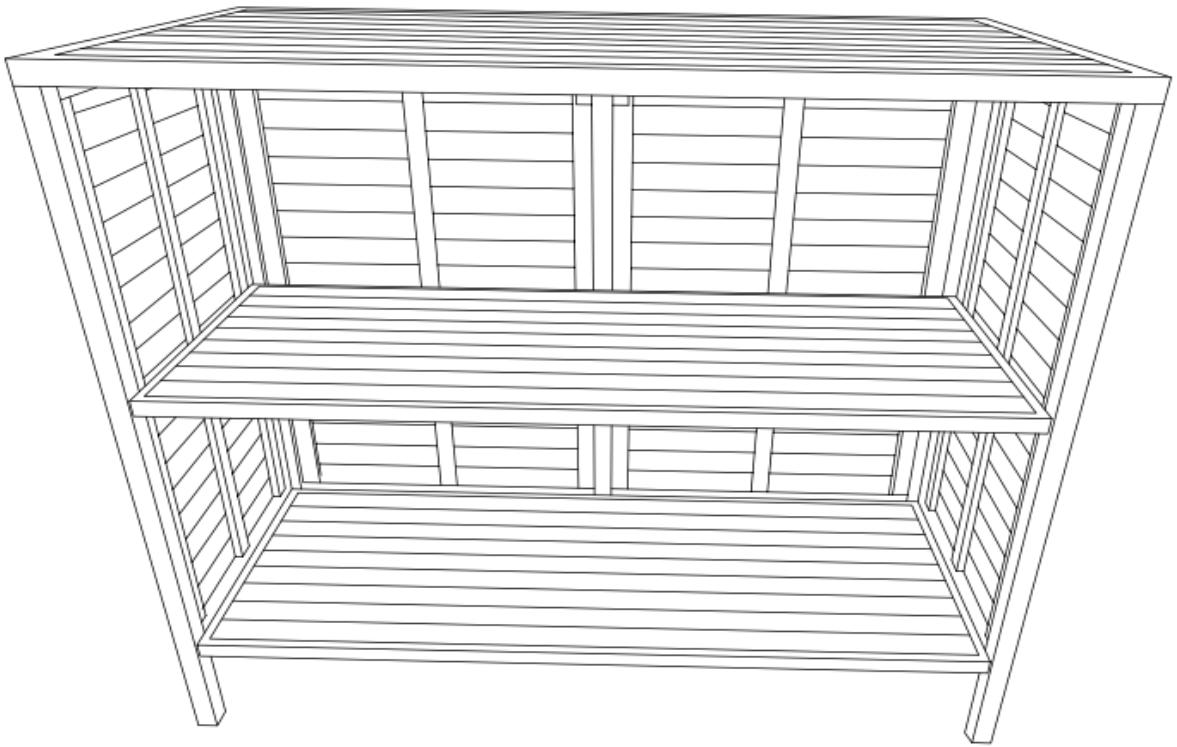



















With the assistance of an adult helper, stand the Bar Table up.

Ensure all Bolts are fully locked into position.

Your Bar Table is ready for use.

This Bar Table can only be used on a flat, level surface.

Care & Maintenance

-   ● Do not put hot items directly on furniture surface
 -   ● Do not clean furniture with harsh cleansers or polish.
 -   ● To obtain the longest lifespan of your outdoor products, minimizing exposure to direct sunlight is recommended.
 -   ● Children should not climb or jump on the furniture.
 -   ● Do not write on furniture without a padded barrier to protect the surface.
 -   ● To obtain the longest lifespan of your outdoor products, avoid extended and lengthy exposure to rain, snow, and direct sunshine. Whenever possible cover the product and /or place under patio or awnings.
 -   ● Not for commercial use. For residential use only .
 -   ● Stains may be removed with mild soap solution and damp cloth.
-
-   ● Dust and pick-up spills using a clean, non-colored, lint-free cloth .