

PARTS LIST / LISTE DES PIÈCES / LISTA DE PIEZAS

DESCRIPTION / DESCRIPCIÓN : SIDE ENTRY CURIO / ARMOIRE VITRÉE À OUVERTURE LATÉRALE /  
VITRINA CON ACCESO LATERAL

**WARNING**

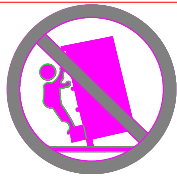

**Serious or fatal crushing injuries can occur from furniture tip-over. To help prevent tip-over:**

- install tipover restraint provided.
- Place heaviest items in the lowest drawers.
- Do not set TV's or other heavy objects on top of this product unless the product is specifically designed to accommodate them.
- Never allow children to climb or hang on drawers, doors, or shelves.
- Never open more than one drawers at a time (OR)
- Do not defeat or remove the drawers interlock system.

**Use of tip-over restraints may only reduce, but not eliminate, the risk of tip-over.**  
this is a permanent label. Do not remove!

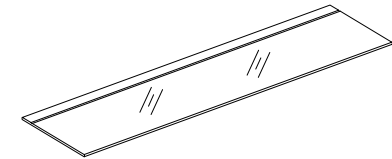
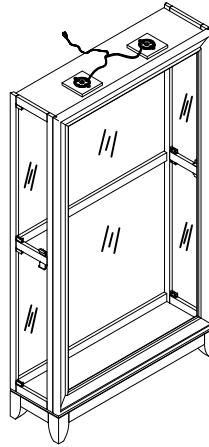
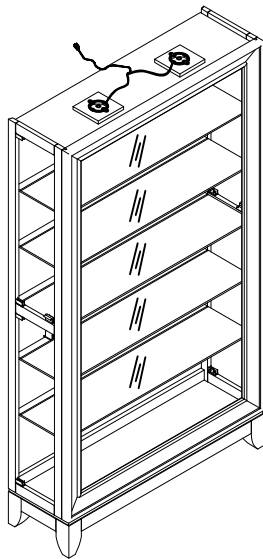

**A**

x1 Side Entry Curio  
x1 Armoire vitrée à ouverture latérale  
x1 Vitrina con acceso lateral

**B**

x5 Glass shelf \*  
x5 Étagère en verre  
x5 Estante de vidrio



**C**

x20 Common Shelf Support \*  
x20 Supports Pour Tablette  
x20 Soporte De Las Repisas

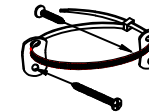

**D**

x1 Furniture Tipping Restraint  
x1 Systeme antibasculément  
x1 Control para evitar vuelcos

\* Replaceable Part

**▲ WARNING**



**Serious or fatal crushing injuries can occur from furniture tip-over. To help prevent tip-over:**

- install tipover restraint provided.
- Place heaviest items in the lowest drawers.
- Do not set TV's or other heavy objects on top of this product unless the product is specifically designed to accommodate them.
- Never allow children to climb or hang on drawers, doors, or shelves.
- Never open more than one drawers at a time (OR)
- Do not defeat or remove the drawers interlock system.

**Use of tip-over restraints may only reduce, but not eliminate, the risk of tip-over. this is a permanent label. Do not remove!**

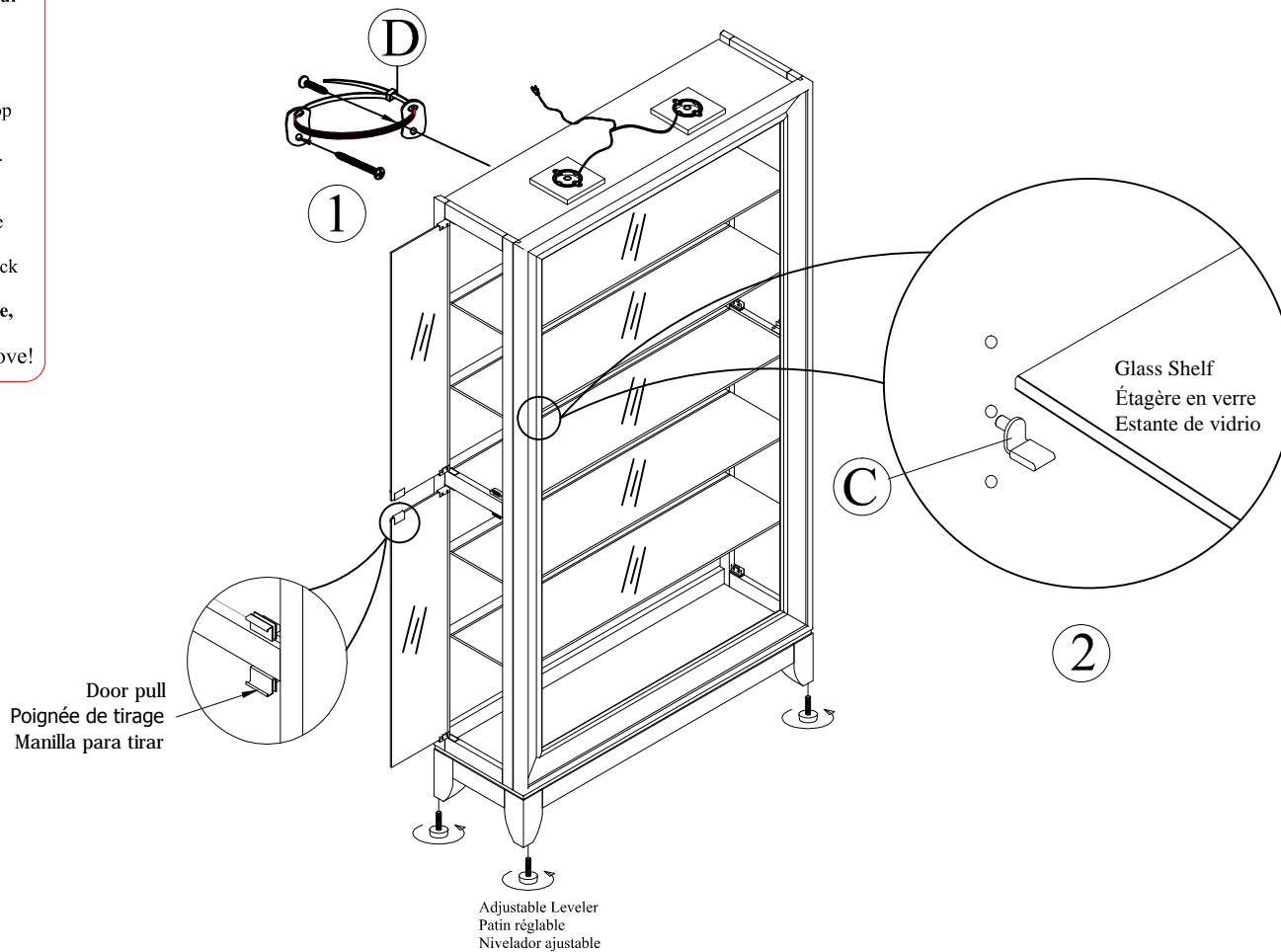
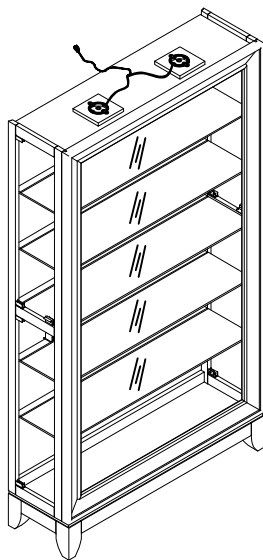

REPLACEABLE PART / PARTIE REMPLACABLE / PARTE REEMPLAZABLE

DESCRIPTION / DESCRIPCIÓN : SIDE ENTRY CURIO / ARMOIRE VITRÉE À OUVERTURE LATÉRALE /  
VITRINA CON ACCESO LATERAL

**WARNING**

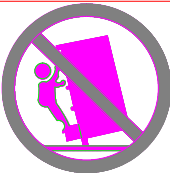

**Serious or fatal crushing injuries can occur from furniture tip-over. To help prevent tip-over:**

- install tipover restraint provided.
- Place heaviest items in the lowest drawers.
- Do not set TV's or other heavy objects on top of this product unless the product is specifically designed to accommodate them.
- Never allow children to climb or hang on drawers, doors, or shelves.
- Never open more than one drawers at a time (OR)
- Do not defeat or remove the drawers interlock system.

**Use of tip-over restraints may only reduce, but not eliminate, the risk of tip-over. this is a permanent label. Do not remove!**

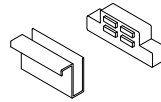
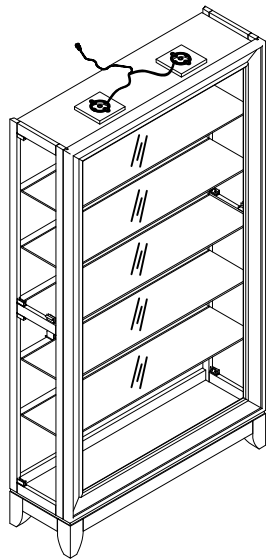

x4  
Glass Door Pull (Brass) with Felt \*  
Poignée (Laiton) et Feutre  
Tirador (Latón) y Fieltro

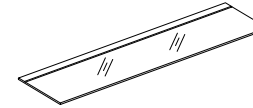

x5  
Glass shelf \*  
Étagère en verre  
Estante de vidrio



x8  
Glass Hinge (Nickle) \*  
Charnière (Nickle)  
Bisagra (Níquel)



x1  
Wall Hanger Brackets \*  
Ferrure  
Ménsula



x4  
Door Glass \*  
Porte en verre  
Puerta de vidrio



x20  
Common Shelf Support \*  
Supports Pour Tablette  
Soporte De Las Repisas

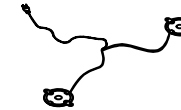

x1  
Light fixture w/roll switch \*  
lumière et interrupteur  
luz y interruptor



x4  
Brown Leveler \*  
Patin réglable  
Nivelador

\* Replaceable Part