

Daybed Trundle

Assembly Instructions

1 Assembled View

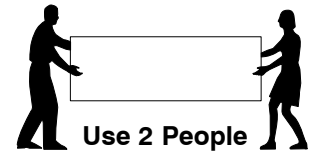
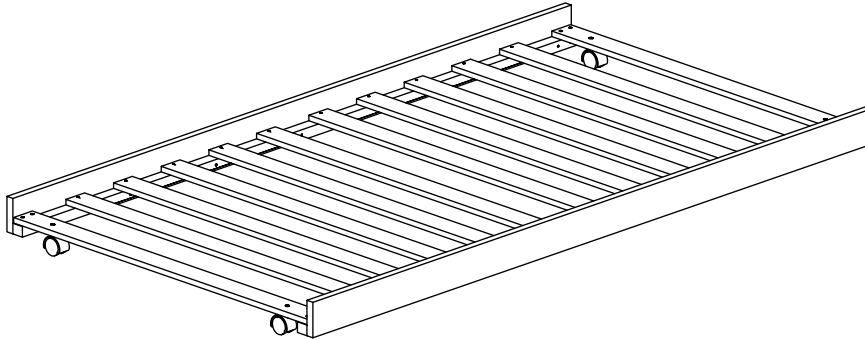

Note: Do not assemble using power tools. This can cause the bolts to be overtightened

2 Parts List



A Trundle Panel x 2

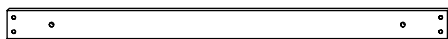

B Trundle Support Rail x 2

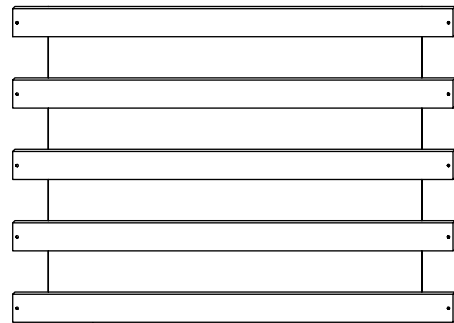

C Set of Slats x 2

3 Hardware List



1 M6 x 40mm JCB
x 8

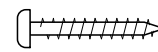

2 Wood Screw
(M4 x 32mm)
x 20



3 Allen Key
x 1

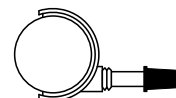

4 Wheels
x 4

Daybed Trundle

Assembly Instructions

4 Fit the Wheels (4) to the Trundle Support Rail (B).

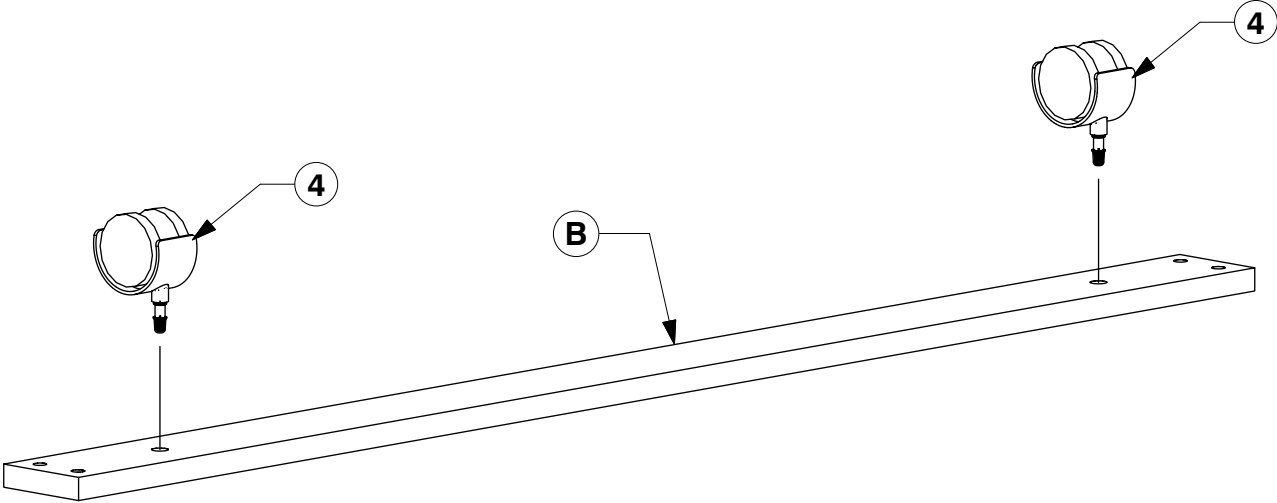

5 Assemble the Set of Slats (C) & Trundle Support Rail (B) to the Trundle Panel (A).

