

BAR TABLE

ASSEMBLY INSTRUCTION



ASSEMBLY INSTRUCTION

ASSEMBLY TIPS:

- 1.Remove hardware from box and sort by size.
- 2.Please check to see that all hardware and parts are present prior to start of assembly.
- 3.Please follow attached instructions in the same sequence as numbered to assure fast & easy assembly.







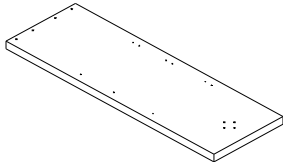
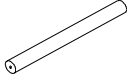
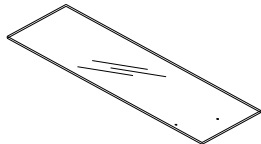

Warning!!

- 1.Don't attempt to repair or modify parts that are broken or defective. Please contact the store immediately.
- 2.This product is for home use only and not intended for commercial establishment.

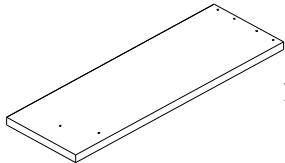

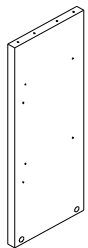

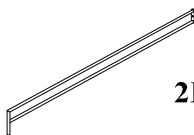











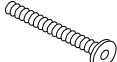

ASSEMBLY TIME PER UNIT: 50 MINUTES

PARTS IDENTIFICATION:

<p>A</p> <p>TOP WOOD</p>  <p>1PC</p>	<p>F</p> <p>LARGE CROSSBAR</p>  <p>2PCS</p>
<p>B</p> <p>SHELF GLASS</p>  <p>2PCS</p>	<p>G</p> <p>BOTTOM CROSSBAR</p>  <p>1PC</p>
<p>C</p> <p>BOTTOM WOOD</p>  <p>1PC</p>	<p>H</p> <p>HANGER BRACKET</p>  <p>3PCS</p>
<p>D</p> <p>SIDE WOOD</p>  <p>1PC</p>	<p>I</p> <p>SMALL CROSSBAR</p>  <p>1PC</p>
<p>E</p> <p>CENTER SUPPORT BAR</p>  <p>2PCS</p>	

ASSEMBLY INSTRUCTION

HARDWARE PACKAGE

Z	DESCRIPTION	FIGURE	Q'TY
1	CAM-LOCK (ϕ 15mm)		2PCS
2	CAM-BOLT (38mm)		2PCS
3	WOOD DOWEL (10x50mm)		4PCS
4	GLASS METAL (10mm)		4PCS
5	GLASS BOLT (8x8mm)		4PCS
6	SMALL SCREW (7#x15mm)		20PCS
7	BOLT (5/16"x2-1/2")		3PCS
8	LARGE SCREW (5.5x70mm)		2PCS
9	BOLT (ϕ 50mm)		5PCS
10	SMALL WASHER (1/4"x19mm)		1PC
11	SMALL ALLEN BOLT (1/4"x1")		1PC
12	ALLEN BOLT (5/16"x76mm)		1PC
13	FOOT PIN (ϕ 17mm)		5PCS
14	STICKER (ϕ 20mm)		2PCS
15	ALLEN WRENCH (4mm,5mm)		1PC
16	LARGE WASHER (5/16")		1PC
17	ROUND IRON (ϕ 63mm)		1PC
18	SPRING WASHER (5/16")		1PC
19	LARGE ALLEN (1/4"x235mm)		1PC
20	GLUE		1PC

STEP 1

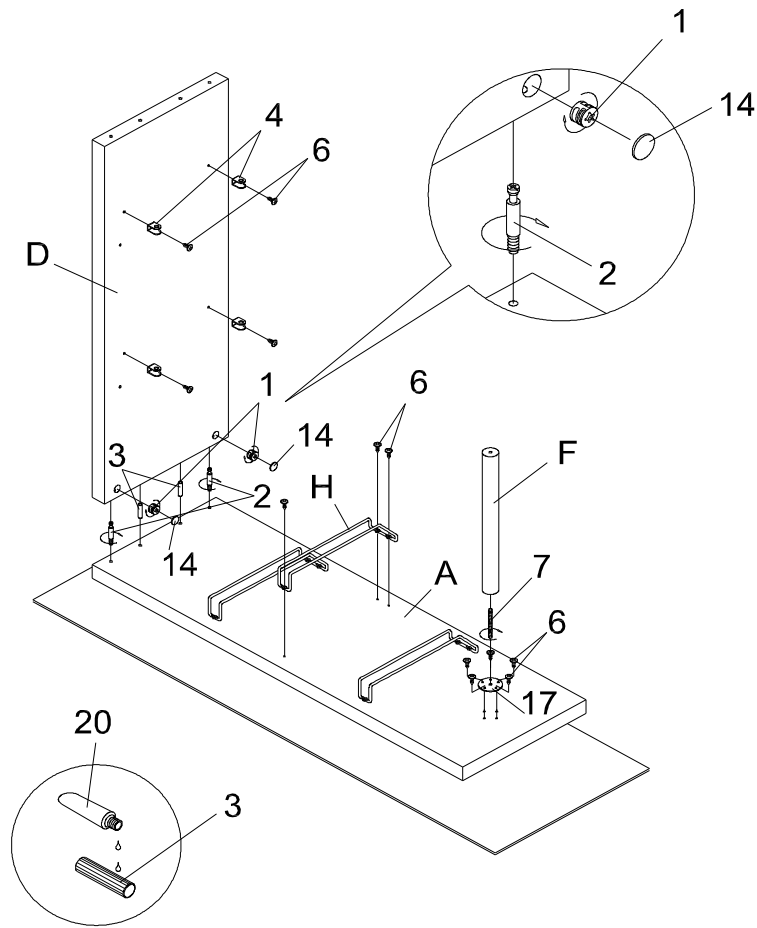

STEP 2

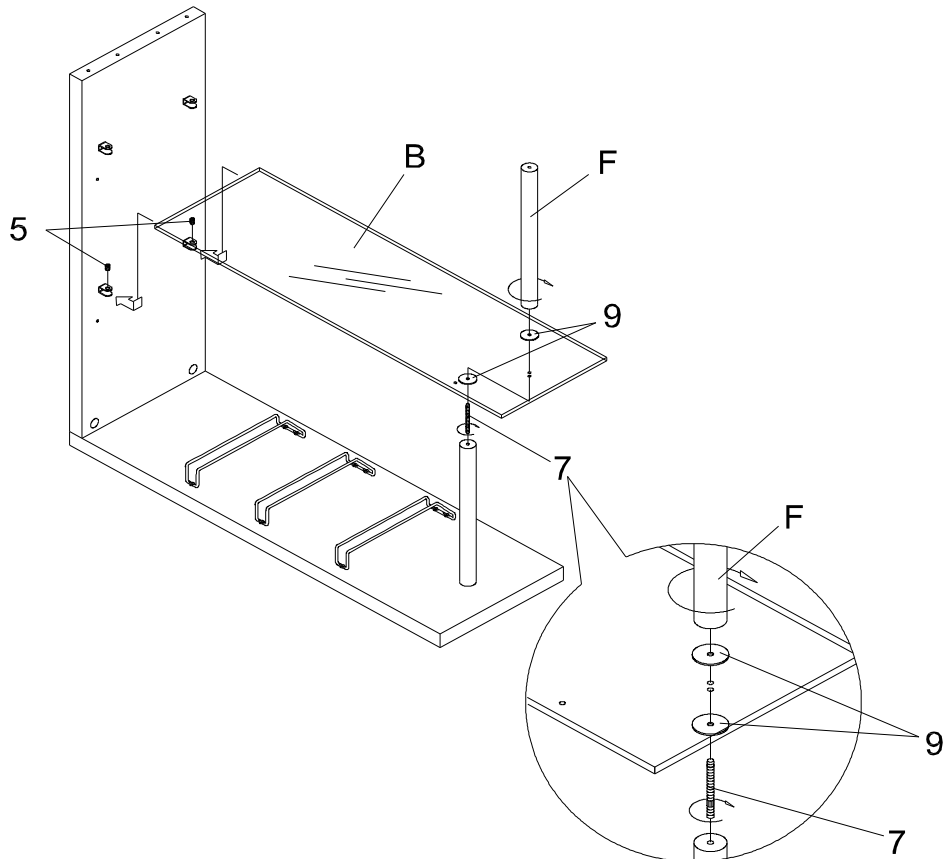

STEP 3

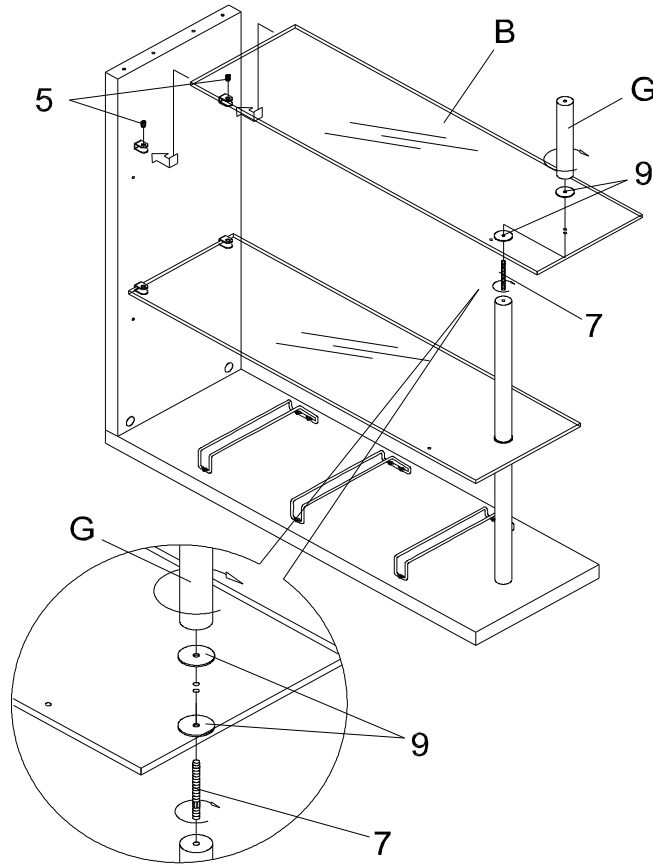

STEP 4

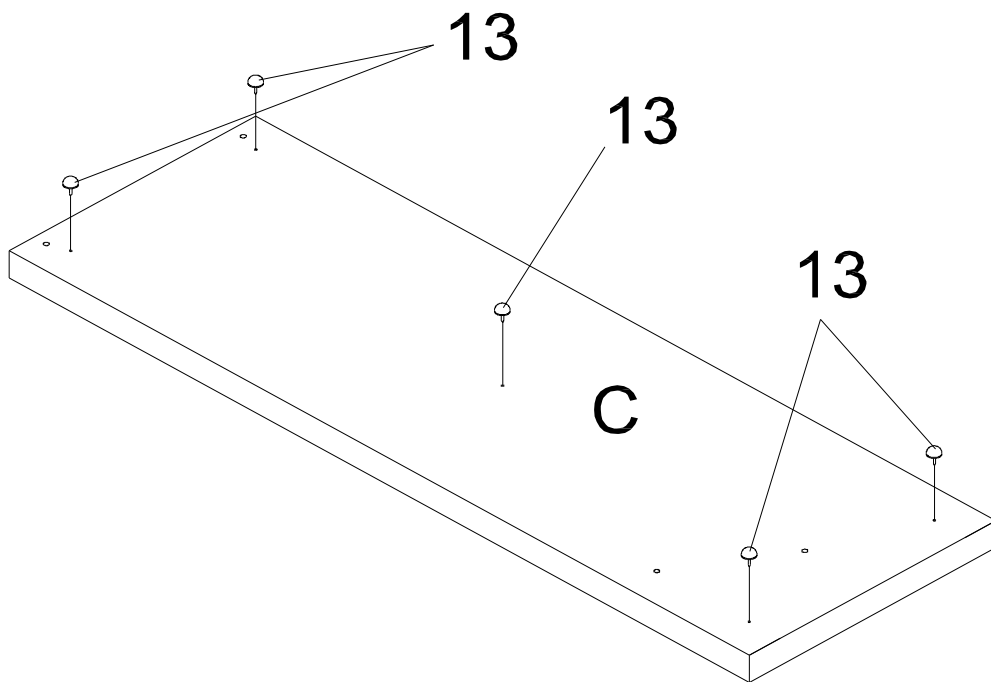

STEP 5

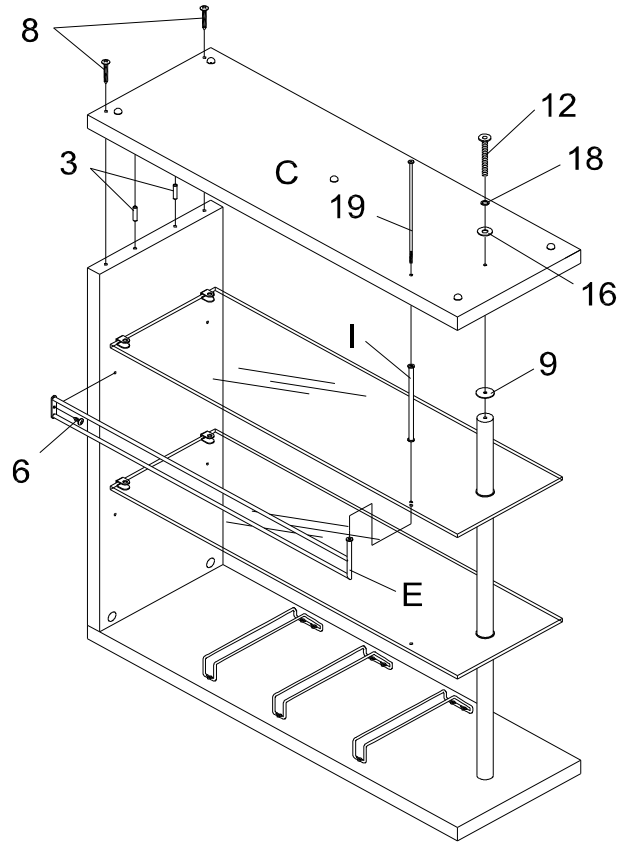

STEP 6

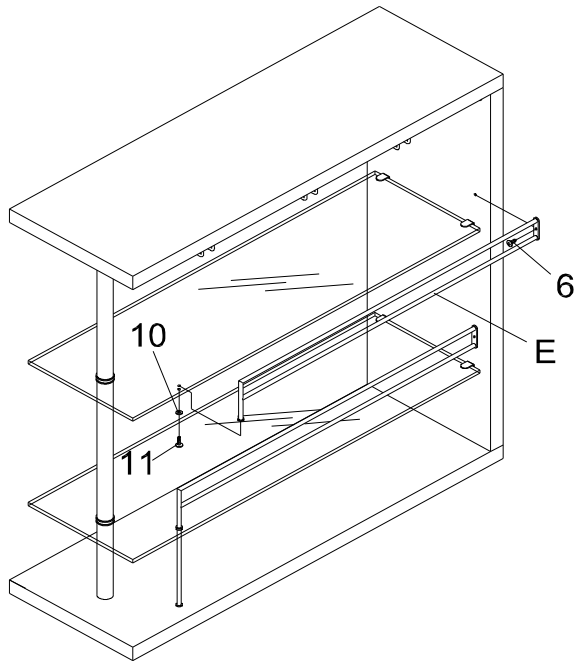

FINISH

