

ASSEMBLY & INSTALLATION INSTRUCTIONS

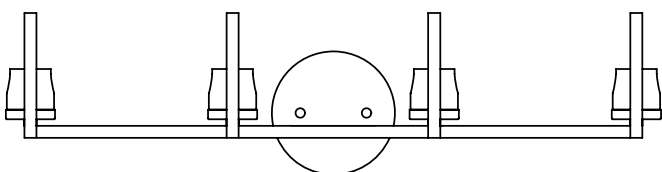
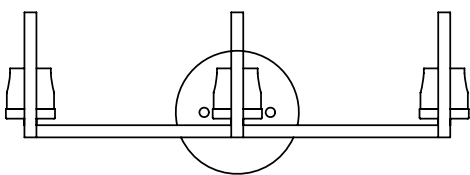
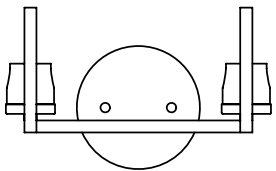
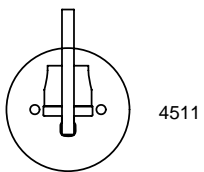
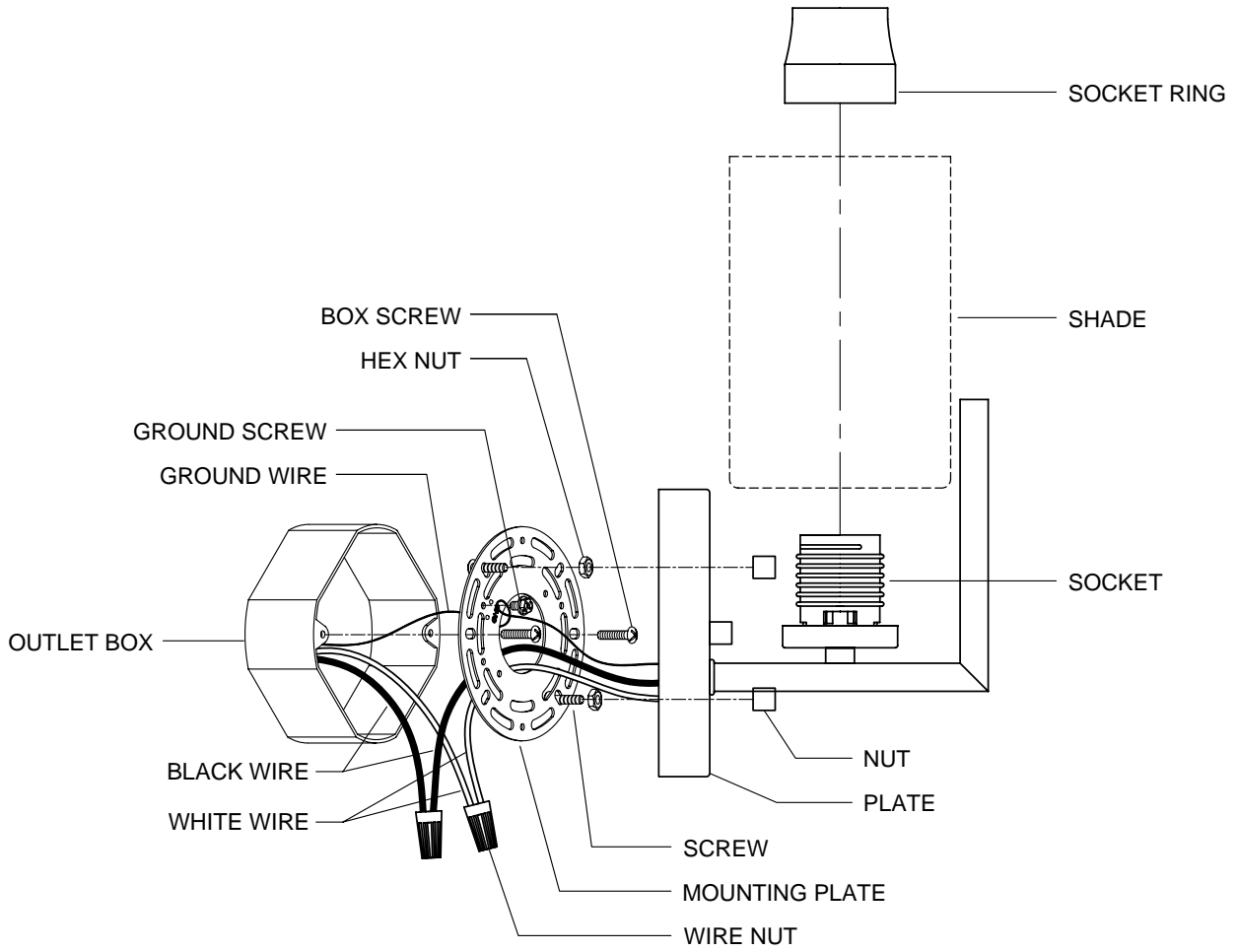

Wall Mount Fixture Installation and Wiring Instructions

NOTE: ALWAYS TURN POWER OFF BEFORE INSTALLING LIGHTING FIXTURES!

IMPORTANT: YOU SHOULD USE A QUALIFIED ELECTRICIAN TO INSTALL THIS FIXTURE.

Installation (see Fig.A)

1. Disconnect power at main electrical panel before installation.
2. Thread the **mounting screws** into the opposite side of the **mounting plate** from the **GREEN ground screw**.
3. Guide **fixture wires** through hole in center of **mounting plate**.
4. Follow wiring instructions carefully (listed below).
5. Attach **mounting plate** to **outlet box** using **box screws** provided with **outlet box**.
6. Thread **Hexnut** onto mounting screws.
7. Mount fixture by aligning mounting holes in **canopy** with **mounting screws** and threading **ball nuts** onto **mounting screws**. Tighten to firmly hold **canopy** in place against wall (**mounting screws** may require adjustment).

Wiring (see Fig.B)

1. Split the conductors of the **fixture wire** about 4 inches. Being careful not to expose any of the wire inside of the insulation.
2. Connect the **fixture ground wire** to the **outlet box ground wire** using **wirenut** (not provided). Connect **outlet box ground wire** to **mounting plate** with **GREEN hex-head ground screw** to tapped hole in **mounting plate** marked "GND".
3. Connect the half of the **fixture wire** that is white, marked, or has a ribbed surface to the **outlet box supply wire** (WHITE). Connect the other half of the **fixture wire** that is black, unmarked or has a smooth surface to the outlet box **supply wire** (BLACK or RED). Use **wirenuts** provided.
4. Spread the electrical splices so that the black wire are on one side of the **outlet box** and the white wire are on the other side.

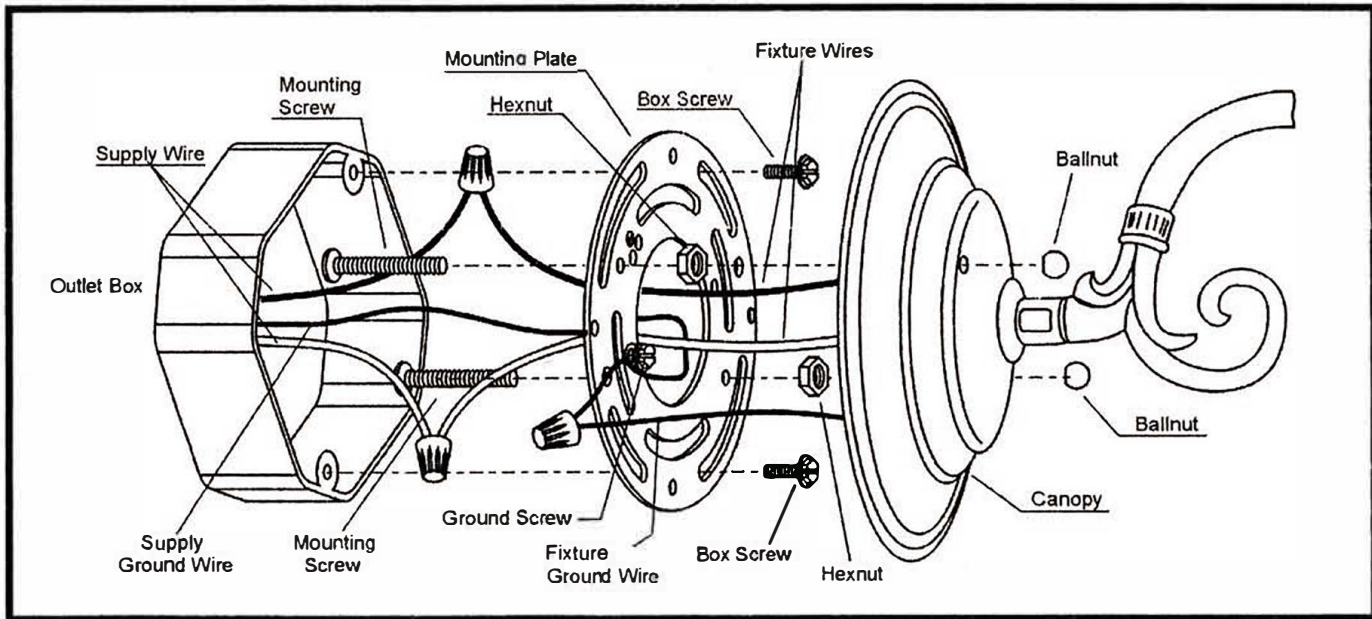

Fig. A

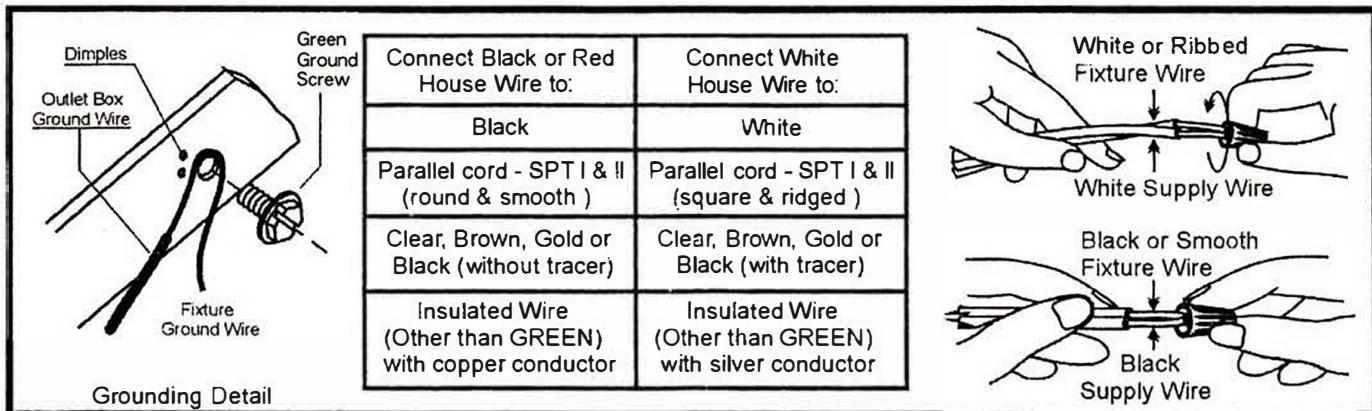

Fig. B