

# Assembly Instructions

## Heavy Duty Swing Set

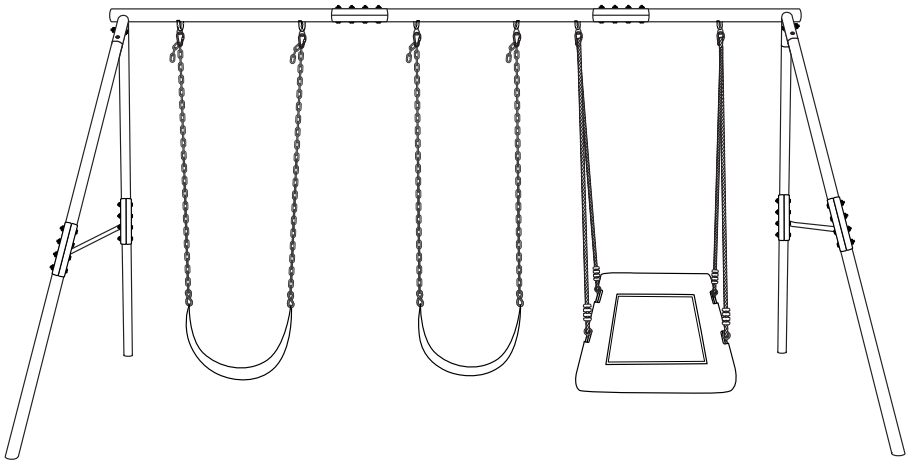

## **SAFETY INSTRUCTION**











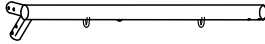
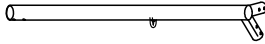

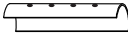
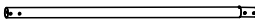
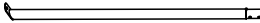
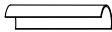
### **The safety of your children is our primary concern!**

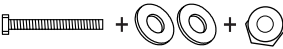

- The swing set is **ONLY** for domestic use, not for public use.
- Do not use this swing set on hard-packed soil, concrete, or any kind of hard surface.
- The swing set should be set on a flat surface and maintained a distance of 80 inches. from other structures or obstacles, such as fences, garages, houses, projecting branches, clotheslines or electric cables, etc.
- Children **MUST NOT** use this swing set until the installation is complete.
- Choking hazard! Small parts should be kept away from children.
- Children under 3 years old are not suitable for playing this product.
- Children must be under the supervision of adults when they contact or use the product to prevent the risk of falling or the strangulation of long ropes.
- Do **NOT** allow children to get close to the moving swings or other moving equipment.
- Do **NOT** allow children to get off the swing while it is swinging.
- The recommended height from the ground to the swing seat is 20 inches.

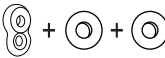
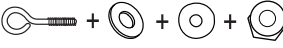
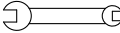
## **MAINTENANCE INSTRUCTION**

- It is important to check and maintain the swing set regularly.
- Make sure that all hardware and accessories are in good condition.
- Always replace the defective parts with original spares.
- Do not expose the swings in the rainy season.
- Check and tighten all hardware before using.
- Check the protective covering of bolts, pipes, edges and corners, and replace in time if they are loose, cracked or missing.
- Check all moving parts including ropes, swing seats, cables and chains in case of wear, rust or other deterioration.
- At the end of each play season or when the temperature drops below 32 degrees Fahrenheit, remove and put away the plastic swing seats and other equipment.

## Parts List

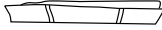

Quantity		
1	A1	 A1 tube
1	A2	 A2 tube
1	B	 B tube
4	C	 Casing tube
4	D	 D top leg
4	E	 E bottom leg
8	F	 Reinforcing armor for leg
2	G	 G side bar
4	H	 Anchor
1	I	 Extension bar
32	J	 M10 bolt + washer(x2) + nut
6	K	 Bolt + washer(x2) + nonslip nut
6	L	 Bearing suspension parts (suspension hoop + bushing + rubber washer)
4	M	 M8 eye bolt + washer + big washer + M8 nonslip nut
2	N	 Spanner
1	O	 Spanner
6	P	 Carabiner
2	Q	 Belt swing
2	R	 Suspension rope with bolt and nut

1		Platform swing
2		U tube with foam for square swing
2		Long tube with foam for square swing

## Assembly Instructions

### Step1: Beam Installation

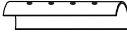
Accessories required:

4 pcs	C		Casing tube
8 set	K		M10 bolt + washer(x2) + nut

- Flip the A1 tube and B tube over with the connection ports facing up as shown. Keep tubes A and B on a level, connect them with the C casing tube and align holes. Flip over again and secure them with accessories J.

**Please make sure the B tube is connected with the A1 tube in the correct direction as shown below.**

- Repeat the same process for the A2 tube: connect the A2 tube and B tube and secure with casing tube C and accessories J.

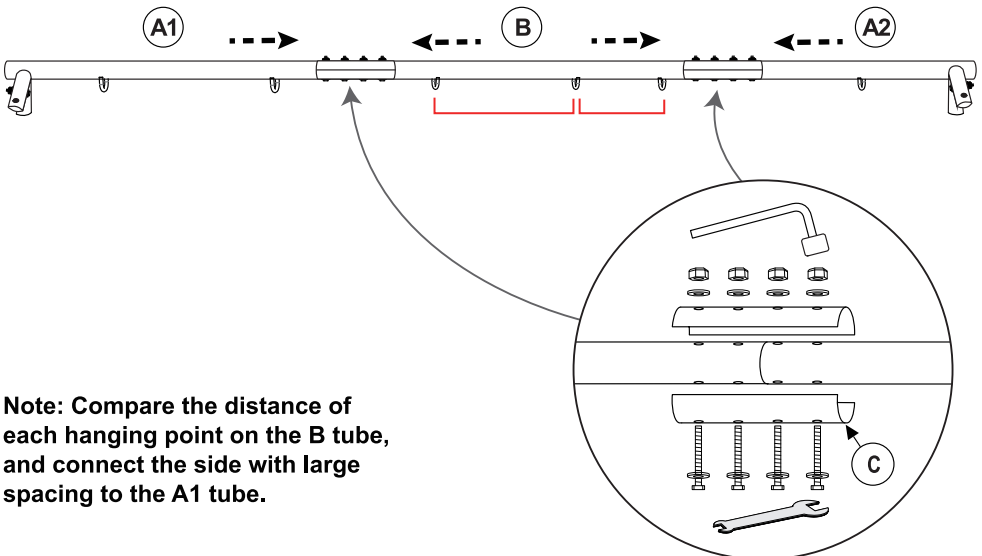

**Note:** For easier assembly, do not tighten the bolts initially to allow room for adjustment. You must go back and fully tighten all bolts after the entire swing set is assembled.



**Note:** Compare the distance of each hanging point on the B tube, and connect the side with large spacing to the A1 tube.

## Step2: Bearing Suspension Parts Installation

Accessories required:

6 set	K 	Bolt + washer + nonslip nut
6 set	L 	Bearing suspension parts (suspension hoop + bushing+ rubber washer)

- Insert the bushing to the big hole of the suspension hoop, and stick two rubber washer to the assembled suspension hoop, then fix the suspension parts on the beam with bolt accessories L, as shown below.

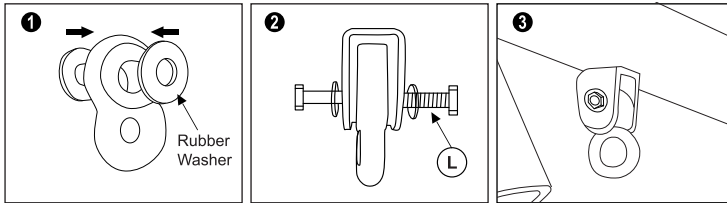

## Step3: D Top Legs Installation

Accessories required:

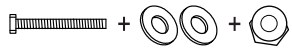

8 set	J 	M10 bolt + washer(x2) + nut
-------	---	-----------------------------

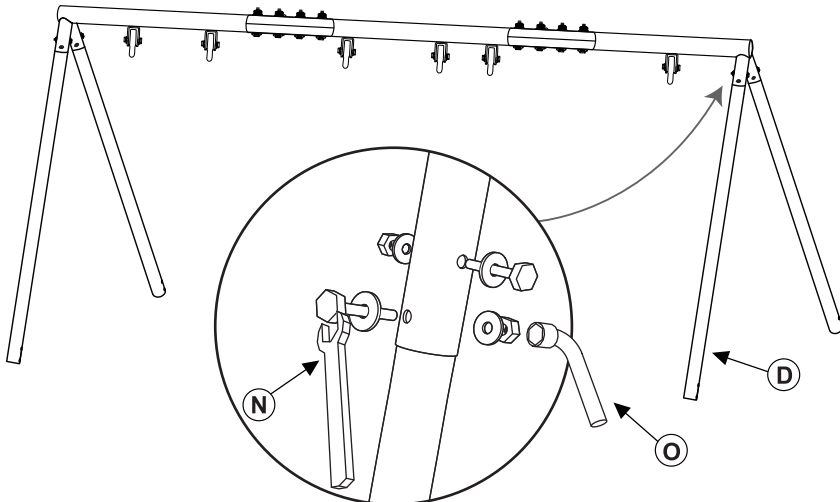
- Install the D top legs and secure with reinforcing armors F and bolt accessories K, as shown below.

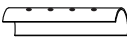

#### Step4: E Bottom Legs and G Side Bars Installation

Accessories required:

8 pcs	F		Reinforcing armor for leg
16 set	J		M10 bolt + washer(x2) + nut

- Connect the D top legs and the E bottom legs, install the G side bars to the second holes on leg tubes, and secure with reinforcing armors F and bolt accessories K, as shown below.

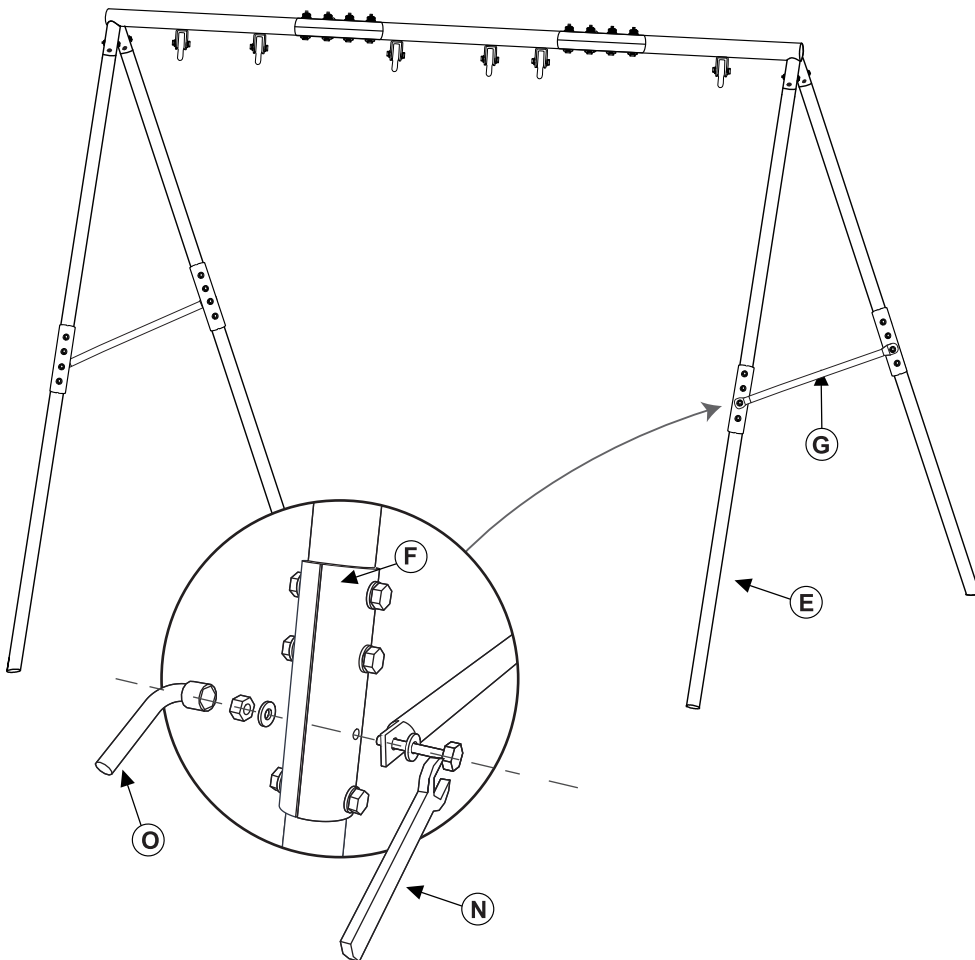

**Note:** The side tubes should be installed on the outside of the bracket.



**Step5: The frame is fully assembled, please go back to tighten all the bolts.**

**Step6: Anchor Installation**

Accessories required:

4 pcs	H		Anchor
1 pcs	I		Extension bar
4 set	M		M8 eye bolt + washer + big washer + M8 nonslip nut

- After the entire swing set is assembled, fix the anchors to the position you intended by using the extension bar ( I ).

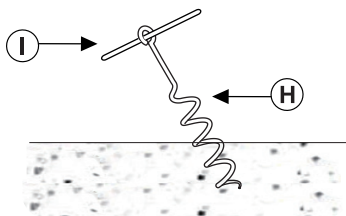

- Align the anchor ring to the hole of the bottom leg. Fix the anchor with the eye bolt and tighten the nut.

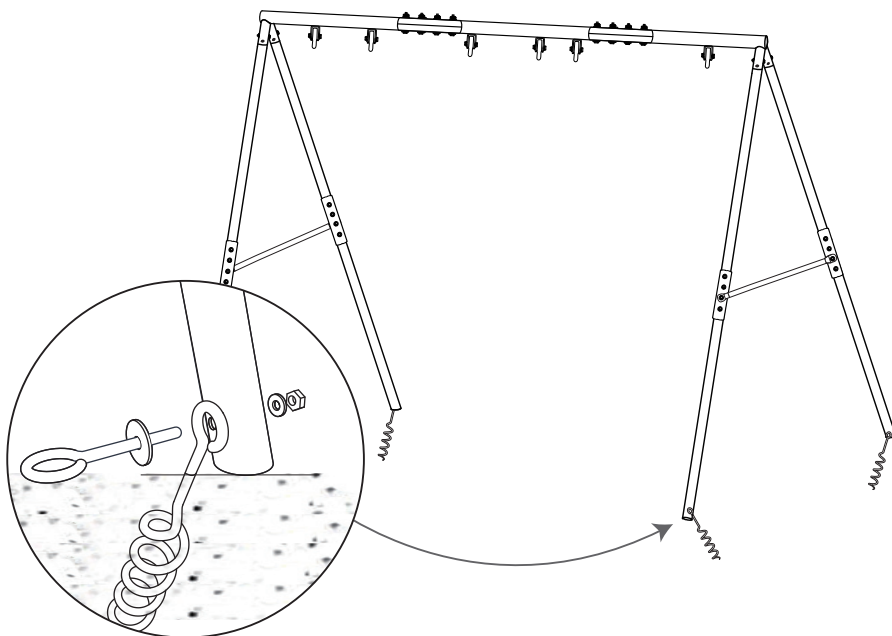

**Step7: Install the platform swing**

1. Insert 4 Tubes into the swing seat.
2. Connect two joints at the left side of swing,make sure two holes align.
3. Align the pipe ends at the right side of swing,then push down the short tube gently until it is even.

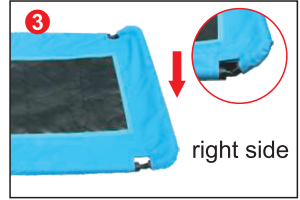
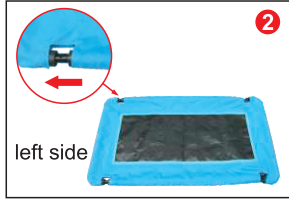

4. Insert the bolt into the hole at the front side swing.
5. Put the washer and nut onto the bolt, and tighten with a wren until 3-4 threads of bolts are exposed, then put the nut cap onto the bolt and tighten it. Please make sure all the screws are tightened for your safety. (You need a wrench to fasten nut and nut cap.)
6. Assembly complete.



**Step8: Attach the belt swings to the A1 tube and B tube, and hang the platform swing to the A2 tube.**

