

# Assembly Instruction

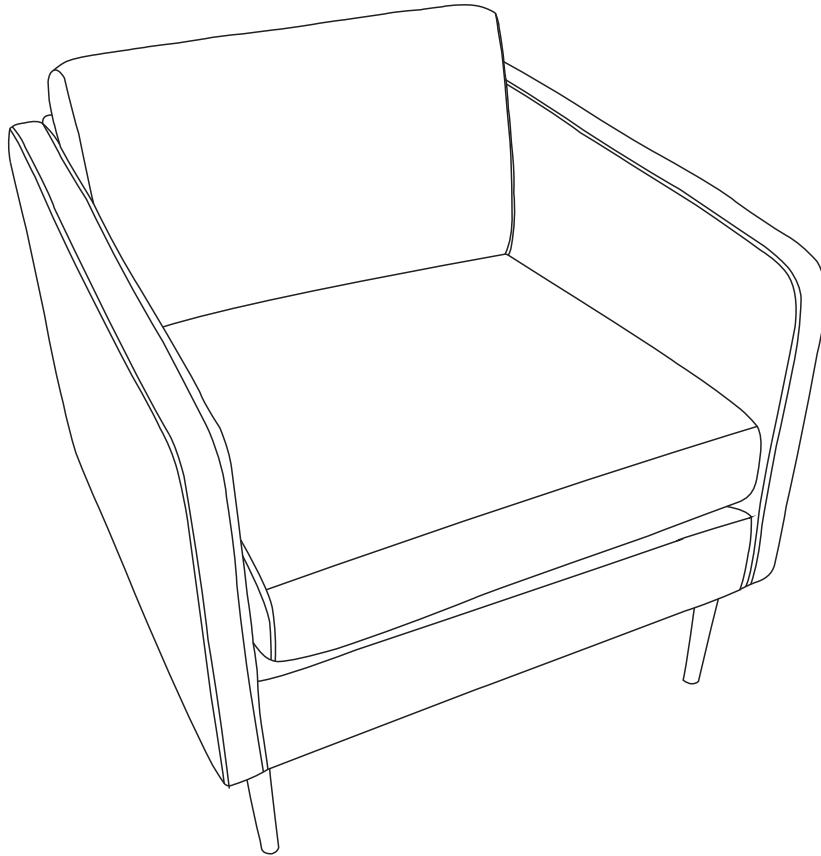

**Attention:** Do not open the compression bag if you are not satisfied with the product









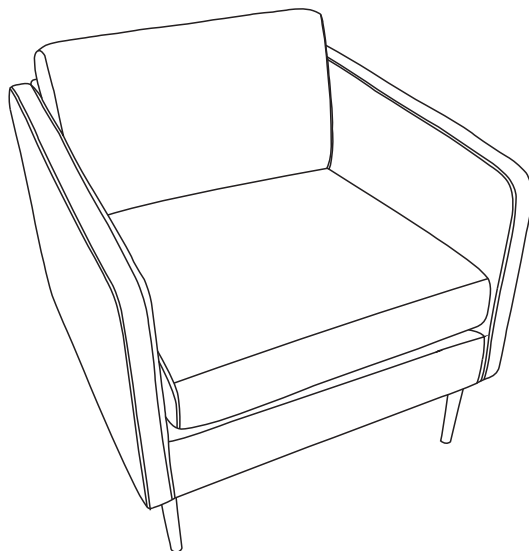
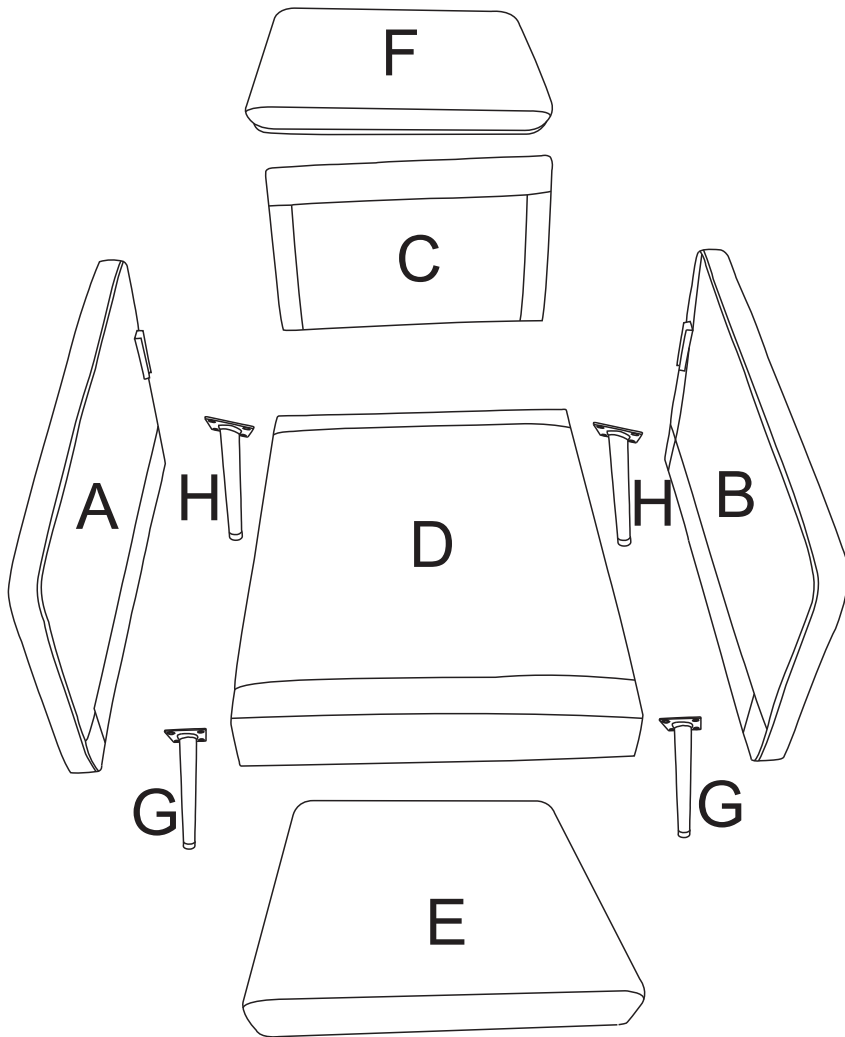

Thank you for your purchase.

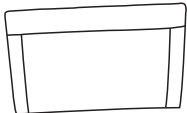
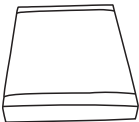
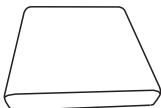
If you have difficulty with assembly or find a part is missing or damaged, please don't hesitate to contact us for solution.

Customer Service team will work hard to put a smile back on your face.

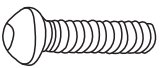
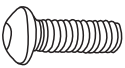
# Components

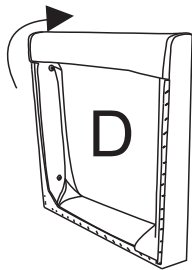

NO	PARTS	QTY	DESCRIPTION
A		1 PC	Left Arm-rest frame
B		1 PC	Right Arm-rest frame
C		1 PC	Back frame
D		1 PC	Seat frame
E		1 PC	Seat Cushion
F		1 PC	Back Cushion
G		2 PCS	Front Leg
H		2 PCS	Back Leg
I		4 PCS+1	M8*60mm Screw
J		16 PCS+2	M6*25mm Screw
K		4 PCS+1	M8*12 Spring Washer
L		4 PCS+1	M8*22 Flat Washer
M		1 PC	Allen Key

**STEP 1**

Open the seat and take out the accessory



C\*1



F\*1



G\*2



H\*2

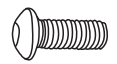

I\*4+2

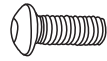

J\*16+2



K\*4+1



L\*4+1



M\*1

**STEP 2**

Connect Seat frame D to handrail A with screw I

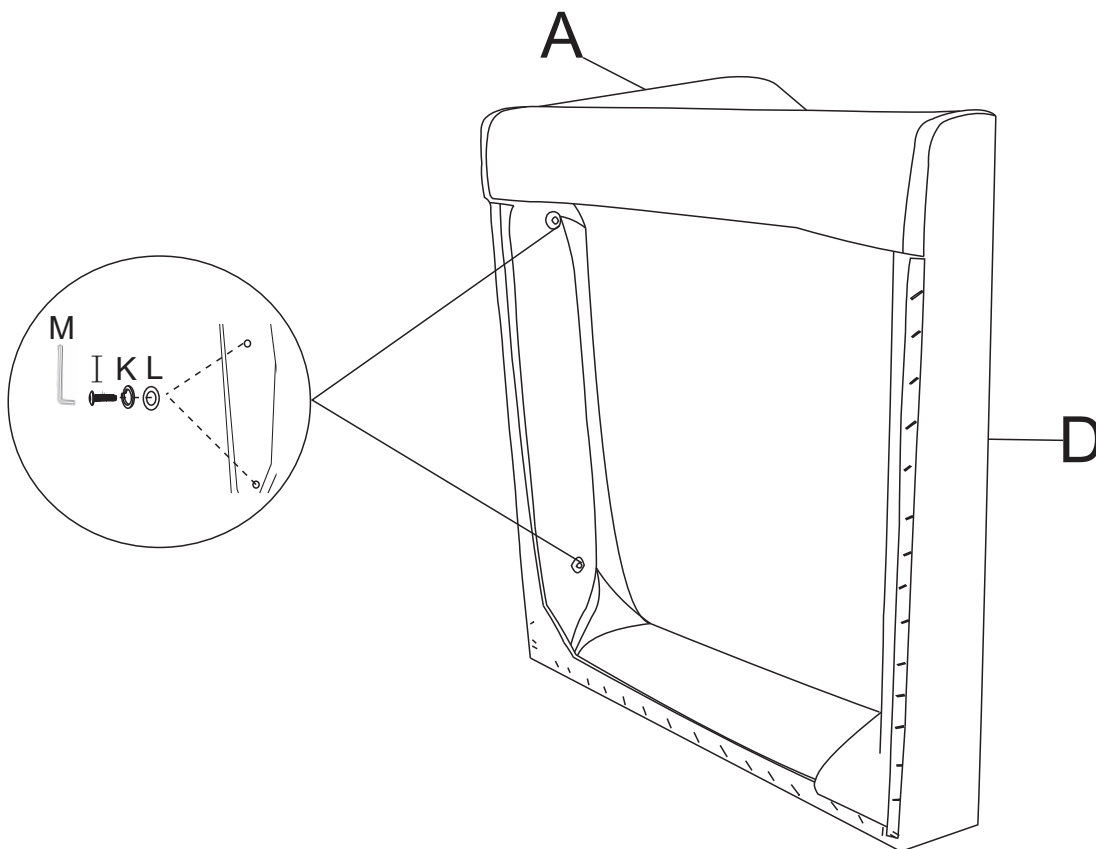

**STEP 3**

Connect Seat frame D to handrail B with screw I

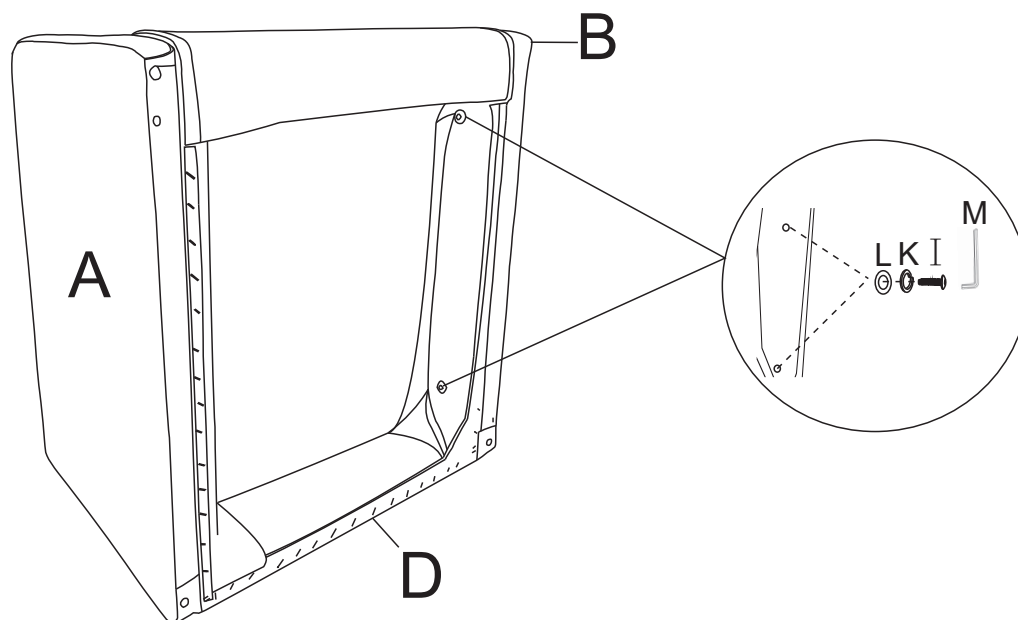

**STEP 4**

put in C, Link as shown

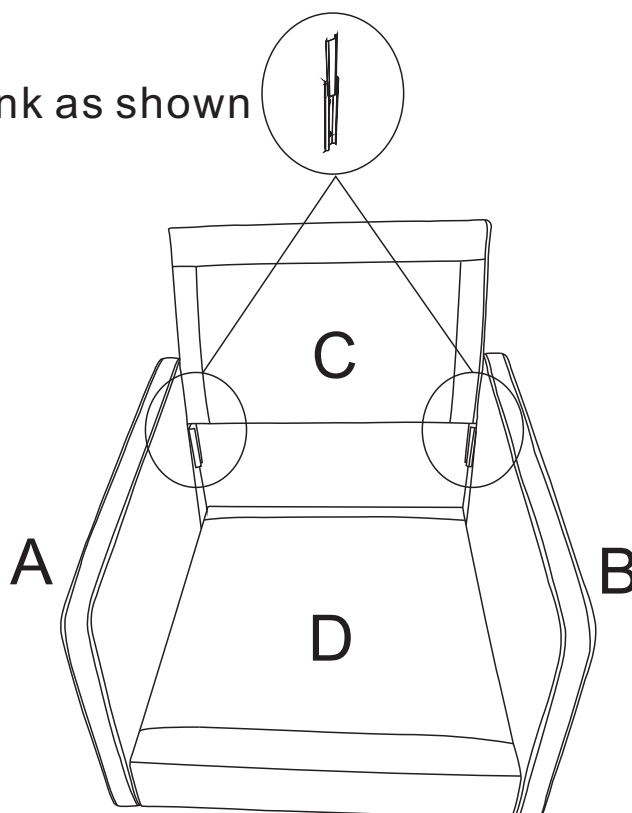

## STEP 5

Secure the Leg G/H and Seat frame D with screw J  
( Attention:Distinguish between front and back leg )

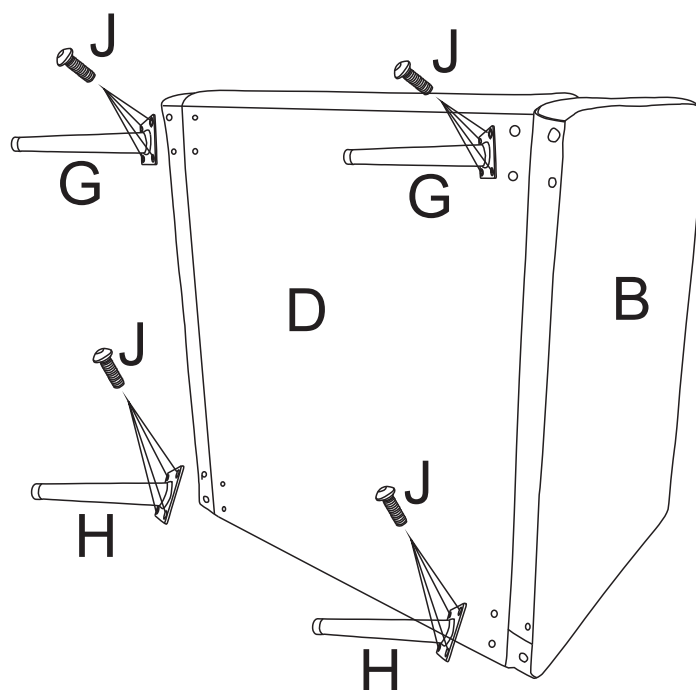

## STEP 6

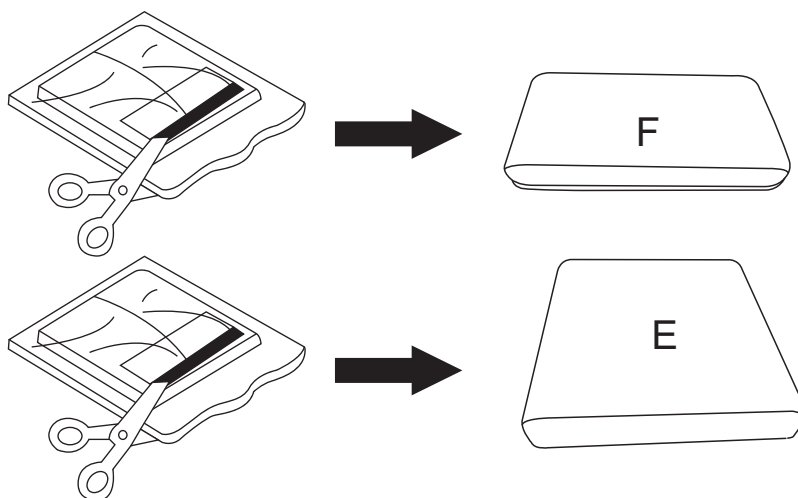

1. Cut open the compression package and remove the seat cushion and back cushion
2. Compression package after cutting, after standing for 24 hours, more comfortable

**STEP 7**

Have cushion F and E placed respectively

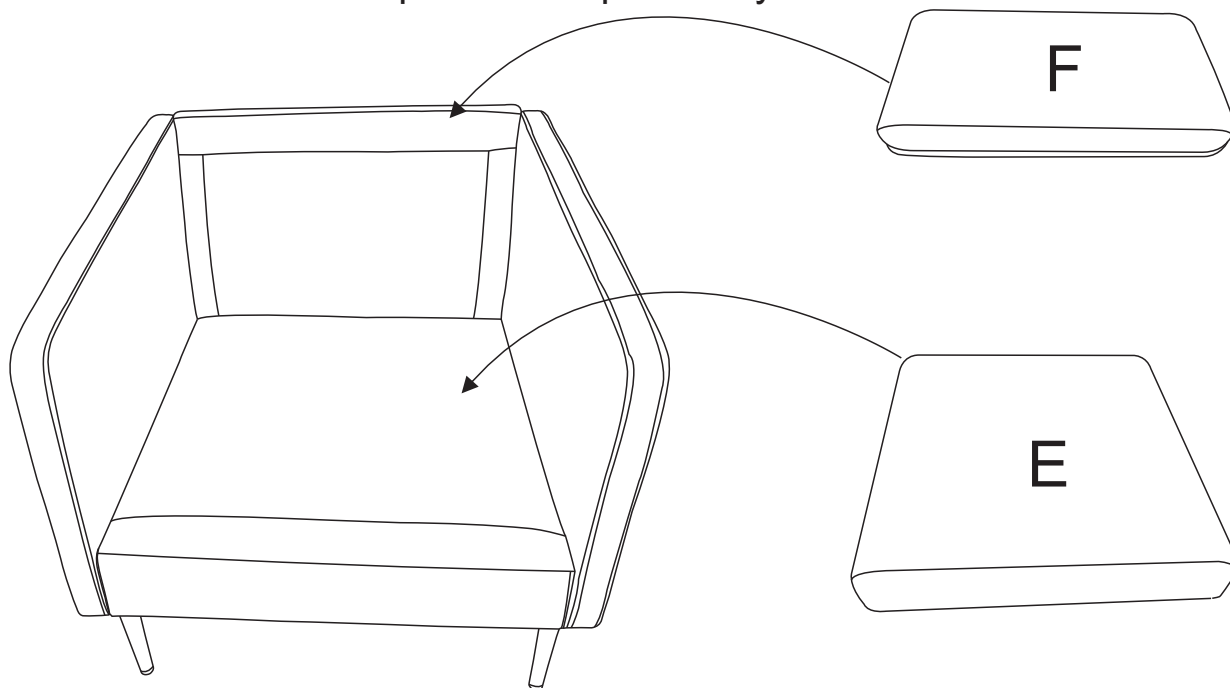

**STEP 8**

Well done!

