

A PERSONAL MESSAGE FROM OUR FOUNDER

When I shop, I am not just buying a product or service. I purchase why that brand focuses on what they do, what their corporate philosophy is, the quality of their products, and whether or not my personal core values align with that brand's vision. When I don't feel great about a company's brand, products, or how I'm being treated as a customer, then I know they are not delivering on what matters most: exceeding the customer expectation by delivering happiness with their products, quality, and service.

This primary focus is what drives our culture at Team Skybound. For supporting our vision, we would like to personally thank you for trusting us to deliver happiness to you and your family!

-Kiki (Founder) & Team SkyBound

"Nurturing the inner-child in all of us by uniting communities worldwide and promoting an active lifestyle."

For customer service, please contact:

888-891-4689

Monday through Friday
8:00 am to 5:00 pm PST

or visit www.SkyBoundUSA.com
or www.TrampolinePartsCenter.com



help@skyboundusa.com

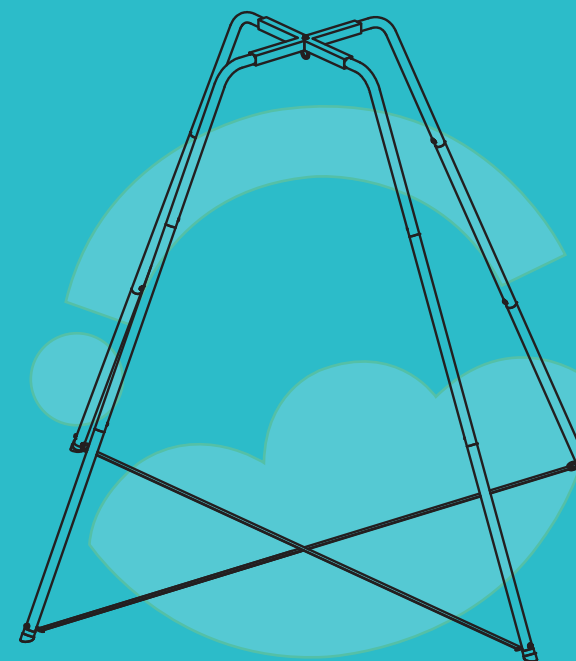

SWING SET FRAME











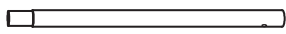
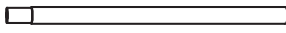
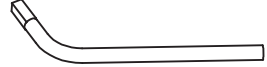
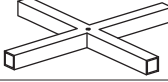

ASSEMBLY AND INSTALLATION MANUAL

www.SkyBoundUSA.com
www.TrampolinePartsCenter.com

IMPORTANT INFORMATION

WARNING

This object is subject to wear and tear. No warranties whether expressed or implied are provided.
 Injury will likely occur with the use of a trampoline or any associated product.
 Use with supervision. Use at your own risk.
 Only Use in a well-lit, well secured down area.

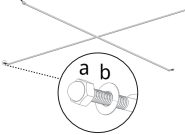
NO.	Part Name	Pictures	Quantity
0	M10 Wrench		1
1	Wrench		1
2	L Shaped Wrench		1
3	Frame Foot		4
4	Bottom Feet Tube		4
5	Middle Frame Tube		4
6	Upper Frame Tube		4
7	X-Frame		1
8	Bolt		12
9	M8 Washer		12
10	M8 Spring Washer		12
11	M10 Nut		1
12	M10 Washer		1
13	M10 Ring Bolt		1
14	Carabiner		1
15	Rope		1

ASSEMBLY INSTRUCTIONS

INSTALLATION STEPS OF SWING SET FRAME

STEP 1

Attach frame tube (4, 5, 6) and fixed by bolt (8, 9, 10).

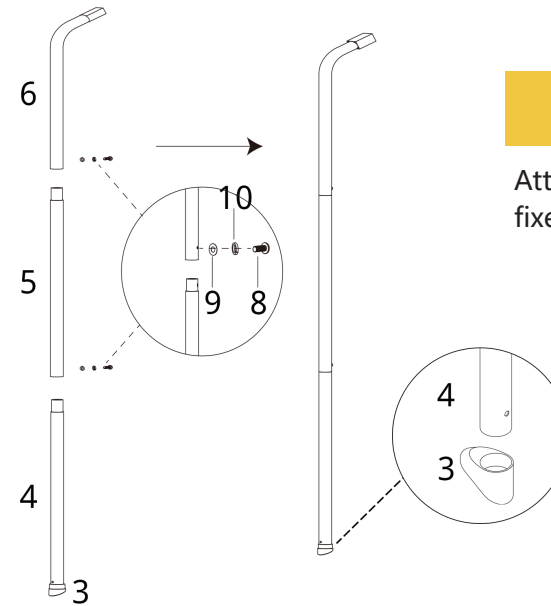

STEP 2

Attach frame tubes to X-Frame and insert hardware (8, 9, 10) as shown in the figure.

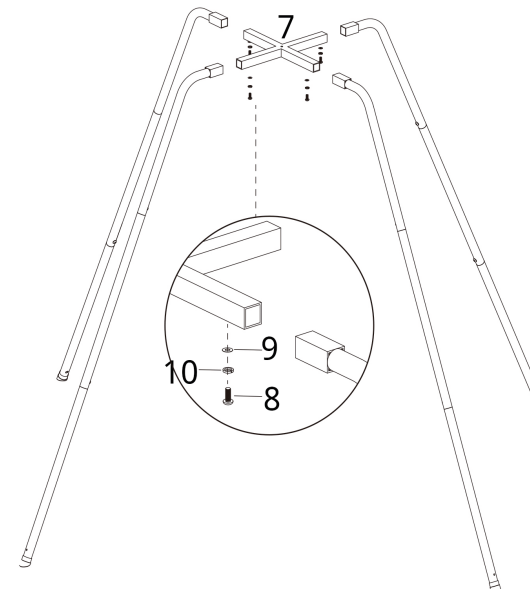

ASSEMBLY INSTRUCTIONS

INSTALLATION STEPS OF SWING SET FRAME

STEP 3

Fix the ring bolt (13) and carebiner (14) on the top.

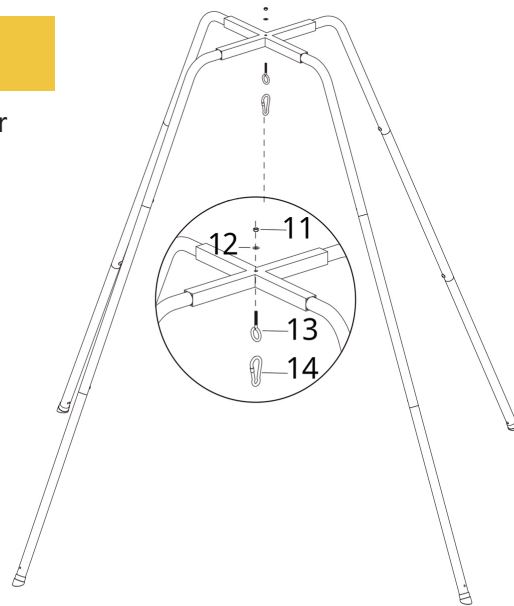

STEP 4

Fix the nut (a, b) to the rope (15) on the feet.

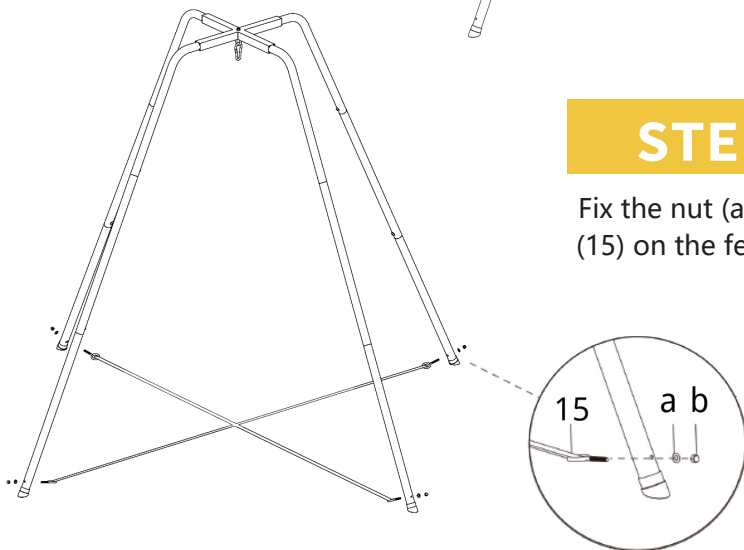

ASSEMBLY INSTRUCTIONS

INSTALLATION STEPS OF SWING SET FRAME

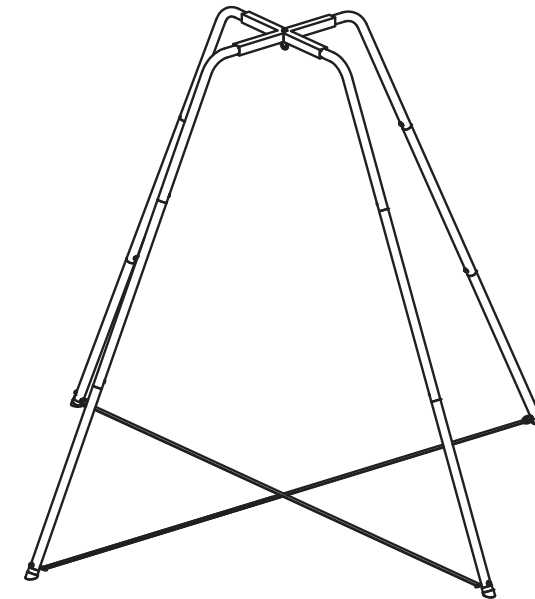

Installation completion drawing

SkyBoundUSA.com

(888) 891-4689

SkyBound Customer Service
help@skyboundusa.com



SkyBound, a BX International Inc Company.
SkyBound is a registered trademark of BX International Inc.
in the U.S. and other countries. All logos, names,
characters, likenesses, images, slogans and
packaging appearance are the property of SkyBound.