

ASSEMBLY INSTRUCTIONS

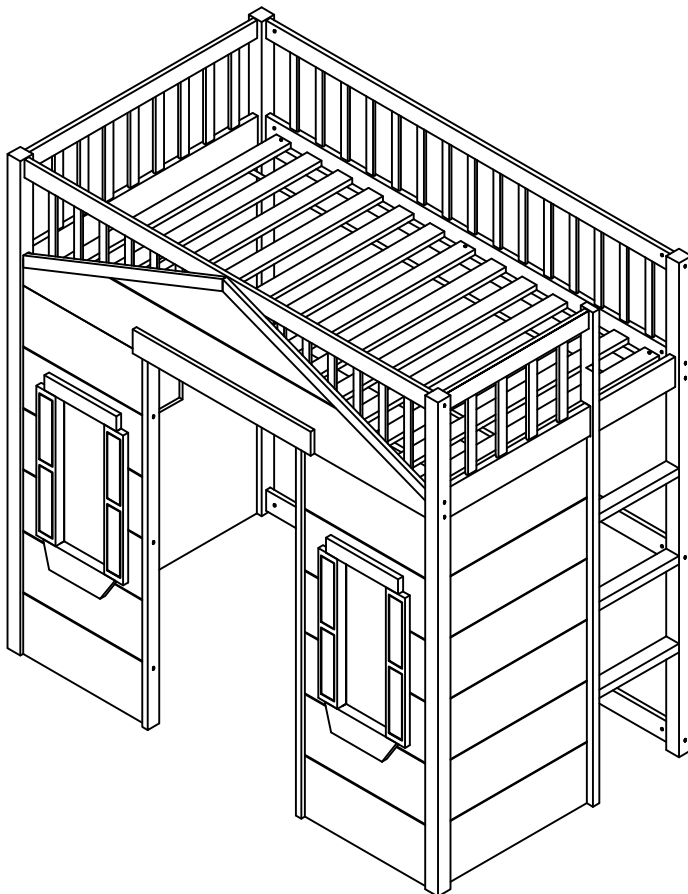

TOOLS REQUIRED



Allen Wrench

(Included)



Phillips
Screwdriver

(Not Included)



3- People
Recommended

ASSEMBLY RATING



EASY —————> DIFFICULT

The Assembly Rating is a 5-point system showing the level of effort needed to assemble a specific product.

Thank you for your purchase!

We hope you enjoy this new addition to your home for many years to come.



CHECK BEFORE STARTING

Are you missing anything?

Double-check all parts, hardware and accessories listed on Page 6 are accounted for.

Check out our Quick Tips!

We recommend reviewing the pre-assembly handouts. Even experts need a refresher now and then!

Should we send any replacements?

Are there any irregularities or flaws in the parts? We can send replacements!

Prep Time!

Please review the assembly instructions and all diagrams prior to assembling. Arrange parts as recommended on Page 7 and group identical hardware together to make assembling easier.

PRE ASSEMBLY INTRODUCTION

We understand building ready-to-assemble furniture can be a challenging experience for some. To help avoid confusion, we have provided some helpful tips that may speed up the process.

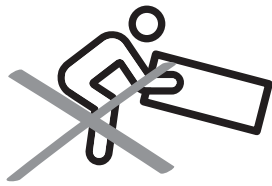

Teamwork

ALWAYS have at least two people to help with transporting and assembling the product to avoid potential injury and/or damage.



Suitable Location

Assembling near the area of the intended location is highly recommended.



Sufficient Space

Make sure you have enough space to move around during the assembly.



Avoid Scratches

Use cardboard, blankets or a carpeted area while assembling furniture to prevent scratches.



Flat Surface

Make sure the furniture rests on a flat and level surface with each leg evenly touching the floor.

ASSEMBLY AND CARE ADVICE



FAILURE TO FOLLOW THE GUIDELINES BELOW MAY RESULT IN INJURY AND/OR PROPERTY DAMAGE.



Position each part correctly and insert screws or bolts into their respective holes.

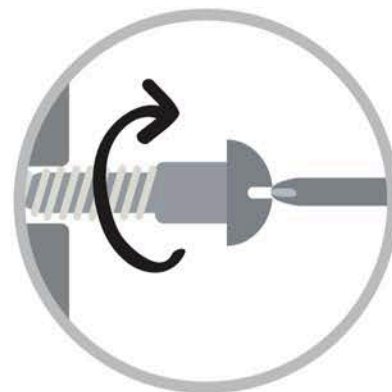

Turn clockwise to tighten and only tighten when step is completed or when instructed to do so.



Use the appropriate hand tools or power tools for assembly. Select steps, such as tightening screws and/or bolts, may require hand tools to avoid causing damage during assembly.



Save the instructions and store any supplied tools for later maintenance.



After two weeks, check and tighten any loose hardware and repeat again every six months thereafter.

IT IS THE USER'S RESPONSIBILITY TO MAINTAIN THE FURNITURE. THE HARDWARE MAY LOOSEN OVER TIME AND MAY CAUSE THE FURNITURE TO BE WOBBLY AND UNABLE TO SUPPORT ITS INTENDED WEIGHT CAPACITY. THIS MAY LEAD TO COLLAPSE AND MAY CAUSE SERIOUS INJURY.

DAYBED

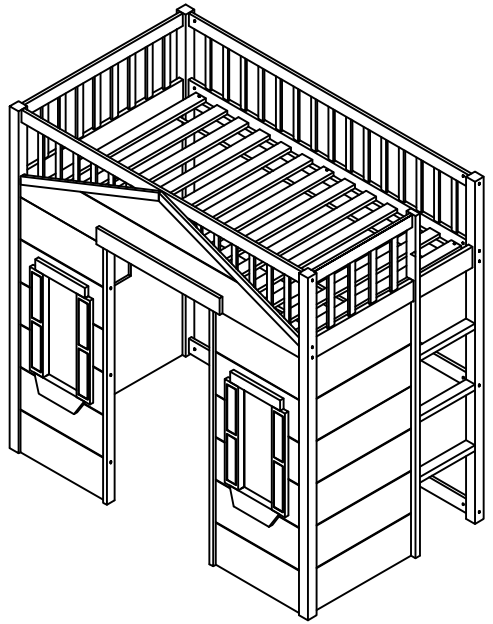

• Please keep instructions for future reference.
 • Check the quantity and irregularity of parts and hardware before you start.

PARTS

#1 1pc

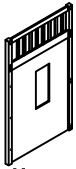

Headboard (L)

#2 1pc

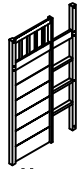

Headboard (R)

#3 1pc

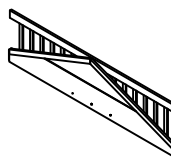

Upper Front Side Rail

#4 1pc

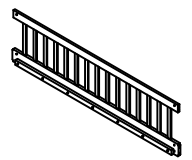

Upper Front Side Rail

#5 2pcs

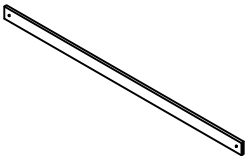

Lower Guardrail

#6 1set

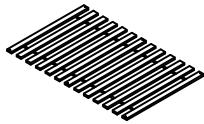

Twin Slats Kit (13pcs)

#7 2pcs

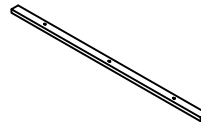

Vertical Bar

#8 1pc



Frames (L)

#9 1pc

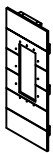

Frames (R)

#10 1pc



Crossbar

#11 2pcs



Window

#12 4pcs



Window

#13 2pcs



Window

HARDWARE

#A 16pcs



Bolt
Ø1/4" x 4-3/8"

#B 16pcs



Barrel Nut
Ø1/4" x 1/2"

#C 18pcs



Bolt
Ø1/4" x 1-3/8"

#D 16pcs

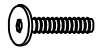

Bolt
Ø1/4" x 1"

#E 12pcs



Wood Dowel
Ø10x40mm

#F 1pc



Wood Dowel
Ø10x30mm

#G 8pcs



Wood Dowel
Ø10x20mm

#H 6pcs



Screw
#4 x 30mm







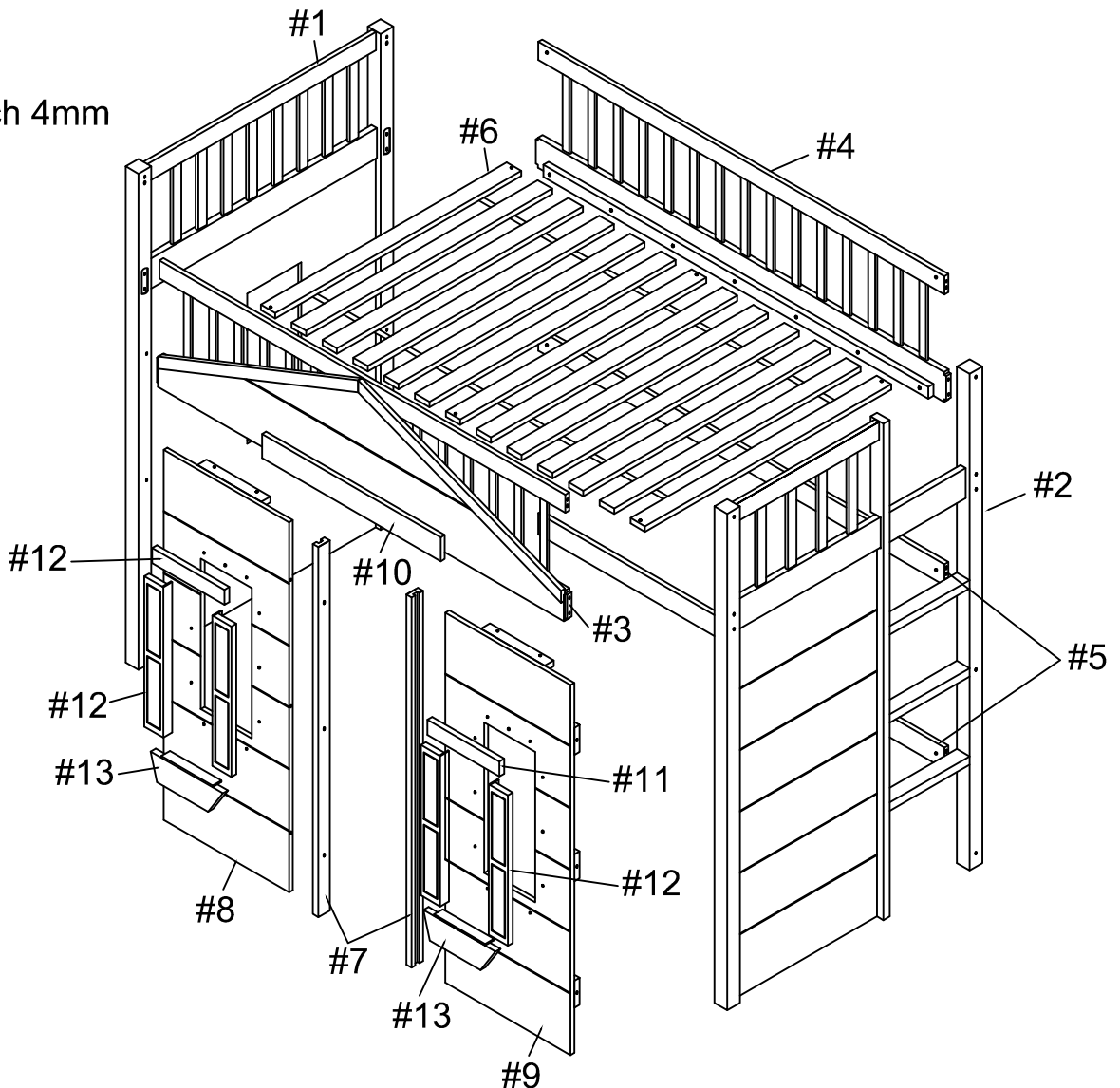



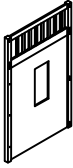
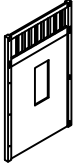
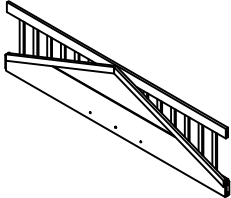

#I 1pc





Allen Wrench 4mm

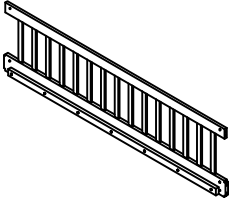
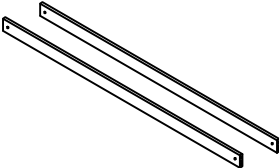
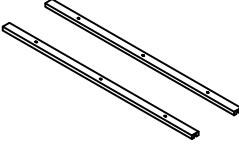

packed in 3 cases

Carton	Disignation	Part	Part	Hardware
	Heardboard (L)	#1		
	Heardboard (R)	#2		
	Upper Front Side Rail	#3		 #A x 16pcs  #B x 16pcs  #C x 18pcs  #D x 16pcs  #E x 12pcs  #F x 1pc  #G x 8pcs  #H x 6pcs  #I x 1pc
	Upper Back Side Rail	#4		
	Lower Guardrail	#5		
	Vertical Bar	#7		
	Crossbar	#10		

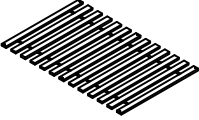
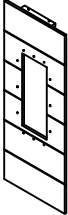
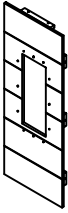
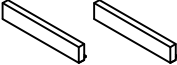
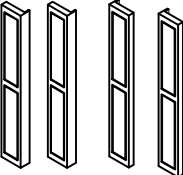
packed in 3 cases

Carton	Disignation	Part	Part	Hardware
<p>-----</p>	Twin Slats Kit (13pcs)	#6		
	Frames (L)	#8		
	Frames (R)	#8		
	Window	#11		
	Window	#12		
	Window	#13		

ASSEMBLY INSTRUCTIONS

1

- Part #1 x 1pc
- Part #2 x 1pc
- Part #3 x 1pc
- Part #4 x 1pc
- Part #5 x 2pcs
- Hardware #A x 16pcs
- Hardware #B x 16pcs
- Hardware #E x 12pcs

1) Insert dowels (#E) and barrel nuts (#B) to each ends of the side rails (#3,4). Align Side rails (#3,4) to the holes on the top of the headboards (#1,2). Secure by screwing bolts (#A) onto the barrel nuts (#B) of the side rails (#3,4).

2) Attach dowels (#E) and barrel nuts (#B) to each ends of the guardrails (#5). Align guardrails (#5) to the holes of the headboards (#1,2). Secure by screwing bolts (#A) onto the barrel nuts (#B) of the guardrails (#5).

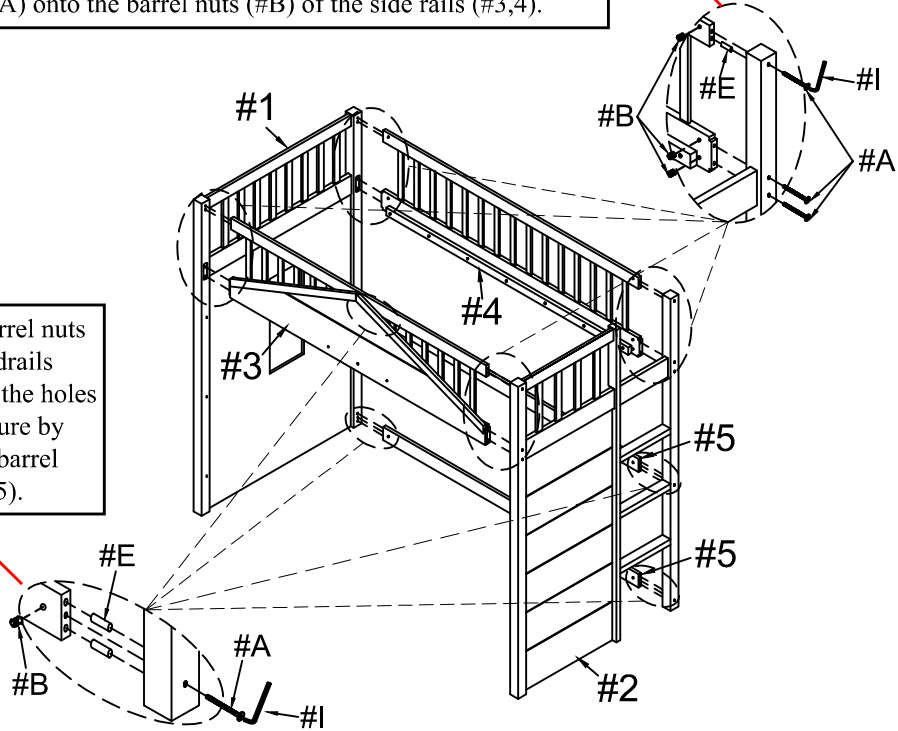

2

- Part #7 x 2pcs
- Part #8 x 1pc
- Part #9 x 1pc
- Hardware #C x 6pcs

1) Align vertical bar (#7) to the right side holes of the frame (#8). Secure by using bolts (#C).
 2) Align vertical bar (#7) to the left side holes of the frame (#9). Secure by using bolts (#C).

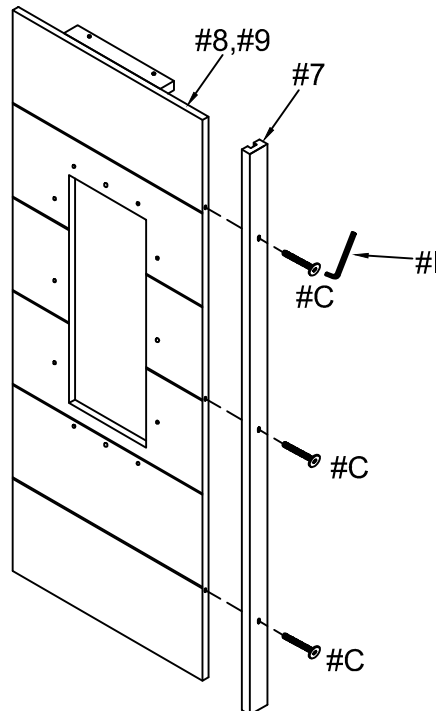

X2

ASSEMBLY INSTRUCTIONS

3

Hardware **#C** x 10pcs

1) Align frames (#8,9) to the holes of the upper guardrail. Secure by using bolts (#C).

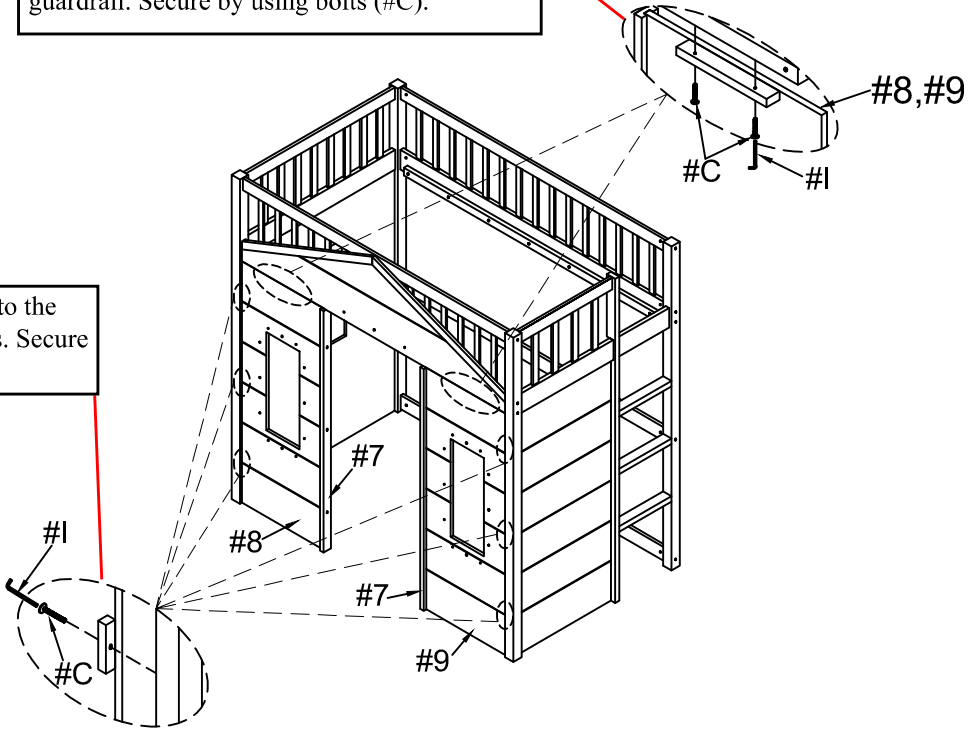

2) Align frames (#8,9) to the holes of the headboards. Secure by using bolts (#C).

4

Part **#11** x 2pcs
Hardware **#D** x 4pcs
Hardware **#G** x 2pcs

Insert dowels (#G) to the center hole of the window panel (#11). Attach window panel (#11) to the top holes of the window, then secure by using bolts (#D).

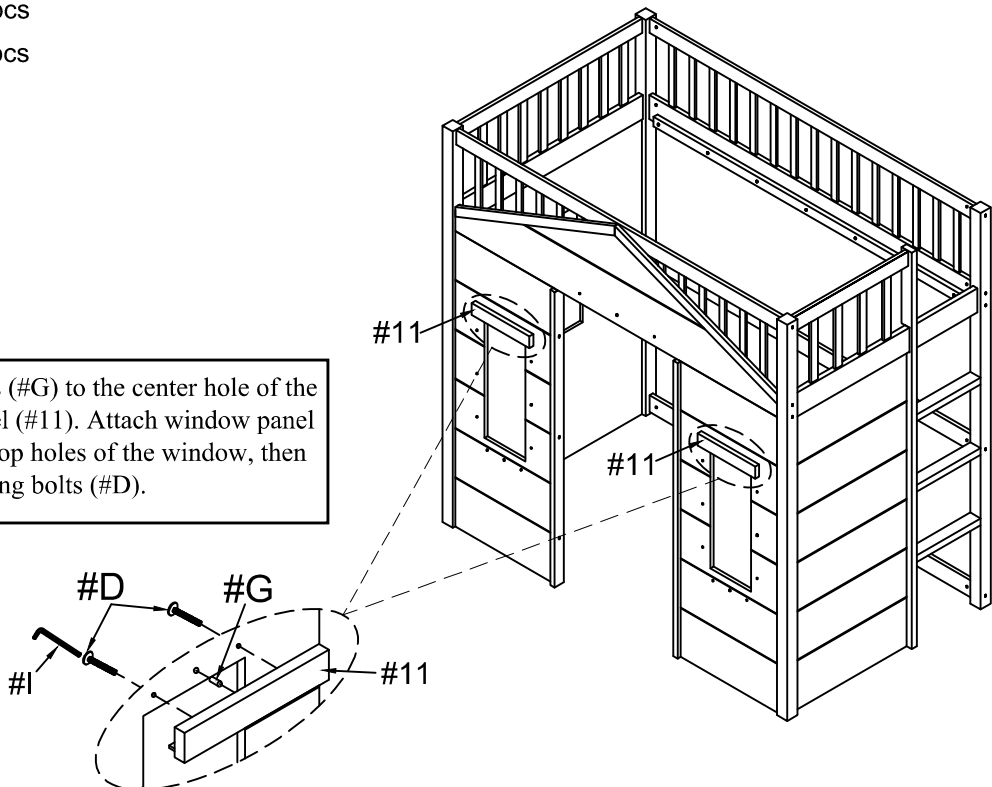

ASSEMBLY INSTRUCTIONS

5

- Part #12 x 4pcs
- Hardware #D x 8pcs
- Hardware #G x 4pcs

Insert dowels (#G) to the center hole of the window side panel (#12). Attach window side panel (#12) to the side holes of the window, then secure by using bolts (#D).

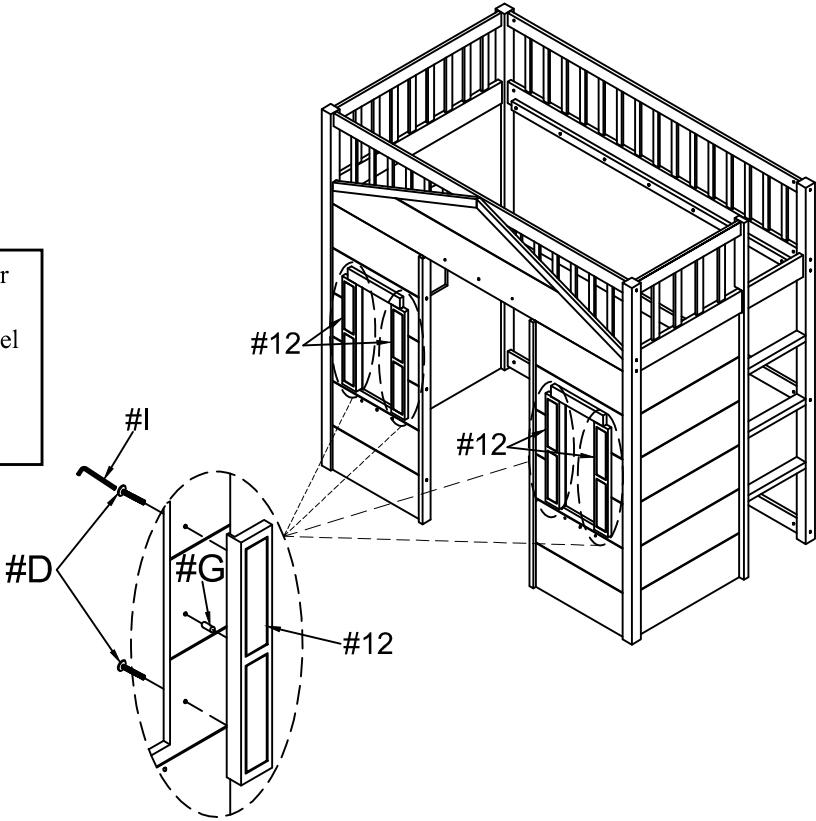

6

- Part #13 x 2pcs
- Hardware #D x 4pcs
- Hardware #G x 2pcs

Insert dowels (#G) to the center hole of the window bottom panel (#13). Attach window bottom panel (#13) to the bottom holes of the window, then secure by using bolts (#D).

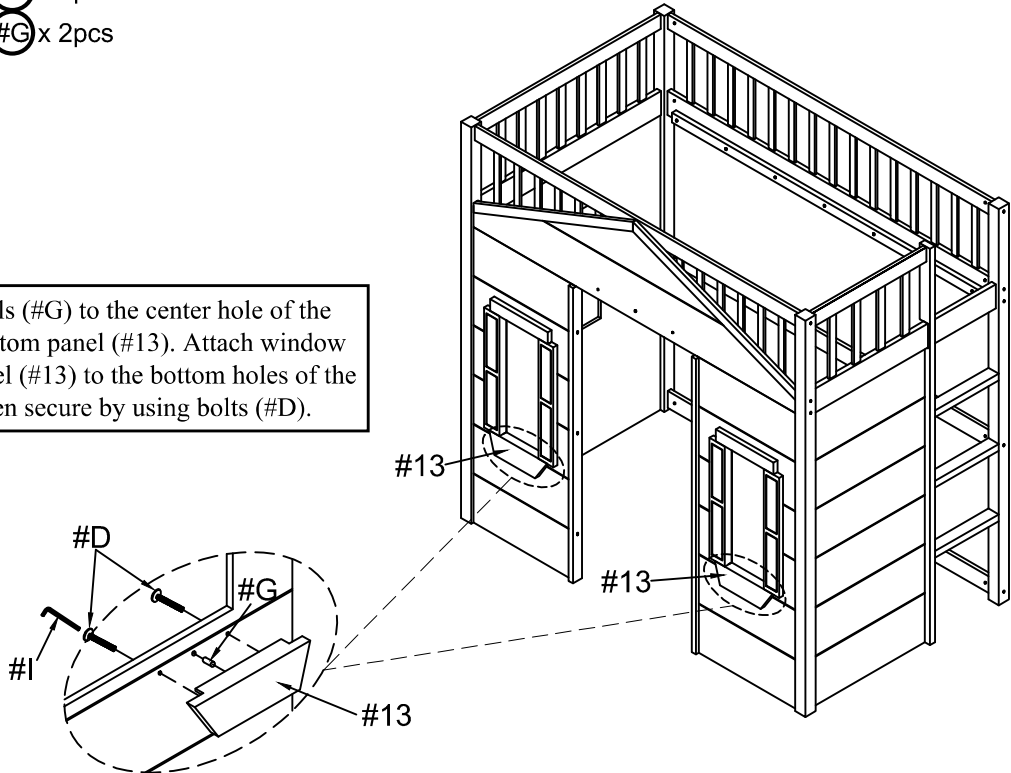

ASSEMBLY INSTRUCTIONS

7

Part **#10** x 1pc
Hardware **#C** x 2pcs
Hardware **#F** x 1pc

Insert dowels (#F) to the center hole of the door crossbar (#10). Attach door crossbar (#10) to the top holes of the door, then secure by using bolts (#C).

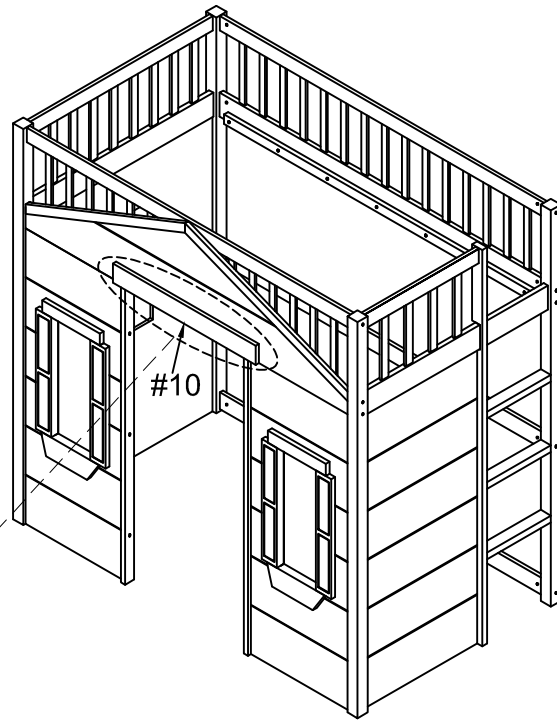
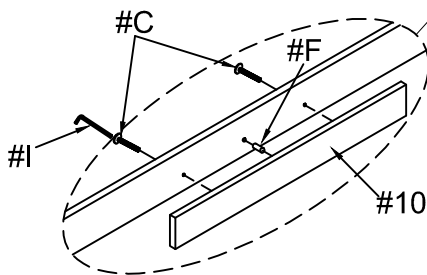

8

Part **#6** x 1set
Hardware **#H** x 6pcs

Align slat kit (#6) to the top of the bunk, then secure by using screws (#H).

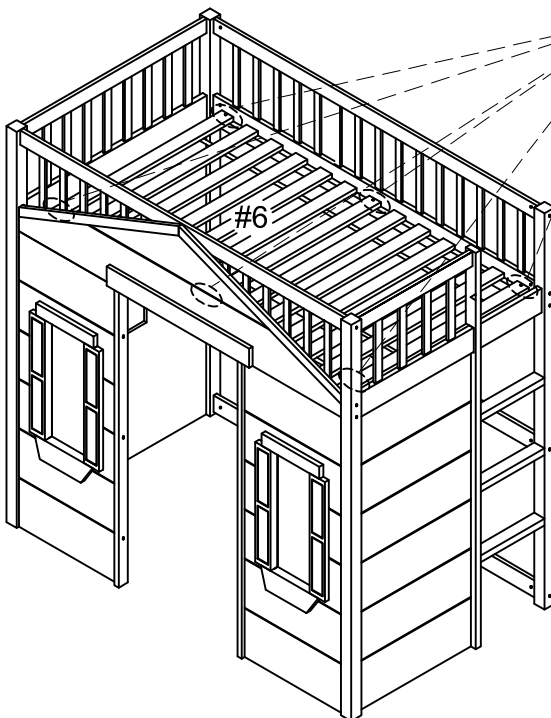
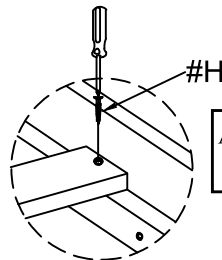

ASSEMBLY COMPLETED



Please ensure the furniture rests on an even and flat surface. If the product wobbles or feels loose, double-check all bolts and/or screws are properly tightened and secured.

✓ Keep this handy!

Please retain this instruction manual and any order-related information for future reference.

✓ Lift, don't drag!

To avoid damage to product please always LIFT the product when transporting or adjusting the placement.

Safety Warnings for Bunk Beds

1. Read and follow the information on the WARNINGS shown on the end structure of the upper bunk and on the carton.
2. Do not remove warning label from the bed.
3. Keep these instructions for future reference.
4. **IMPORTANT: Must use Bunkie mattress or Bunkie board.** The proper sizes for the **UPPER/LOWER TWIN-SIZE** Bunkie mattress or Bunkie board should be 74" long and 37½" - 38½" wide with no more than 6" thickness and for the **UPPER/LOWER FULL-SIZE** should be 74" long and 53" - 54" wide with no more than 6" thickness.
5. Surface of mattress must be at least 5 inches (127 mm) **BELOW** the upper edge of guardrails.
6. The **MAXIMUM** weight capacity for the upper bunk is not to exceed 175 lbs.
7. Do not allow children under 6 years of age to use the upper bunk.
8. Periodically check and ensure that the guardrails, ladder, handle and other components are in their proper position, free from damage, and that all connectors are tightened and secured.
9. **DO NOT** allow horseplay, rough playing or jumping on the beds and do not allow playing or hiding under the beds.
10. Always use the ladder for entering or leaving the upper bunk.
11. Do not use substitute parts. Contact the manufacturer or dealer for replacement parts.
12. Use of a nightlight may provide added safety precaution for a person using the upper bunk.
13. Always use the guardrails on both sides of the upper bunk.
14. If the bunk bed will be placed next to a wall, the guardrail that runs the full length of the bed should be placed against the wall to prevent entrapment between the bed and the wall.
15. The use of water or sleep flotation mattresses is prohibited.
16. No more than one person is allowed on the upper bunk at all times.



WARNING: STRANGULATION HAZARD

Never attach or hang objects to any part of the bunk bed that are not designed for use with the bed. Objects such as hanger, hook, belt, bag, rope, string, etc. should not be used on or around the bunk bed.