

Industrial Pipe Clothing Rack CR1-1T-39

User Manual ▶

<https://gwhfactory.com/>

Important safety instructions:

- Proper installation of the mounting hardware for this item is highly recommended.
- Do not stand, step, or swing on the unit.
- Do not tighten bolts/ screws completely until all bolts/ screws are lined up and inserted into holes.
- Do not over tighten bolts/ screws to avoid stripping.
- Please use hand tools to assemble this product.

TO GUARANTEE THE SAFE USE OF THIS PRODUCT, FOLLOW THE WARNINGS, GUIDELINES AND RECOMMENDATIONS IN THIS MANUAL.

Hello DIY Lovers,

I know how excited you are to roll up your sleeves and get to work right away, but taking a few seconds to read me can save you some installation time. I swear it only takes about 15 minutes as long as you follow the instructions exactly and the gravity where you live is still working. Don't worry, follow these simple instructions and you'll come back to your lover in no time.

All you need is ...

- A cup of coffee
- A motivational playlist
- Basic installation skills, so you can use these hand tools:



1. 1 Measuring tape



2. 1 Pencil (borrow your kid)



3. 1 Driller (make sure your wall can be drilled)



4. 1 Screwdriver



1 Spirit Level Ruler (optional)

LET'S GET STARTED!

This is what a successfully installed Clothing Rack should look like.

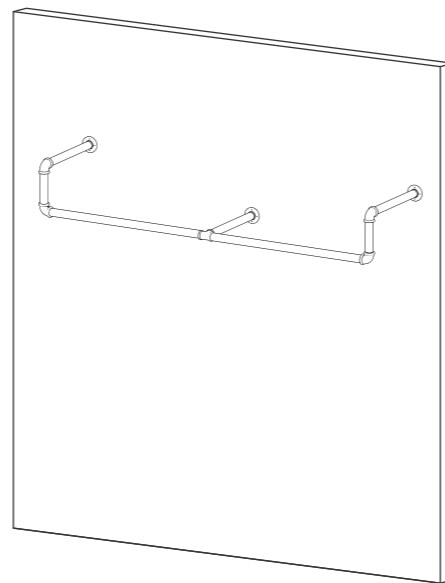

Estimated time for assembly



The order of work to do is:

1. Assemble the pipes (5 min)
 2. Attach the pipe to the wall (10 min)
- It's easy, right?

Below are the parts that are already included in the kit.

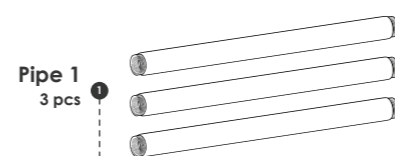

Pipe 1
3 pcs

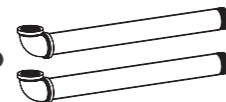

Short Pipe + Elbow
2 pcs

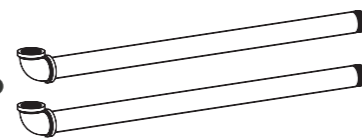

Long Pipe + Elbow
2 pcs



Tee
1 pcs



Flange
3 pcs



Long Screw
12 pcs



Plastic Dowel
12 pcs

1. Assemble the Pipes

Step 1: Assemble 1 bracket at a time. Twist the pipes (1) to attach to Flange (5). Then we have 3 brackets (A). Note: rotate clockwise

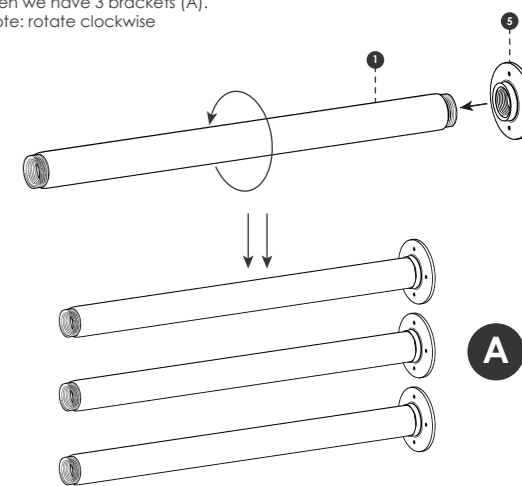

Step 2: Twist the Long Pipes + Elbow (3) to attach to Tee (4). Note: rotate clockwise

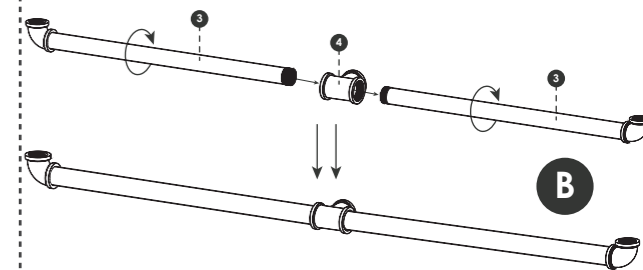

Step 3: Twist the Short Pipes + Elbow (3) to B Note: rotate clockwise

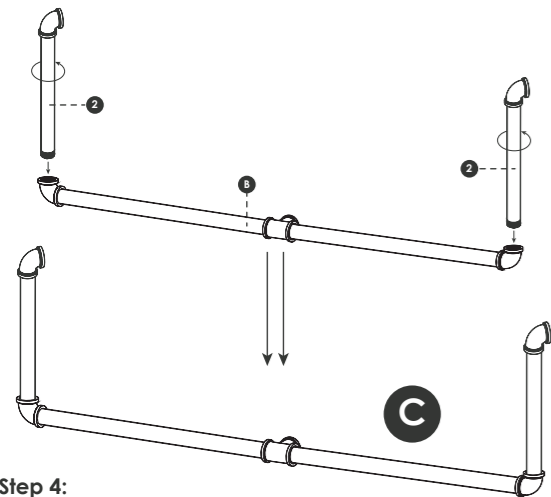

Step 4: Twist the Bracket (A) to C Note: rotate clockwise

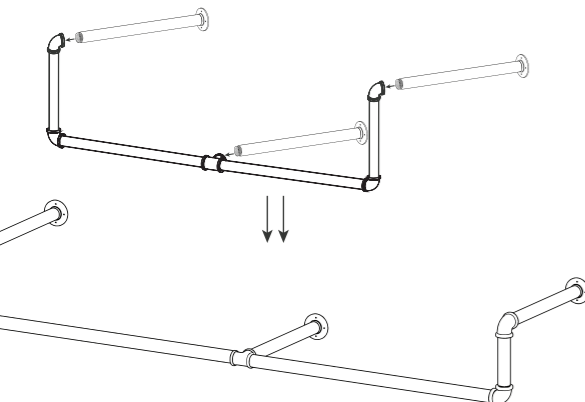

2 Tips to keep 2 brackets at the same height and aligned:

Tip 1: Use a spirit level ruler to draw a line parallel to the ground

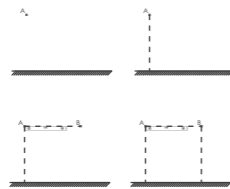

Tip 2: Use the properties of rectangles to draw a line parallel to the ground

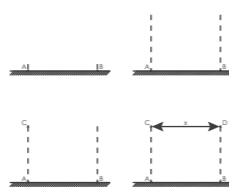

1. Determine the height of the shelf and mark 1 point (Point A) on the wall

2. From Point A, draw a line perpendicular to the ground (Line A)

3. From point A, use a spirit level ruler to draw a line perpendicular to line A, which is parallel to the ground (Line A1)

4. On-Line A1, locate point B so that AB = the suitable size

5. From Point B, draw a line perpendicular to the ground (Line B)

6. Place brackets on Line A and Line B, which were drawn earlier.

1. Determine 2 points A and B on the ground so that AB= X (the suitable size)

2. From A, draw a line perpendicular to the ground on the wall, we have Line A. On-Line A, choose a point (C) so that AC is the desired height of the Rack.

3. From B, draw a line perpendicular to the ground on the wall, we have Line B. On-Line B, choose a point (D) such that CD = AB (use measuring tape)

4. Place 2 brackets on AC and BD, which were drawn earlier.

2. Attach to the wall.

Step 1: Measure the perfect height using the measuring tape.

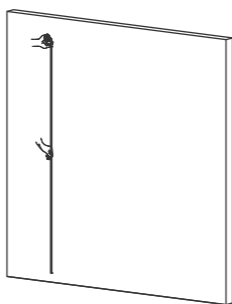

Step 2: Place the rack on the wall fit to the height you wanted.

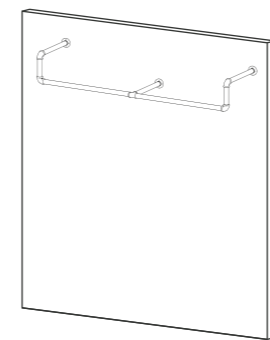

Step 3: Use a pencil to mark 4 Flange holes.

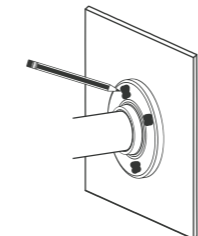

Step 5: Use the handle of the screwdriver to knock dowels into the previously drilled holes

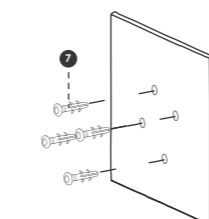

Step 4: Drill 4 holes for each Flange.

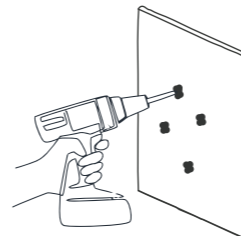

Step 6: Use a screwdriver to drive 4 screws into 4 Flange holes and 4 dowels.

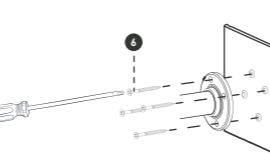

3. Start hanging your clothes.

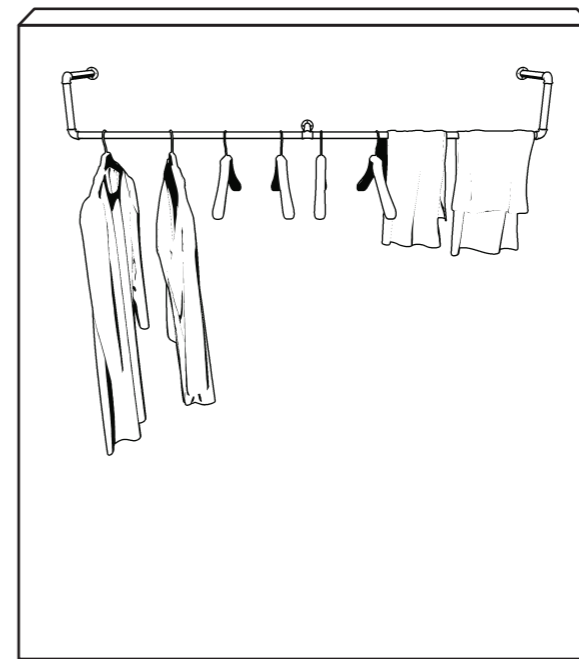

"Ta-da!" You've done a good job!

Order a celebratory pizza, you deserve it! ... Oh. I think your lover is waiting for you.

We really don't want you to go through the hassle of re-packaging your item and sending it back, because let's be honest...nobody has time for that. ☺☺☺

Instructions for use and maintenance:

1. We recommend that you tighten the screws 2 weeks after assembly and for added safety check the tightness of all screws every 2 months.
2. DO NOT leave children unattended before the product is fully assembled.
3. We do not recommend the use of chemical cleaners, abrasives, or furniture polish on our lacquered finish.

Use this product responsibly with the primary concern for your safety. Follow assembly instructions carefully and inspect the product upon receipt and each use.

Warranty Information

If you have any questions or issues with the product, please contact us through the Amazon store and our website. We have a return policy if the product is defective or does not meet your expectations. Please contact us to get the most suitable solution.

Hope you will have interesting experiences with our Clothing Rack. The instructions above are recommended for a standard shelf with stable gravity on Earth. You are sure to find something you'll love in our selection of rustic, industrial, handmade, solid wood, and space-saving furniture designs along with our one-of-a-kind picture frame collections!

available at
amazon



Scan me

If you're satisfied with the product, please leave a review/feedback on our store, so that the others can benefit from our excellent products.

<https://gwhfactory.com/>