

# ASSEMBLY INSTRUCTIONS INSTRUCTIONS DE MONTAGE INSTRUCCIONES DE MONTAJE

## DRAWER NIGHTSTAND



**CAUTION:** PLEASE READ ALL INSTRUCTIONS BEFORE STARTING THE ASSEMBLY OF THIS PRODUCT. THESE PIECES ARE HEAVY. IN ORDER TO PREVENT PERSONAL INJURY AND ENSURE THAT THIS PRODUCT IS NOT DAMAGED DURING THE ASSEMBLY PROCESS, IT IS STRONGLY RECOMMENDED TO ENLIST THE ASSISTANCE OF ONE OR MORE PERSONS. IN CASE OF EXCESS STAIN, WIPE THE BOTTOM OF THE UNIT BEFORE PLACING ON ANY SURFACE.

**ATTENTION:** VEUILLEZ LIRE TOUTES LES INSTRUCTIONS AVANT DE COMMENCER L'ASSEMBLAGE DE CE PRODUIT. LES PIECES SONT LOURDES. POUR EVITER TOUTE BLESSURE ET POUR VOUS ASSURER QUE LE PRODUIT N'EST PAS ENDOMMAGE' PENDANT L'ASSEMBLAGE, NOUS VOUS RECOMMANDONS DE FAIRE APPEL A UNE OU PLUSIEURS AUTRES PERSONNES. EN CAS DE TACHE EXCESSIVE, ESSUYEZ LE FOND DE L'UNITE' AVANT LE PLACEMENT SUR N'IMPORTE QUELLE SURFACE.

**CUIDADO:** FAVOR DE LEER TODAS LAS INSTRUCCIONES ANTES DE ENSAMBLAR SU PRODUCTO, ESTAS. PIEZAS SON PESADAS. PARA PREVENIR HERIDAS PERSONALES Y ASEGURAR QUE SU PRODUCTO NO SEA DAN ADO MIENTRAS ES ENSAMBLADO. SE RECOMIENDA LA ASISTENCIA DE UNA O MAUS PERSONAS.

**WARNING:** PROTECTIVE GLIDE IS PLACED UNDER EACH LEG OF THE FURNITURE TO RESIST SCRATCHES ON FLOOR SURFACE. SOME FLOOR SURFACES CAN BE EXTRA SENSITIVE TO SCRATCHES AND MARKINGS, IF YOU ARE NOT SURE CONSULT WITH YOUR DEALER.  
AVERTISSEMENT. LES PIEDS DES MEUBLES SONT MUNIS DE PATINS DESTINES A PROTEGER LE PLANCHER. CERTAINS REVETEMENTS DE SOL PEUVENT ETRE TRES FRAGILES. EN CAS DE DOUTE. CONSULTER LE MARCHAND.

### LIST OF PARTS AND HARDWARE/ LISTE DES PIÈCES ET DU MATÉRIEL/ LISTA DE PIEZAS Y HARDWARE

NO#/ NOMBRE/ NÚMERO	DESCRIPTION/ DESCRIPTION/ DESCRIPCIÓN		QUANTITY/ QUANTITÉ/ CANTIDAD
1	DRAWER NIGHTSTAND		1 PC
2	TILT KIT BRACKET/ SUPPORT DE TROUSSE D'INCLINAISON/ KITDE SOPORTE DE INCLINACIÓN		1 SET

NOTE:  
ASSEMBLE UNIT ON A SOFT SURFACE.  
ASSEMBLEZ L'UNITÉ SUR UNE SURFACE MOLLE.  
ENSAMBLE LA UNIDAD EN UNA SUPERFICIE PLANA Y SUAVE.

DO NOT TIGHTEN BOLTS UNTIL **ALL PARTS AND HARDWARE** OF THE UNIT ARE ASSEMBLED.  
NE SERREZ PAS LES BOULONS JUSQU'À CE QUE L'UNITÉ SOIT COMPLÈTEMENT ASSEMBLÉE.  
NO APRIETE LOS TORNILLOS HASTA QUE LA UNIDAD ESTE COMPLETAMENTE ENSAMBLADA.



WARNING:  
ONLY USE THE HAND  
TOOLS PROVIDED

# ASSEMBLY INSTRUCTIONS INSTRUCTIONS DE MONTAGE INSTRUCCIONES DE MONTAJE

## DRAWER NIGHTSTAND

TIP KIT BRACKET LOCATION/  
EMPLACEMENT DU SUPPORT DU KIT  
DE POINTE/ UBICACIÓN DEL  
SOPORTE DEL KIT DE PUNTA

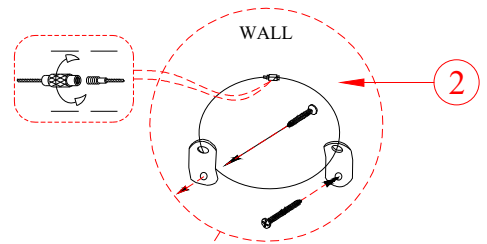

Step/ Étape/ Paso 2

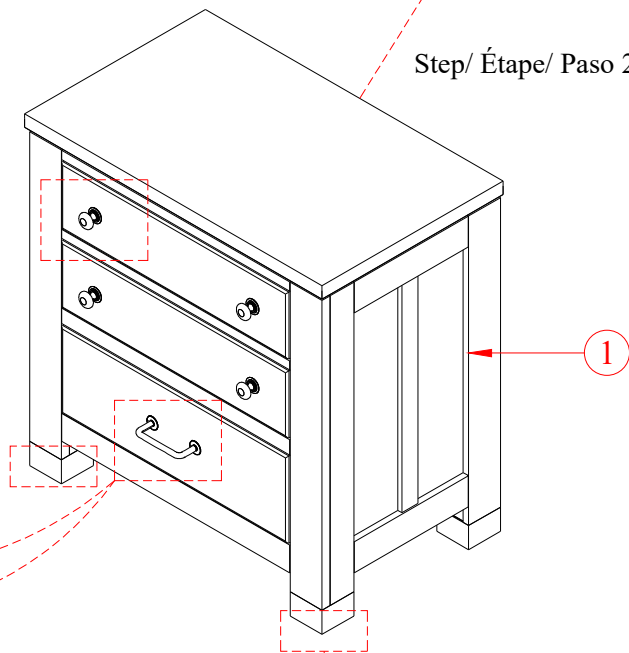

Not included

Step/ Étape/ Paso 1

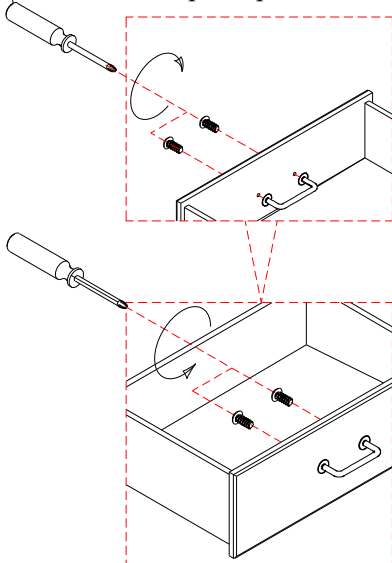

Adjust levelers

### NOTE:

Spirit level not included but necessary to level product on floor.

Niveau à bulle non inclus mais nécessaire pour niveler le produit au sol.

Nivel de burbuja no incluido pero necesario para nivelar el producto en el piso.



WARNING:  
ONLY USE THE HAND  
TOOLS PROVIDED

# ASSEMBLY INSTRUCTIONS INSTRUCTIONS DE MONTAGE INSTRUCCIONES DE MONTAJE

## BACHELOR CHEST WITH METAL DECORATION



**CAUTION:** PLEASE READ ALL INSTRUCTIONS BEFORE STARTING THE ASSEMBLY OF THIS PRODUCT. THESE PIECES ARE HEAVY. IN ORDER TO PREVENT PERSONAL INJURY AND ENSURE THAT THIS PRODUCT IS NOT DAMAGED DURING THE ASSEMBLY PROCESS, IT IS STRONGLY RECOMMENDED TO ENLIST THE ASSISTANCE OF ONE OR MORE PERSONS. IN CASE OF EXCESS STAIN, WIPE THE BOTTOM OF THE UNIT BEFORE PLACING ON ANY SURFACE.

**ATTENTION:** VEUILLEZ LIRE TOUTES LES INSTRUCTIONS AVANT DE COMMENCER L'ASSEMBLAGE DE CE PRODUIT. LES PIÈCES SONT LOURDES. POUR ÉVITER TOUTE BLESSURE ET POUR VOUS ASSURER QUE LE PRODUIT N'EST PAS ENDOMMAGÉ PENDANT L'ASSEMBLAGE, NOUS VOUS RECOMMANDONS DE FAIRE APPEL À UNE OU PLUSIEURS AUTRES PERSONNES. EN CAS DE TACHE EXCESSIVE, ESSUYEZ LE FOND DE L'UNITÉ AVANT LE PLACEMENT SUR N'IMPORTE QUELLE SURFACE.

**CUIDADO:** FAVOR DE LEER TODAS LAS INSTRUCCIONES ANTES DE ENSAMBLAR SU PRODUCTO, ESTAS PIEZAS SON PESADAS. PARA PREVENIR HERIDAS PERSONALES Y ASEGURAR QUE SU PRODUCTO NO SEA DAÑADO MIENTRAS ES ENSAMBLADO. SE RECOMIENDA LA ASISTENCIA DE UNA O MÁS PERSONAS.

**WARNING:** PROTECTIVE GLIDE IS PLACED UNDER EACH LEG OF THE FURNITURE TO RESIST SCRATCHES ON FLOOR SURFACE. SOME FLOOR SURFACES CAN BE EXTRA SENSITIVE TO SCRATCHES AND MARKINGS, IF YOU ARE NOT SURE CONSULT WITH YOUR DEALER.  
AVERTISSEMENT: LES PIEDS DES MEUBLES SONT MUNIS DE PATINS DESTINÉS À PROTÉGER LE PLANCHER. CERTAINS REVÊTEMENTS DE SOL PEUVENT ÊTRE TRÈS FRAGILES. EN CAS DE DOUTE, CONSULTEZ LE MARCHAND.

### LIST OF PARTS AND HARDWARE/ LISTE DES PIÈCES ET DU MATÉRIEL/ LISTA DE PIEZAS Y HARDWARE

NO#/ NOMBRE/ NÚMERO	DESCRIPTION/ DESCRIPTION/ DESCRIPCIÓN		QUANTITY/ QUANTITÉ/ CANTIDAD
1	BACHELOR CHEST		1 PC
2	TILT KIT BRACKET/ SUPPORT DE TROUSSE D'INCLINAISON/ KIT DE SOPORTE DE INCLINACIÓN		1 SET

NOTE:  
ASSEMBLE UNIT ON A SOFT SURFACE.  
ASSEMBLEZ L'UNITÉ SUR UNE SURFACE MOLLE.  
ENSAMBLE LA UNIDAD EN UNA SUPERFICIE PLANA Y SUAVE.

DO NOT TIGHTEN BOLTS UNTIL **ALL PARTS AND HARDWARE** OF THE UNIT ARE ASSEMBLED.  
NE SERREZ PAS LES BOULONS JUSQU'À CE QUE L'UNITÉ SOIT COMPLÈTEMENT ASSEMBLÉE.  
NO APRIETE LOS TORNILLOS HASTA QUE LA UNIDAD ESTE COMPLETAMENTE ENSAMBLADA.



WARNING:  
ONLY USE THE HAND  
TOOLS PROVIDED

# ASSEMBLY INSTRUCTIONS INSTRUCTIONS DE MONTAGE INSTRUCCIONES DE MONTAJE

## BACHELOR CHEST WITH METAL DECORATION

TIP KIT BRACKET LOCATION/  
EMPLACEMENT DU SUPPORT DU KIT  
DE POINTE/ UBICACIÓN DEL  
SOPORTE DEL KIT DE PUNTA

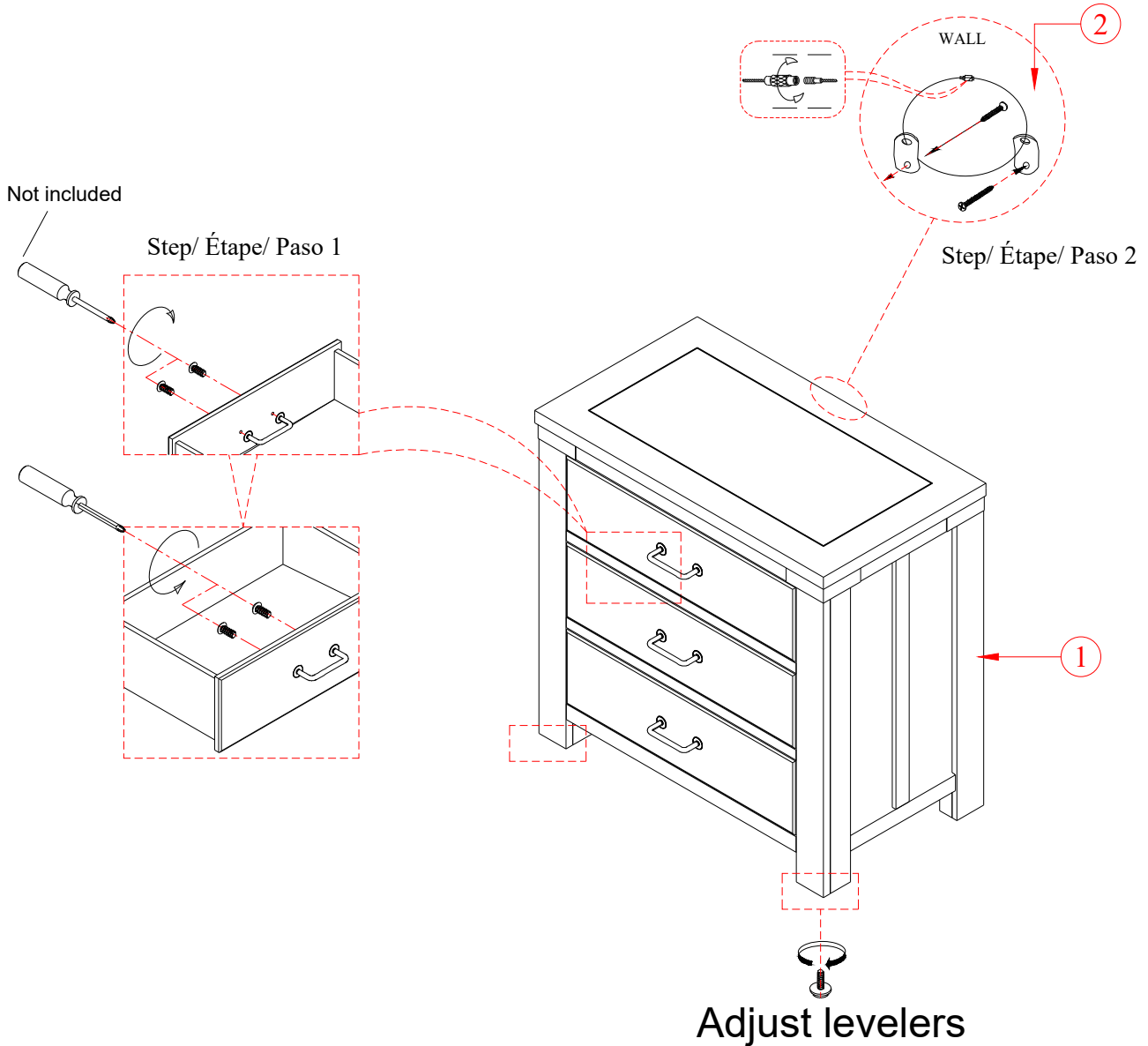

### NOTE:

Spirit level not included but necessary to level product on floor.

Niveau à bulle non inclus mais nécessaire pour niveler le produit au sol.

Nivel de burbuja no incluido pero necesario para nivelar el producto en el piso.



WARNING:  
ONLY USE THE HAND  
TOOLS PROVIDED

# ASSEMBLY INSTRUCTIONS INSTRUCTIONS DE MONTAGE INSTRUCCIONES DE MONTAJE

## DRAWER CHEST



**CAUTION:** PLEASE READ ALL INSTRUCTIONS BEFORE STARTING THE ASSEMBLY OF THIS PRODUCT. THESE PIECES ARE HEAVY. IN ORDER TO PREVENT PERSONAL INJURY AND ENSURE THAT THIS PRODUCT IS NOT DAMAGED DURING THE ASSEMBLY PROCESS, IT IS STRONGLY RECOMMENDED TO ENLIST THE ASSISTANCE OF ONE OR MORE PERSONS. IN CASE OF EXCESS STAIN, WIPE THE BOTTOM OF THE UNIT BEFORE PLACING ON ANY SURFACE.

**ATTENTION:** VEUILLEZ LIRE TOUTES LES INSTRUCTIONS AVANT DE COMMENCER L'ASSEMBLAGE DE CE PRODUIT. LES PIECES SONT LOURDES. POUR EVITER TOUTE BLESSURE ET POUR VOUS ASSURER QUE LE PRODUIT N'EST PAS ENDOMMAGE' PENDANT L'ASSEMBLAGE, NOUS VOUS RECOMMANDONS DE FAIRE APPEL A UNE OU PLUSIEURS AUTRES PERSONNES. EN CAS DE TACHE EXCESSIVE, ESSUYEZ LE FOND DE L'UNITE' AVANT LE PLACEMENT SUR N'IMPORTE QUELLE SURFACE.

**CUIDADO:** FAVOR DE LEER TODAS LAS INSTRUCCIONES ANTES DE ENSAMBLAR SU PRODUCTO, ESTAS. PIEZAS SON PESADAS. PARA PREVENIR HERIDAS PERSONALES Y ASEGURAR QUE SU PRODUCTO NO SEA DAN ADO MIENTRAS ES ENSAMBLADO. SE RECOMIENDA LA ASISTENCIA DE UNA O MAUS PERSONAS.

**WARNING:** PROTECTIVE GLIDE IS PLACED UNDER EACH LEG OF THE FURNITURE TO RESIST SCRATCHES ON FLOOR SURFACE. SOME FLOOR SURFACES CAN BE EXTRA SENSITIVE TO SCRATCHES AND MARKINGS, IF YOU ARE NOT SURE CONSULT WITH YOUR DEALER.  
AVERTISSEMENT. LES PIEDS DES MEUBLES SONT MUNIS DE PATINS DESTINES A PROTEGER LE PLANCHER. CERTAINS REVETEMENTS DE SOL PEUVENT ETRE TRES FRAGILES. EN CAS DE DOUTE. CONSULTER LE MARCHAND.

### LIST OF PARTS AND HARDWARE/ LISTE DES PIÈCES ET DU MATÉRIEL/ LISTA DE PIEZAS Y HARDWARE

NO#/ NOMBRE/ NÚMERO	DESCRIPTION/ DESCRIPTION/ DESCRIPCIÓN		QUANTITY/ QUANTITÉ/ CANTIDAD
1	DRAWER CHEST		1 PC
2	TILT KIT BRACKET/ SUPPORT DE TROUSSE D'INCLINAISON/ KITDE SOPORTE DE INCLINACIÓN		1 SET

NOTE:  
ASSEMBLE UNIT ON A SOFT SURFACE.  
ASSEMBLEZ L'UNITÉ SUR UNE SURFACE MOLLE.  
ENSAMBLE LA UNIDAD EN UNA SUPERFICIE PLANA Y SUAVE.

DO NOT TIGHTEN BOLTS UNTIL **ALL PARTS AND HARDWARE OF** THE UNIT ARE ASSEMBLED.  
NE SERREZ PAS LES BOULONS JUSQU'À CE QUE L'UNITÉ SOIT COMPLÈTEMENT ASSEMBLÉE.  
NO APRIETE LOS TORNILLOS HASTA QUE LA UNIDAD ESTE COMPLETAMENTE ENSAMBLADA.



WARNING:  
ONLY USE THE HAND  
TOOLS PROVIDED

# ASSEMBLY INSTRUCTIONS INSTRUCTIONS DE MONTAGE INSTRUCCIONES DE MONTAJE

## DRAWER CHEST

TIP KIT BRACKET LOCATION/  
EMPLACEMENT DU SUPPORT DU KIT  
DE POINTE/ UBICACIÓN DEL  
SOPORTE DEL KIT DE PUNTA

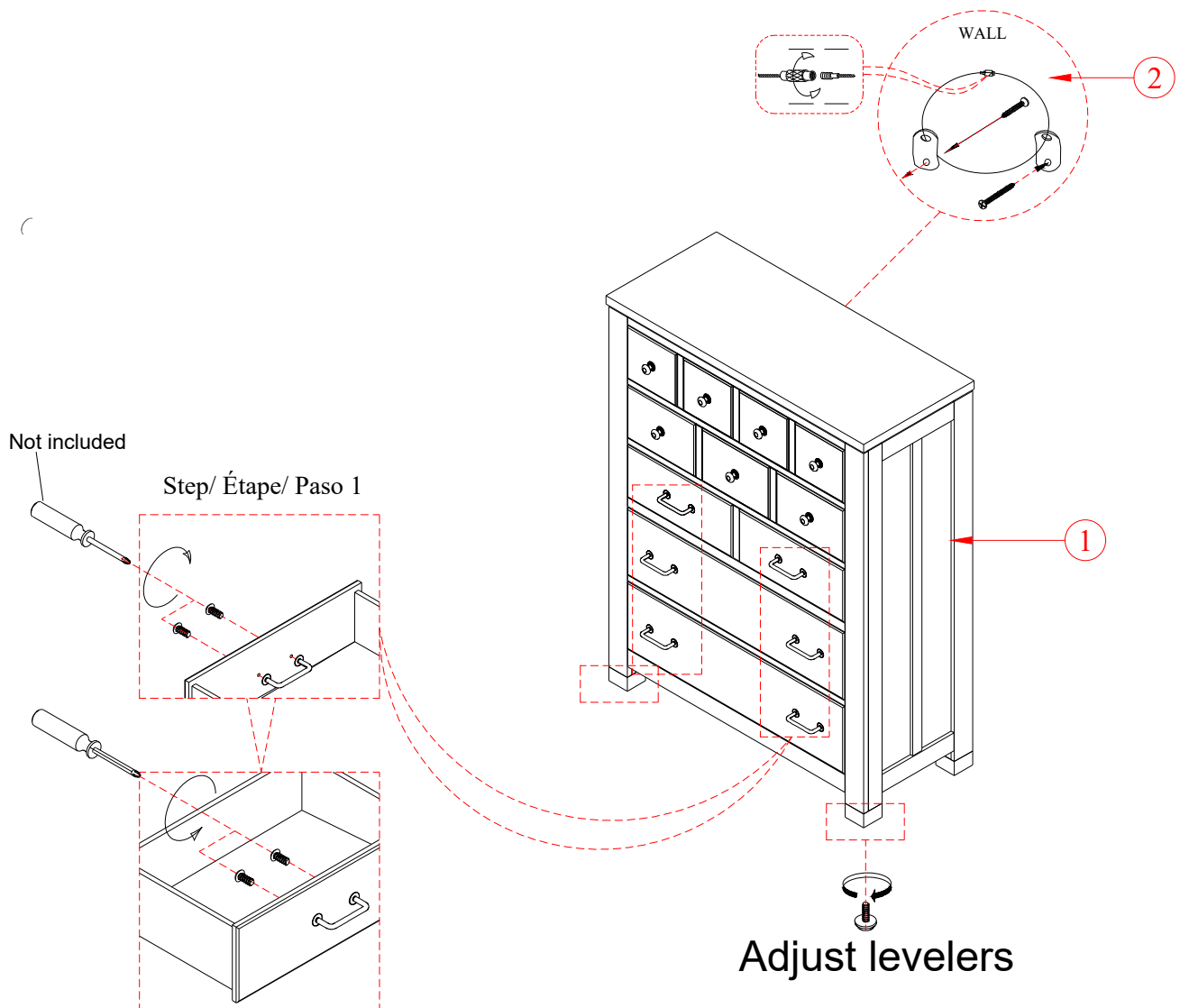

### NOTE:

Spirit level not included but necessary to level product on floor.

Niveau à bulle non inclus mais nécessaire pour niveler le produit au sol.

Nivel de burbuja no incluido pero necesario para nivelar el producto en el piso.



WARNING:  
ONLY USE THE HAND  
TOOLS PROVIDED

# ASSEMBLY INSTRUCTIONS INSTRUCTIONS DE MONTAGE INSTRUCCIONES DE MONTAJE

## DOOR CHEST



**CAUTION:** PLEASE READ ALL INSTRUCTIONS BEFORE STARTING THE ASSEMBLY OF THIS PRODUCT. THESE PIECES ARE HEAVY. IN ORDER TO PREVENT PERSONAL INJURY AND ENSURE THAT THIS PRODUCT IS NOT DAMAGED DURING THE ASSEMBLY PROCESS, IT IS STRONGLY RECOMMENDED TO ENLIST THE ASSISTANCE OF ONE OR MORE PERSONS. IN CASE OF EXCESS STAIN, WIPE THE BOTTOM OF THE UNIT BEFORE PLACING ON ANY SURFACE.

**ATTENTION:** VEUILLEZ LIRE TOUTES LES INSTRUCTIONS AVANT DE COMMENCER L'ASSEMBLAGE DE CE PRODUIT. LES PIECES SONT LOURDES. POUR EVITER TOUTE BLESSURE ET POUR VOUS ASSURER QUE LE PRODUIT N'EST PAS ENDOMMAGE' PENDANT L'ASSEMBLAGE, NOUS VOUS RECOMMANDONS DE FAIRE APPEL A UNE OU PLUSIEURS AUTRES PERSONNES. EN CAS DE TACHE EXCESSIVE, ESSUYEZ LE FOND DE L'UNITE' AVANT LE PLACEMENT SUR N'IMPORTE QUELLE SURFACE.



**CUIDADO:** FAVOR DE LEER TODAS LAS INSTRUCCIONES ANTES DE ENSAMBLAR SU PRODUCTO, ESTAS. PIEZAS SON PESADAS. PARA PREVENIR HERIDAS PERSONALES Y ASEGURAR QUE SU PRODUCTO NO SEA DAN ADO MIENTRAS ES ENSAMBLADO. SE RECOMIENDA LA ASISTENCIA DE UNA O MAUS PERSONAS.

**WARNING:** PROTECTIVE GLIDE IS PLACED UNDER EACH LEG OF THE FURNITURE TO RESIST SCRATCHES ON FLOOR SURFACE. SOME FLOOR SURFACES CAN BE EXTRA SENSITIVE TO SCRATCHES AND MARKINGS, IF YOU ARE NOT SURE CONSULT WITH YOUR DEALER.  
AVERTISSEMENT. LES PIEDS DES MEUBLES SONT MUNIS DE PATINS DESTINES A PROTEGER LE PLANCHER. CERTAINS REVETEMENTS DE SOL PEUVENT ETRE TRES FRAGILES. EN CAS DE DOUTE. CONSULTER LE MARCHAND.

### LIST OF PARTS AND HARDWARE/ LISTE DES PIÈCES ET DU MATÉRIEL/ LISTA DE PIEZAS Y HARDWARE

NO#/ NOMBRE/ NÚMERO	DESCRIPTION/ DESCRIPTION/ DESCRIPCIÓN		QUANTITY/ QUANTITÉ/ CANTIDAD
A	SHELF CLIP/CLIP D'ÉTAGÈRE/ CLIP DE ESTANTE		8 PCS
B	SCREW/ VIS/ TORNILLO		8 PCS

### LIST OF PARTS AND HARDWARE/ LISTE DES PIÈCES ET DU MATÉRIEL/ LISTA DE PIEZAS Y HARDWARE

NO#/ NOMBRE/ NÚMERO	DESCRIPTION/ DESCRIPTION/ DESCRIPCIÓN		QUANTITY/ QUANTITÉ/ CANTIDAD
1	DOOR CHEST		1 PC
2	SHELF PANEL/ PANNEAU D'ÉTAGÈRE / PANEL DE ESTANTES		2 PCS
3	TILT KIT BRACKET/ SUPPORT DE TROUSSE D'INCLINAISON/ KITDE SOPORTE DE INCLINACIÓN		1 SET

NOTE:  
ASSEMBLE UNIT ON A SOFT SURFACE.  
ASSEMBLEZ L'UNITÉ SUR UNE SURFACE MOLLE.  
ENSAMBLE LA UNIDAD EN UNA SUPERFICIE PLANA Y SUAVE.

DO NOT TIGHTEN BOLTS UNTIL **ALL PARTS AND HARDWARE OF** THE UNIT ARE ASSEMBLED.  
NE SERREZ PAS LES BOULONS JUSQU'À CE QUE L'UNITÉ SOIT COMPLÈTEMENT ASSEMBLÉE.  
NO APRIETE LOS TORNILLOS HASTA QUE LA UNIDAD ESTE COMPLETAMENTE ENSAMBLADA.



WARNING:  
ONLY USE THE HAND  
TOOLS PROVIDED

# ASSEMBLY INSTRUCTIONS INSTRUCTIONS DE MONTAGE INSTRUCCIONES DE MONTAJE

## DOOR CHEST

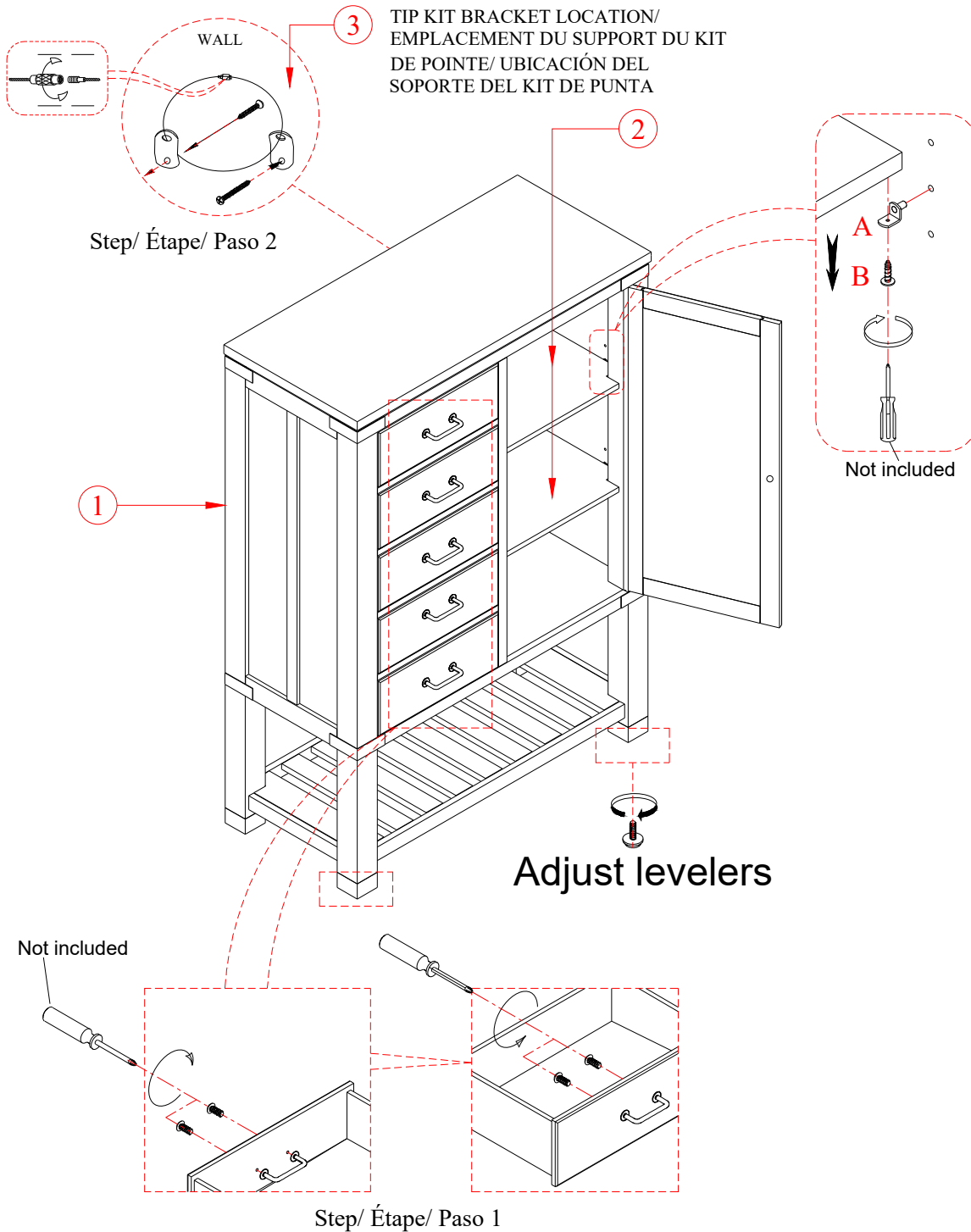

### NOTE:

Spirit level not included but necessary to level product on floor.

Niveau à bulle non inclus mais nécessaire pour niveler le produit au sol.

Nivel de burbuja no incluido pero necesario para nivelar el producto en el piso.



WARNING:  
ONLY USE THE HAND  
TOOLS PROVIDED

# ASSEMBLY INSTRUCTIONS INSTRUCTIONS DE MONTAGE INSTRUCCIONES DE MONTAJE

## DOOR DRESSER



**CAUTION:** PLEASE READ ALL INSTRUCTIONS BEFORE STARTING THE ASSEMBLY OF THIS PRODUCT. THESE PIECES ARE HEAVY. IN ORDER TO PREVENT PERSONAL INJURY AND ENSURE THAT THIS PRODUCT IS NOT DAMAGED DURING THE ASSEMBLY PROCESS, IT IS STRONGLY RECOMMENDED TO ENLIST THE ASSISTANCE OF ONE OR MORE PERSONS. IN CASE OF EXCESS STAIN, WIPE THE BOTTOM OF THE UNIT BEFORE PLACING ON ANY SURFACE.

**ATTENTION:** VEUILLEZ LIRE TOUTES LES INSTRUCTIONS AVANT DE COMMENCER L'ASSEMBLAGE DE CE PRODUIT. LES PIÉCES SONT LOURDES. POUR ÉVITER TOUTE BLESSURE ET POUR VOUS ASSURER QUE LE PRODUIT N'EST PAS ENDOMMAGÉ PENDANT L'ASSEMBLAGE, NOUS VOUS RECOMMANDONS DE FAIRE APPEL À UNE OU PLUSIEURS AUTRES PERSONNES. EN CAS DE TACHE EXCESSIVE, ESSUYEZ LE FOND DE L'UNITÉ AVANT LE PLACEMENT SUR N'IMPORTE QUELLE SURFACE.



**CUIDADO:** FAVOR DE LEER TODAS LAS INSTRUCCIONES ANTES DE ENSAMBLAR SU PRODUCTO, ESTAS PIEZAS SON PESADAS. PARA PREVENIR HERIDAS PERSONALES Y ASEGURAR QUE SU PRODUCTO NO SEA DAÑADO MIENTRAS ES ENSAMBLADO. SE RECOMIENDA LA ASISTENCIA DE UNA O MÁS PERSONAS.

**WARNING:** PROTECTIVE GLIDE IS PLACED UNDER EACH LEG OF THE FURNITURE TO RESIST SCRATCHES ON FLOOR SURFACE. SOME FLOOR SURFACES CAN BE EXTRA SENSITIVE TO SCRATCHES AND MARKINGS, IF YOU ARE NOT SURE CONSULT WITH YOUR DEALER.  
AVERTISSEMENT: LES PIEDS DES MEUBLES SONT MUNIS DE PATINS DESTINÉS À PROTÉGER LE PLANCHER. CERTAINS REVÊTEMENTS DE SOL PEUVENT ÊTRE TRÈS FRAGILES. EN CAS DE DOUTE, CONSULTEZ LE MARCHAND.

### LIST OF PARTS AND HARDWARE/ LISTE DES PIÈCES ET DU MATÉRIEL/ LISTA DE PIEZAS Y HARDWARE

NO#/ NOMBRE/ NÚMERO	DESCRIPTION/ DESCRIPTION/ DESCRIPCIÓN		QUANTITY/ QUANTITÉ/ CANTIDAD
A	SHELF CLIP/CLIP D'ÉTAGÈRE/ CLIP DE ESTANTE		8 PCS
B	SCREW/ VIS/ TORNILLO	M4 x 1/2" LENGTH 	8 PCS

### LIST OF PARTS AND HARDWARE/ LISTE DES PIÈCES ET DU MATÉRIEL/ LISTA DE PIEZAS Y HARDWARE

NO#/ NOMBRE/ NÚMERO	DESCRIPTION/ DESCRIPTION/ DESCRIPCIÓN		QUANTITY/ QUANTITÉ/ CANTIDAD
1	DOOR DRESSER		1 PC
2	SHELF PANEL/ PANNEAU D'ÉTAGÈRE / PANEL DE ESTANTES		2 PCS
3	TILT KIT BRACKET/ SUPPORT DE TROUSSE D'INCLINAISON/ KIT DE SOPORTE DE INCLINACIÓN		1 SET

NOTE:  
ASSEMBLE UNIT ON A SOFT SURFACE.  
ASSEMBLEZ L'UNITÉ SUR UNE SURFACE MOLLE.  
ENSAMBLE LA UNIDAD EN UNA SUPERFICIE PLANA Y SUAVE.

DO NOT TIGHTEN BOLTS UNTIL **ALL PARTS AND HARDWARE OF THE UNIT** ARE ASSEMBLED.  
NE SERREZ PAS LES BOULONS JUSQU'À CE QUE L'UNITÉ SOIT COMPLÈTEMENT ASSEMBLÉE.  
NO APRIETE LOS TORNILLOS HASTA QUE LA UNIDAD ESTE COMPLETAMENTE ENSAMBLADA.



WARNING:  
ONLY USE THE HAND  
TOOLS PROVIDED

# ASSEMBLY INSTRUCTIONS INSTRUCTIONS DE MONTAGE INSTRUCCIONES DE MONTAJE

## DOOR DRESSER

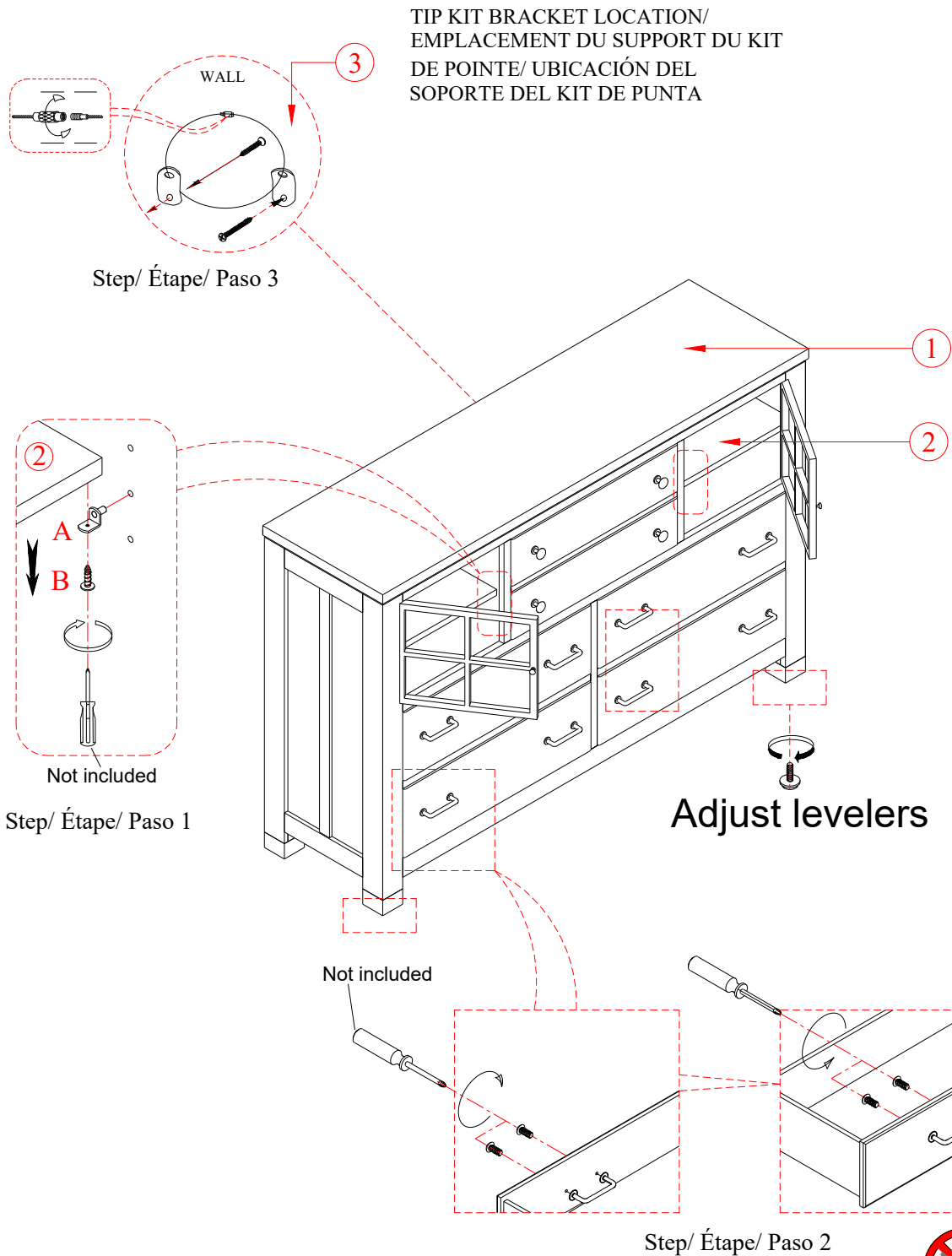

**NOTE:**

Spirit level not included but necessary to level product on floor.

Niveau à bulle non inclus mais nécessaire pour niveler le produit au sol.

Nivel de burbuja no incluido pero necesario para nivelar el producto en el piso.



**WARNING:  
ONLY USE THE HAND  
TOOLS PROVIDED**

# ASSEMBLY INSTRUCTIONS INSTRUCTIONS DE MONTAGE INSTRUCCIONES DE MONTAJE

## DRAWER DRESSER



**CAUTION:** PLEASE READ ALL INSTRUCTIONS BEFORE STARTING THE ASSEMBLY OF THIS PRODUCT. THESE PIECES ARE HEAVY. IN ORDER TO PREVENT PERSONAL INJURY AND ENSURE THAT THIS PRODUCT IS NOT DAMAGED DURING THE ASSEMBLY PROCESS, IT IS STRONGLY RECOMMENDED TO ENLIST THE ASSISTANCE OF ONE OR MORE PERSONS. IN CASE OF EXCESS STAIN, WIPE THE BOTTOM OF THE UNIT BEFORE PLACING ON ANY SURFACE.

**ATTENTION:** VEUILLEZ LIRE TOUTES LES INSTRUCTIONS AVANT DE COMMENCER L'ASSEMBLAGE DE CE PRODUIT. LES PIECES SONT LOURDES. POUR EVITER TOUTE BLESSURE ET POUR VOUS ASSURER QUE LE PRODUIT N'EST PAS ENDOMMAGE' PENDANT L'ASSEMBLAGE, NOUS VOUS RECOMMANDONS DE FAIRE APPEL A UNE OU PLUSIEURS AUTRES PERSONNES. EN CAS DE TACHE EXCESSIVE, ESSUYEZ LE FOND DE L'UNITE' AVANT LE PLACEMENT SUR N'IMPORTE QUELLE SURFACE.

**CUIDADO:** FAVOR DE LEER TODAS LAS INSTRUCCIONES ANTES DE ENSAMBLAR SU PRODUCTO, ESTAS PIEZAS SON PESADAS. PARA PREVENIR HERIDAS PERSONALES Y ASEGURAR QUE SU PRODUCTO NO SEA DAN ADO MIENTRAS ES ENSAMBLADO. SE RECOMIENDA LA ASISTENCIA DE UNA O MAUS PERSONAS.

**WARNING:** PROTECTIVE GLIDE IS PLACED UNDER EACH LEG OF THE FURNITURE TO RESIST SCRATCHES ON FLOOR SURFACE. SOME FLOOR SURFACES CAN BE EXTRA SENSITIVE TO SCRATCHES AND MARKINGS, IF YOU ARE NOT SURE CONSULT WITH YOUR DEALER. AVERTISSEMENT. LES PIEDS DES MEUBLES SONT MUNIS DE PATINS DESTINES A PROTEGER LE PLANCHER. CERTAINS REVETEMENTS DE SOL PEUVENT ETRE TRES FRAGILES. EN CAS DE DOUTE. CONSULTER LE MARCHAND.

### LIST OF PARTS AND HARDWARE/ LISTE DES PIÈCES ET DU MATÉRIEL/ LISTA DE PIEZAS Y HARDWARE

NO#/ NOMBRE/ NÚMERO	DESCRIPTION/ DESCRIPTION/ DESCRIPCIÓN		QUANTITY/ QUANTITÉ/ CANTIDAD
1	DRAWER DRESSER		1 PC
2	TILT KIT BRACKET/ SUPPORT DE TROUSSE D'INCLINAISON/ KITDE SOPORTE DE INCLINACIÓN		1 PC.

NOTE:  
ASSEMBLE UNIT ON A SOFT SURFACE.  
ASSEMBLEZ L'UNITÉ SUR UNE SURFACE MOLLE.  
ENSAMBLE LA UNIDAD EN UNA SUPERFICIE PLANA Y SUAVE.

DO NOT TIGHTEN BOLTS UNTIL **ALL PARTS AND HARDWARE OF** THE UNIT ARE ASSEMBLED.  
NE SERREZ PAS LES BOULONS JUSQU'À CE QUE L'UNITÉ SOIT COMPLÈTEMENT ASSEMBLÉE.  
NO APRIETE LOS TORNILLOS HASTA QUE LA UNIDAD ESTE COMPLETAMENTE ENSAMBLADA.

# ASSEMBLY INSTRUCTIONS INSTRUCTIONS DE MONTAGE INSTRUCCIONES DE MONTAJE

## DRAWER DRESSER

TIP KIT BRACKET LOCATION/  
EMPLACEMENT DU SUPPORT DU KIT  
DE POINTE/ UBICACIÓN DEL  
SOPORTE DEL KIT DE PUNTA

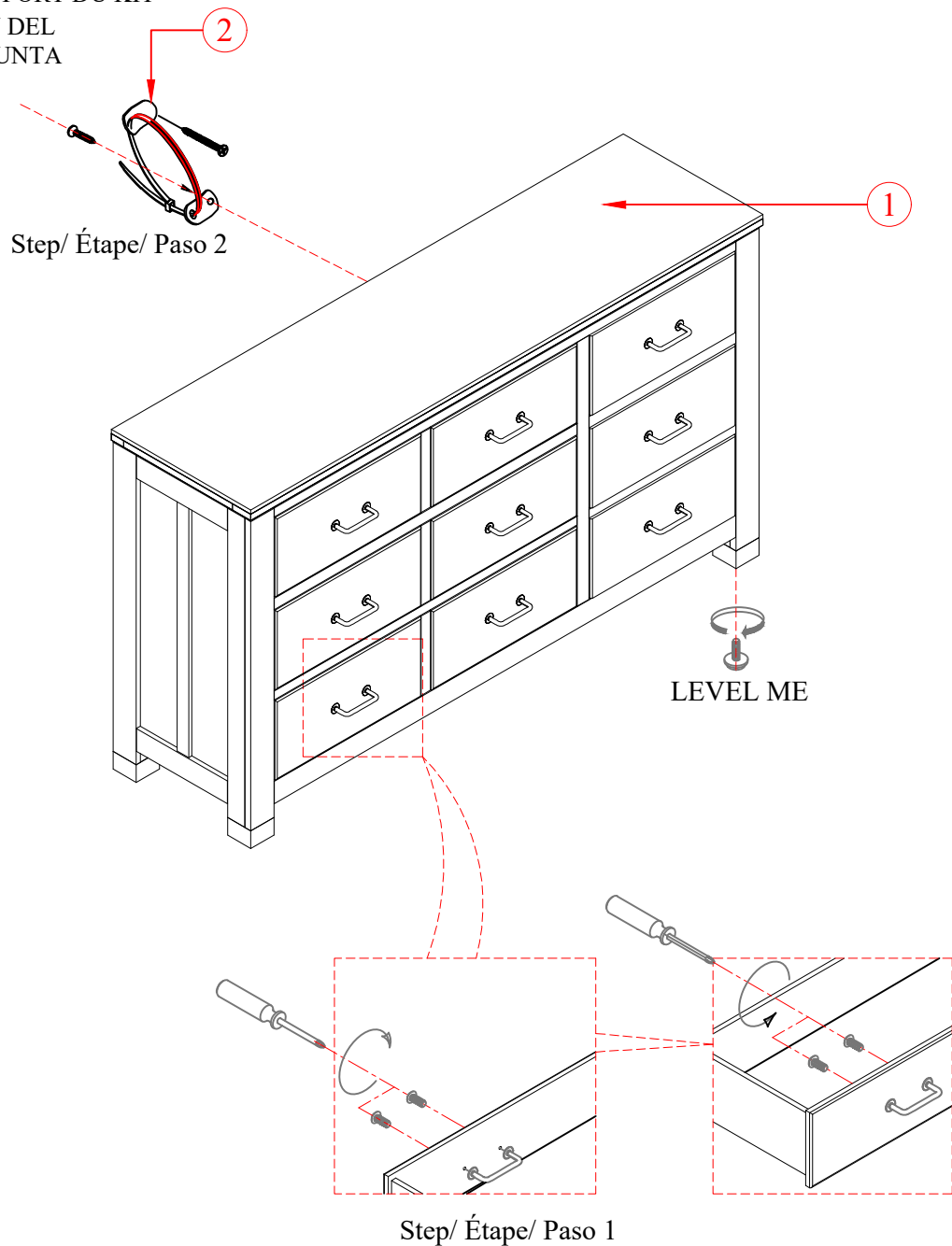

NOTE:  
SPIRIT LEVELER NOT INCLUDED BUT NEEDED TO EVEN THE FLOOR.  
SPIRIT LEVELER NON INCLUS MAIS NÉCESSAIRE MÊME LE SOL.  
NIVELADOR DE ESPÍRITU NO INCLUIDO PERO ES NECESARIO PARA INCLUSO EL PISO.

# ASSEMBLY INSTRUCTIONS INSTRUCTIONS DE MONTAGE INSTRUCCIONES DE MONTAJE

## DRAWER DRESSER LANDSCAPE MIRROR





**CAUTION:** PLEASE READ ALL INSTRUCTIONS BEFORE STARTING THE ASSEMBLY OF THIS PRODUCT. THESE PIECES ARE HEAVY. IN ORDER TO PREVENT PERSONAL INJURY AND ENSURE THAT THIS PRODUCT IS NOT DAMAGED DURING THE ASSEMBLY PROCESS, IT IS STRONGLY RECOMMENDED TO ENLIST THE ASSISTANCE OF ONE OR MORE PERSONS. IN CASE OF EXCESS STAIN, WIPE THE BOTTOM OF THE UNIT BEFORE PLACING ON ANY SURFACE.

**ATTENTION:** VEUILLEZ LIRE TOUTES LES INSTRUCTIONS AVANT DE COMMENCER L'ASSEMBLAGE DE CE PRODUIT. LES PIÉCES SONT LOURDES. POUR ÉVITER TOUTE BLESSURE ET POUR VOUS ASSURER QUE LE PRODUIT N'EST PAS ENDOMMAGÉ PENDANT L'ASSEMBLAGE, NOUS VOUS RECOMMANDONS DE FAIRE APPEL À UNE OU PLUSIEURS AUTRES PERSONNES. EN CAS DE TACHE EXCESSIVE, ESSUYEZ LE FOND DE L'UNITÉ AVANT LE PLACEMENT SUR N'IMPORTE QUELLE SURFACE.



**CUIDADO:** FAVOR DE LEER TODAS LAS INSTRUCCIONES ANTES DE ENSAMBLAR SU PRODUCTO, ESTAS PIEZAS SON PESADAS. PARA PREVENIR HERIDAS PERSONALES Y ASEGURAR QUE SU PRODUCTO NO SEA DAÑADO MIENTRAS ES ENSAMBLADO. SE RECOMIENDA LA ASISTENCIA DE UNA O MÁS PERSONAS.

**WARNING:** PROTECTIVE GLIDE IS PLACED UNDER EACH LEG OF THE FURNITURE TO RESIST SCRATCHES ON FLOOR SURFACE. SOME FLOOR SURFACES CAN BE EXTRA SENSITIVE TO SCRATCHES AND MARKINGS, IF YOU ARE NOT SURE CONSULT WITH YOUR DEALER. AVERTISSEMENT. LES PIEDS DES MEUBLES SONT MUNIS DE PATINS DESTINÉS À PROTÉGER LE PLANCHER. CERTAINS REVÊTEMENTS DE SOL PEUVENT ÊTRE TRÈS FRAGILES. EN CAS DE DOUTE, CONSULTEZ LE MARCHAND.

### LIST OF PARTS AND HARDWARE/ LISTE DES PIÈCES ET DU MATÉRIEL/ LISTA DE PIEZAS Y HARDWARE

NO#/ NOMBRE/ NÚMERO	DESCRIPTION/ DESCRIPTION/ DESCRIPCIÓN		QUANTITY/ QUANTITÉ/ CANTIDAD
A	FLAT WASHER/ RONDELLE PLATE/ ARANDELA PLANA $\frac{1}{4}$ " DIAMETER x $\frac{3}{4}$ " x $\frac{1}{16}$ "		8 PCS
B	LOCK WASHER/ RONDELLE DE BLOCAGE/ ARANDELA DE BLOQUEO $\frac{1}{4}$ " DIAMETER x $\frac{1}{2}$ " x $\frac{1}{16}$ "		8 PCS
C	BOLT/ BOULON/ TORNILLO DE TUERCA $\frac{1}{4}$ " DIAMETER x $1\frac{3}{8}$ " LENGTH		8 PCS
D	ALLEN KEY/ ALLEN/ LLAVE ALLEN 1/2"		1 PC

### LIST OF PARTS AND HARDWARE/ LISTE DES PIÈCES ET DU MATÉRIEL/ LISTA DE PIEZAS Y HARDWARE

NO#/ NOMBRE/ NÚMERO	DESCRIPTION/ DESCRIPTION/ DESCRIPCIÓN		QUANTITY/ QUANTITÉ/ CANTIDAD
1	MIRROR/ MIROIR/ ESPEJO		1 PC
2	DRESSER/ LA COMMODOE/ VESTIDOR		1 PC
3	MIRROR SUPPORT RAIL/ RAIL DE SOUTIEN DU MIROIR/ SUPORTE PARA ESPEJO		2 PCS

NOTE:  
ASSEMBLE UNIT ON A SOFT SURFACE.  
ASSEMBLEZ L'UNITÉ SUR UNE SURFACE MOLLE.  
ENSAMBLE LA UNIDAD EN UNA SUPERFICIE PLANA Y SUAVE.

DO NOT TIGHTEN BOLTS UNTIL ALL PARTS AND HARDWARE OF THE UNIT ARE ASSEMBLED.  
NE SERREZ PAS LES BOULONS JUSQU'À CE QUE L'UNITÉ SOIT COMPLÈTEMENT ASSEMBLÉE.  
NO APRIETE LOS TORNILLOS HASTA QUE LA UNIDAD ESTE COMPLETAMENTE ENSAMBLADA.

# ASSEMBLY INSTRUCTIONS INSTRUCTIONS DE MONTAGE INSTRUCCIONES DE MONTAJE

## DRAWER DRESSER LANDSCAPE MIRROR

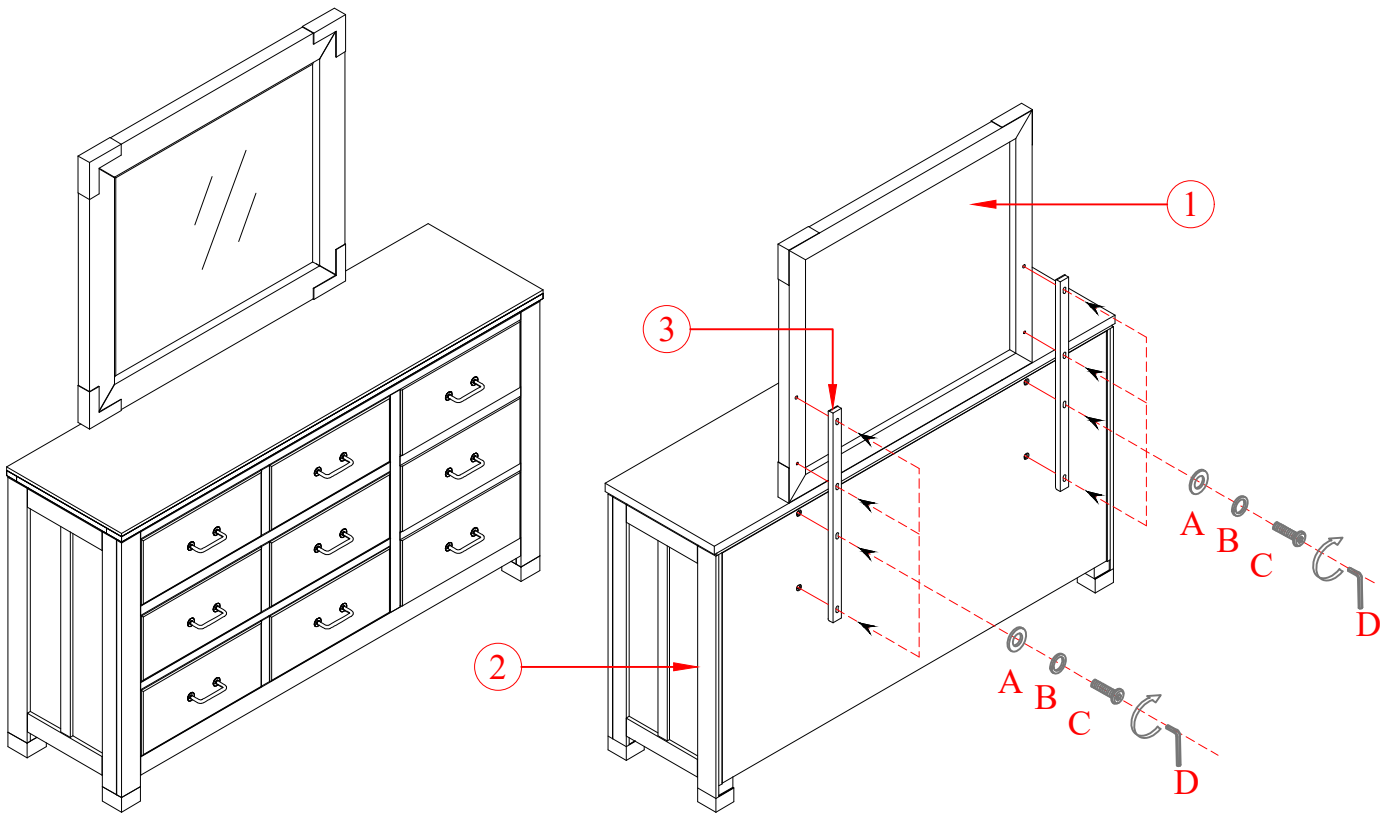

NOTE:  
SPIRIT LEVELER NOT INCLUDED BUT NEEDED TO EVEN THE FLOOR.  
SPIRIT LEVELER NON INCLUS MAIS NÉCESSAIRE MÊME LE SOL.  
NIVELADOR DE ESPÍRITU NO INCLUIDO PERO ES NECESARIO PARA INCLUSO EL PISO.

# ASSEMBLY INSTRUCTIONS INSTRUCTIONS DE MONTAGE INSTRUCCIONES DE MONTAJE

## QUEEN PANEL BED

**CAUTION:** PLEASE READ ALL INSTRUCTIONS BEFORE STARTING THE ASSEMBLY OF THIS PRODUCT. THESE PIECES ARE HEAVY. IN ORDER TO PREVENT PERSONAL INJURY AND ENSURE THAT THIS PRODUCT IS NOT DAMAGED DURING THE ASSEMBLY PROCESS, IT IS STRONGLY RECOMMENDED TO ENLIST THE ASSISTANCE OF ONE OR MORE PERSONS. IN CASE OF EXCESS STAIN, WIPE THE BOTTOM OF THE UNIT BEFORE PLACING ON ANY SURFACE.

**ATTENTION:** VEUILLEZ LIRE TOUTES LES INSTRUCTIONS AVANT DE COMMENCER L'ASSEMBLAGE DE CE PRODUIT. LES PIECES SONT LOURDES. POUR EVITER TOUTE BLESSURE ET POUR VOUS ASSURER QUE LE PRODUIT N'EST PAS ENDOMMAGE' PENDANT L'ASSEMBLAGE, NOUS VOUS RECOMMANDONS DE FAIRE APPEL A UNE OU PLUSIEURS AUTRES PERSONNES. EN CAS DE TACHE EXCESSIVE, ESSUYEZ LE FOND DE L'UNITE' AVANT LE PLACEMENT SUR N'IMPORTE QUELLE SURFACE.

**CUIDADO:** FAVOR DE LEER TODAS LAS INSTRUCCIONES ANTES DE ENSAMBLAR SU PRODUCTO, ESTAS PIEZAS SON PESADAS. PARA PREVENIR HERIDAS PERSONALES Y ASEGURAR QUE SU PRODUCTO NO SEA DANADO MIENTRAS ES ENSAMBLADO. SE RECOMIENDA LA ASISTENCIA DE UNA O MAS PERSONAS.

**WARNING:** PROTECTIVE GLIDE IS PLACED UNDER EACH LEG OF THE FURNITURE TO RESIST SCRATCHES ON FLOOR SURFACE. SOME FLOOR SURFACES CAN BE EXTRA SENSITIVE TO SCRATCHES AND MARKINGS, IF YOU ARE NOT SURE CONSULT WITH YOUR DEALER. AVERTISSEMENT. LES PIEDS DES MEUBLES SONT MUNIS DE PATINS DESTINES A PROTEGER LE PLANCHER. CERTAINS REVETEMENTS DE SOL PEUVENT ETRE TRES FRAGILES. EN CAS DE DOUTE. CONSULTER LE MARCHAND.

**NOTE:**

MUST USE 3 Watts, 12 Volt DC Bulb with E26/E27 SOCKET.  
DOIT UTILISER UNE AMPOULE DE 3 WATTS, 12 VOLTS DC AVEC PRISE E26 / E27.  
DEBE USAR 3 WATTS, BOMBILLA DE 12 VOLTIOS DC CON ENCHUFE E26 / E27.

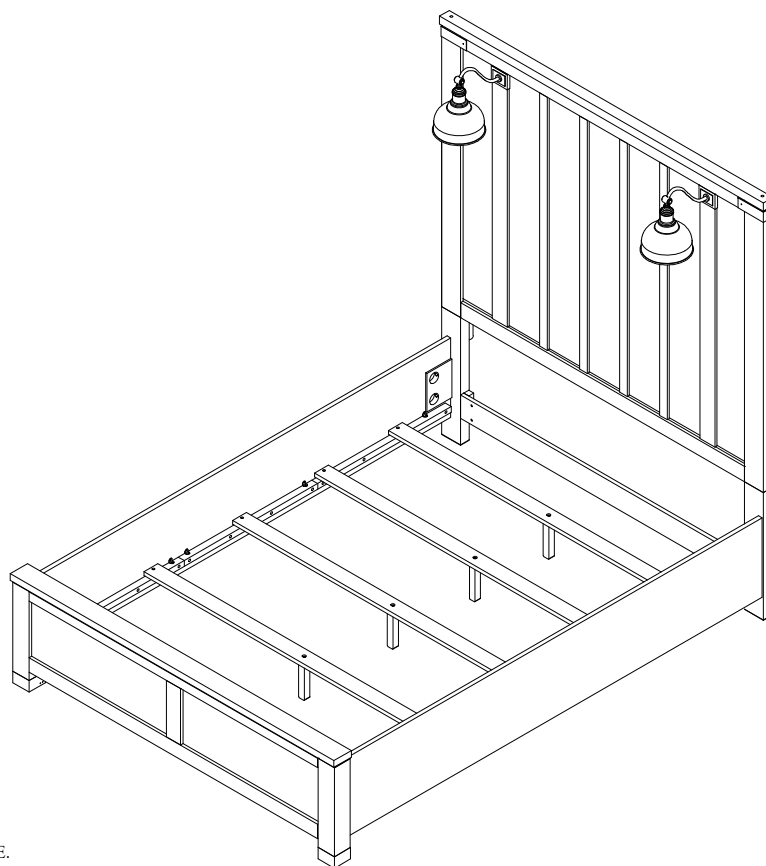









**NOTE:**  
ASSEMBLE UNIT ON A SOFT SURFACE.  
ASSEMBLEZ L'UNITE' SUR UNE SURFACE MOLLE.  
ENSAMBLE LA UNIDAD EN UNA SUPERFICIE PLANA Y SUAVE.

DO NOT TIGHTEN BOLTS UNTIL **ALL PARTS AND HARDWARE OF THE UNIT ARE ASSEMBLED.**  
NE SERREZ PAS LES BOULONS JUSQU'À CE QUE L'UNITE' SOIT COMPLÈTEMENT ASSEMBLÉE.  
NO APRIETE LOS TORNILLOS HASTA QUE LA UNIDAD ESTE COMPLETAMENTE ENSAMBLADA.













# ASSEMBLY INSTRUCTIONS INSTRUCTIONS DE MONTAGE INSTRUCCIONES DE MONTAJE

## QUEEN PANEL BED

### LIST OF PARTS AND HARDWARE/ LISTE DES PIÈCES ET DU MATÉRIEL/ LISTA DE PIEZAS Y HARDWARE

NO#/ NOMBRE/ NÚMERO	DESCRIPTION/ DESCRIPTION/ DESCRIPCIÓN		QUANTITY/ QUANTITÉ/ CANTIDAD
A	BOLT/ BOULON/ TORNILLO $\frac{5}{16}$ " DIAMETER x $4\frac{1}{2}$ " LENGTH		8 PCS
B	LOCK WASHER "C"/ RONDELLE DE BLOCAGE "C"/ ARANDELA DE BLOQUEO "C" $\frac{5}{16}$ " DIAMETER		8 PCS
C	NUT/ ÉCROU/ NUEZ $\frac{5}{16}$ " DIAMETER		8 PCS
D	WRENCH/ CLÉ/ LLAVE INGLESA $\frac{1}{2}$ "		1 PC
E	FLAT WASHER/ RONDELLE PLATE/ ARANDELA PLANA $\frac{5}{16}$ " DIAMETER x $\frac{3}{4}$ " x $\frac{1}{16}$ "		10 PCS
F	LOCK WASHER/ RONDELLE DE BLOCAGE/ ARANDELA DE BLOQUEO $\frac{5}{16}$ " DIAMETER x $\frac{1}{2}$ " x $\frac{1}{16}$ "		10 PCS
G	BOLT/ BOULON/ TORNILLO $\frac{5}{16}$ " DIAMETER x $1\frac{3}{4}$ " LENGTH		10 PCS
H	ALLEN KEY/ CLÉ ALLEN/ LLAVE INGLESA ALLEN $\frac{3}{16}$ "		1 PC
I	SCREW/ VIS/ TORNILLO M4 x $1\frac{1}{4}$ " LENGTH		8 PCS

### LIST OF PARTS AND HARDWARE/ LISTE DES PIÈCES ET DU MATÉRIEL/ LISTA DE PIEZAS Y HARDWARE

NO#/ NOMBRE/ NÚMERO	DESCRIPTION/ DESCRIPTION/ DESCRIPCIÓN		QUANTITY/ QUANTITÉ/ CANTIDAD
1	HEADBOARD/ TÊTE DE LIT/ CABECERA		1 PC
2	KD LEFT HEADBOARD LEG/ JAMBE GAUCHE DE TÊTE DE LIT KD/ PATA IZQUIERDA KD PARA CABEZERA		1 PC
3	KD RIGHT HEADBOARD LEG/ JAMBE DROITE DE TÊTE DE LIT KD/ PATA DERECHA KD PARA CABEZERA		1 PC
4	WOOD MENDING PLATE/ PLAQUE DE RÉPARATION/ PLACA DE REPARACIÓN		2 PCS
5	BOTTOM RAIL/ RAIL INFÉRIEUR/ RIEL INFERIOR		1 PC
6	FOOTBOARD/ PIED DE LIT/ ESTRIBO		1 PC
7	SIDE RAIL / RAIL LATÉRAL / CARRIL LATERAL		2 PCS
8	SLAT/ LATTE/ LISTÓN		4 PCS
9	SLAT SUPPORT LEG/ JAMBE D'APPUI/ PIERNA DE APOYO		4 PCS
10	BULB HOLDER/ PORTE-AMPOULE/ PORTALÁMPARAS		2 PCS
11	LAMP SHADE/ FORME DE LA LAMPE/ PANTALLA DE LÁMPARA		2 PCS
12	(OUTPUT: 12V DC Bulb-MAX:3W with E26/E27 SOCKET) LIGHT BULB/ AMPOULE/ BOMBILLA (NOT PROVIDED)		2 PCS

NOTE:  
SPIRIT LEVELER NOT INCLUDED BUT NEEDED TO EVEN THE FLOOR.  
SPIRIT LEVELER NON INCLUS MAIS NÉCESSAIRE MÊME LE SOL.  
NIVELADOR DE ESPÍRITU NO INCLUIDO PERO ES NECESARIO PARA INCLUSO EL PISO.

# ASSEMBLY INSTRUCTIONS INSTRUCTIONS DE MONTAGE INSTRUCCIONES DE MONTAJE

## QUEEN PANEL BED

Note:

Mark

Side rail

HB or FB

Step/ Étape/ Paso 10

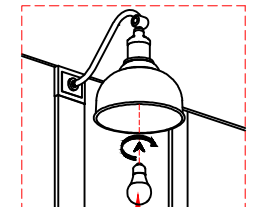
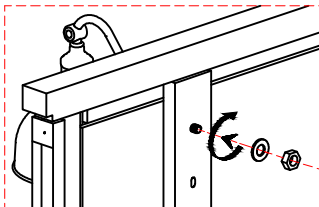
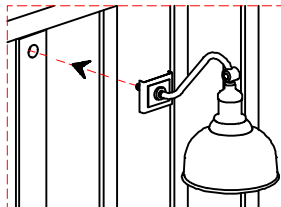
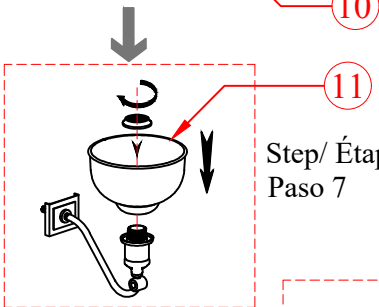
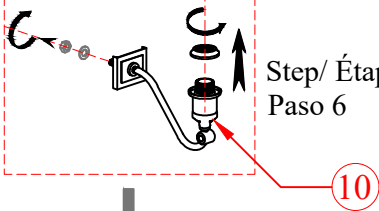

NOTE:  
MUST USE 3 Watts, 12 Volt DC Bulb with E26/E27 SOCKET.  
DOIT UTILISER UNE AMPOULE DE 3 WATTS, 12 VOLTS AVEC PRISE E26 / E27.  
DEBE USAR 3 WATTS, BOMBILLA DE 12 VOLTIOS CON ENCHUFE E26 / E27.

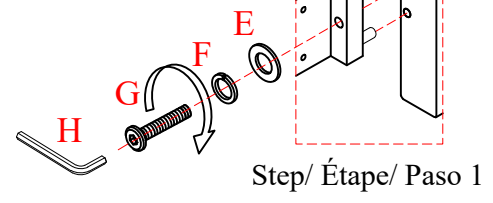
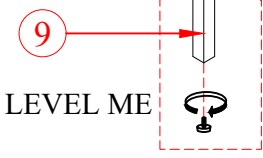
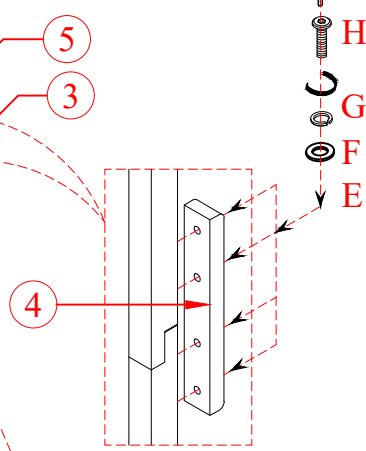
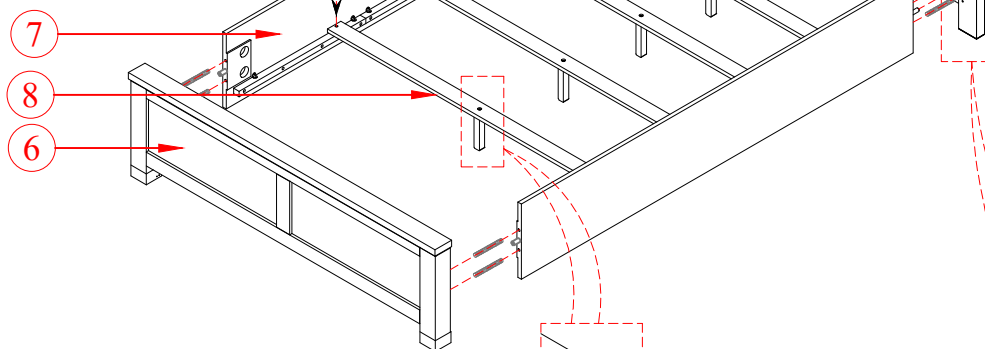
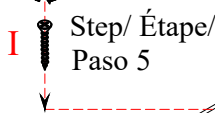
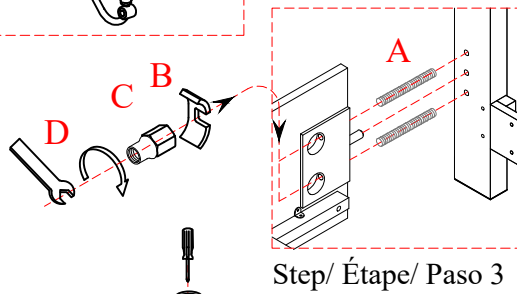

NOTE:  
SPIRIT LEVELER NOT INCLUDED BUT NEEDED TO EVEN THE FLOOR.  
SPIRIT LEVELER NON INCLUS MAIS NÉCESSAIRE MÊME LE SOL.  
NIVELADOR DE ESPÍRITU NO INCLUIDO PERO ES NECESARIO PARA INCLUSO EL PISO.

# ASSEMBLY INSTRUCTIONS INSTRUCTIONS DE MONTAGE INSTRUCCIONES DE MONTAJE

## QUEEN PANEL BED

### WIRING DIAGRAM

Step/ Étape/ Paso 11

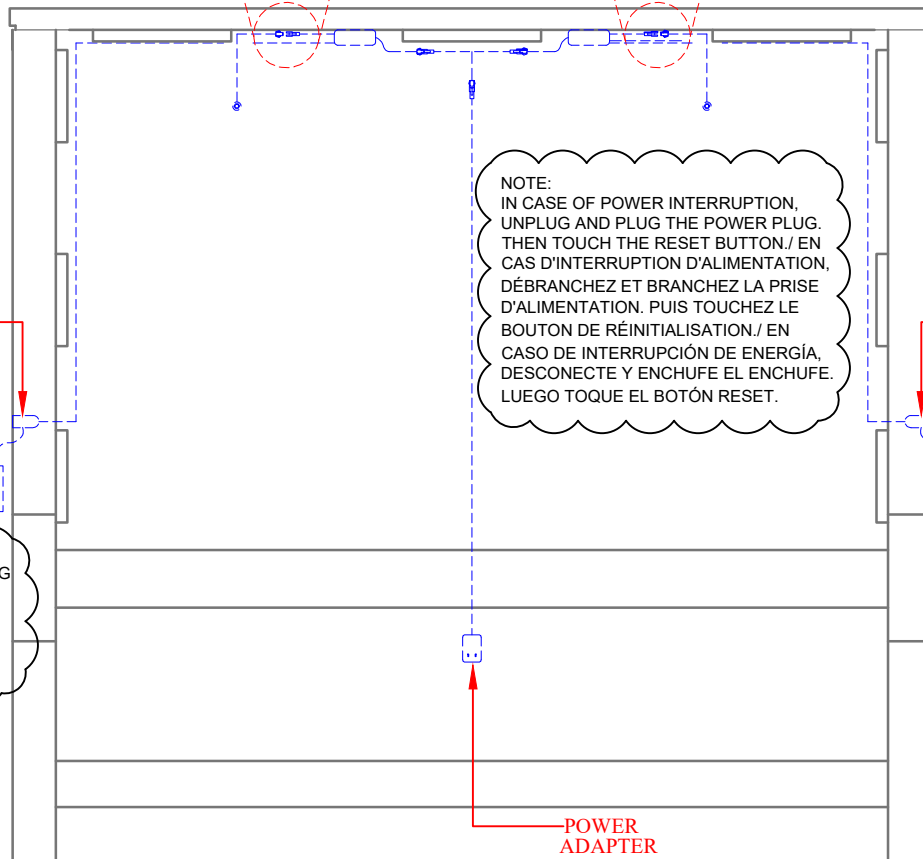
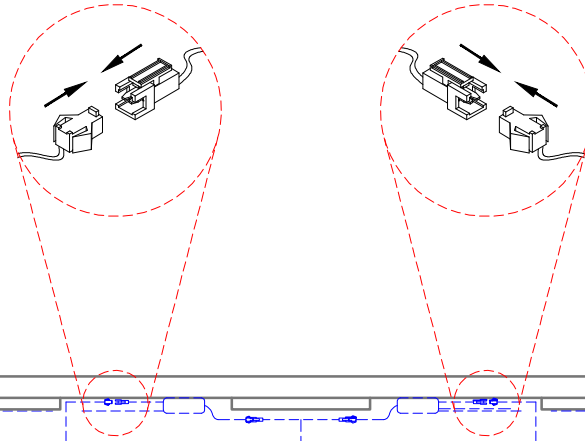

NOTE:  
SPIRIT LEVELER NOT INCLUDED BUT NEEDED TO EVEN THE FLOOR.  
SPIRIT LEVELER NON INCLUS MAIS NÉCESSAIRE MÊME LE SOL.  
NIVELADOR DE ESPÍRITU NO INCLUIDO PERO ES NECESARIO PARA INCLUSO EL PISO.

# ASSEMBLY INSTRUCTIONS INSTRUCTIONS DE MONTAGE INSTRUCCIONES DE MONTAJE

## QUEEN PANEL BED

**CAUTION:** PLEASE READ ALL INSTRUCTIONS BEFORE STARTING THE ASSEMBLY OF THIS PRODUCT. THESE PIECES ARE HEAVY. IN ORDER TO PREVENT PERSONAL INJURY AND ENSURE THAT THIS PRODUCT IS NOT DAMAGED DURING THE ASSEMBLY PROCESS, IT IS STRONGLY RECOMMENDED TO ENLIST THE ASSISTANCE OF ONE OR MORE PERSONS. IN CASE OF EXCESS STAIN, WIPE THE BOTTOM OF THE UNIT BEFORE PLACING ON ANY SURFACE.

**ATTENTION:** VEUILLEZ LIRE TOUTES LES INSTRUCTIONS AVANT DE COMMENCER L'ASSEMBLAGE DE CE PRODUIT. LES PIECES SONT LOURDES. POUR EVITER TOUTE BLESSURE ET POUR VOUS ASSURER QUE LE PRODUIT N'EST PAS ENDOMMAGE' PENDANT L'ASSEMBLAGE, NOUS VOUS RECOMMANDONS DE FAIRE APPEL A UNE OU PLUSIEURS AUTRES PERSONNES. EN CAS DE TACHE EXCESSIVE, ESSUYEZ LE FOND DE L'UNITE' AVANT LE PLACEMENT SUR N'IMPORTE QUELLE SURFACE.

**CUIDADO:** FAVOR DE LEER TODAS LAS INSTRUCCIONES ANTES DE ENSAMBLAR SU PRODUCTO, ESTAS PIEZAS SON PESADAS. PARA PREVENIR HERIDAS PERSONALES Y ASEGURAR QUE SU PRODUCTO NO SEA DANADO MIENTRAS ES ENSAMBLADO. SE RECOMIENDA LA ASISTENCIA DE UNA O MAS PERSONAS.

**WARNING:** PROTECTIVE GLIDE IS PLACED UNDER EACH LEG OF THE FURNITURE TO RESIST SCRATCHES ON FLOOR SURFACE. SOME FLOOR SURFACES CAN BE EXTRA SENSITIVE TO SCRATCHES AND MARKINGS, IF YOU ARE NOT SURE CONSULT WITH YOUR DEALER. AVERTISSEMENT. LES PIEDS DES MEUBLES SONT MUNIS DE PATINS DESTINES A PROTEGER LE PLANCHER. CERTAINS REVETEMENTS DE SOL PEUVENT ETRE TRES FRAGILES. EN CAS DE DOUTE. CONSULTER LE MARCHAND.

**NOTE:**

MUST USE 3 Watts, 12 Volt DC Bulb with E26/E27 SOCKET.  
DOIT UTILISER UNE AMPOULE DE 3 WATTS, 12 VOLTS DC AVEC PRISE E26 / E27.  
DEBE USAR 3 WATTS, BOMBILLA DE 12 VOLTIOS DC CON ENCHUFE E26 / E27.

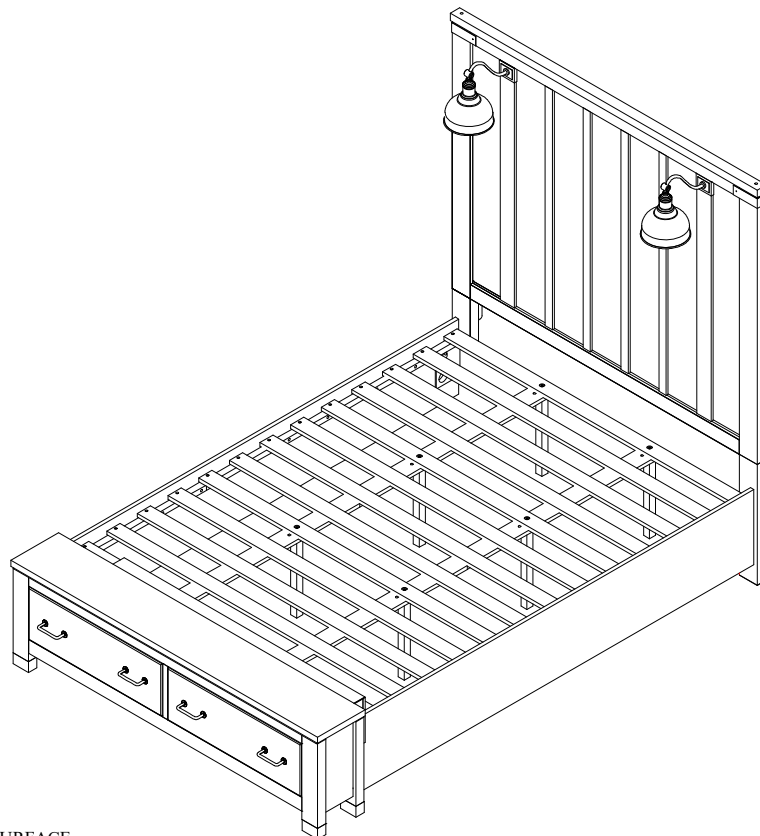









**NOTE:**  
ASSEMBLE UNIT ON A SOFT SURFACE.  
ASSEMBLEZ L'UNITE' SUR UNE SURFACE MOLLE.  
ENSAMBLE LA UNIDAD EN UNA SUPERFICIE PLANA Y SUAVE.

DO NOT TIGHTEN BOLTS UNTIL ALL PARTS AND HARDWARE OF THE UNIT ARE ASSEMBLED.  
NE SERREZ PAS LES BOULONS JUSQU'À CE QUE L'UNITE' SOIT COMPLÈTEMENT ASSEMBLÉE.  
NO APRIETE LOS TORNILLOS HASTA QUE LA UNIDAD ESTE COMPLETAMENTE ENSAMBLADA.















# ASSEMBLY INSTRUCTIONS INSTRUCTIONS DE MONTAGE INSTRUCCIONES DE MONTAJE

## QUEEN PANEL BED

### LIST OF PARTS AND HARDWARE/ LISTE DES PIÈCES ET DU MATÉRIEL/ LISTA DE PIEZAS Y HARDWARE

NO#/ NOMBRE/ NÚMERO	DESCRIPTION/ DESCRIPTION/ DESCRIPCIÓN		QUANTITY/ QUANTITÉ/ CANTIDAD
A	BOLT/ BOULON/ TORNILLO $\frac{5}{16}$ " DIAMETER x 4 $\frac{1}{2}$ " LENGTH		8 PCS
B	LOCK WASHER "C"/ RONDELLE DE BLOCAGE "C"/ ARANDELA DE BLOQUEO "C" $\frac{5}{16}$ " DIAMETER		8 PCS
C	NUT/ ÉCROU/ NUEZ $\frac{5}{16}$ " DIAMETER		8 PCS
D	WRENCH/ CLÉ/ LLAVE INGLESA $\frac{1}{2}$ "		1 PC
E	FLAT WASHER/ RONDELLE PLATE/ ARANDELA PLANA $\frac{5}{16}$ " DIAMETER x $\frac{3}{4}$ " x $\frac{1}{16}$ "		10 PCS
F	LOCK WASHER/ RONDELLE DE BLOCAGE/ ARANDELA DE BLOQUEO $\frac{5}{16}$ " DIAMETER x $\frac{1}{2}$ " x $\frac{1}{16}$ "		10 PCS
G	BOLT/ BOULON/ TORNILLO $\frac{5}{16}$ " DIAMETER x 1 $\frac{3}{4}$ " LENGTH		10 PCS
H	ALLEN KEY/ CLÉ ALLEN/ LLAVE INGLESA ALLEN $\frac{3}{16}$ "		1 PC
I	SCREW/ VIS/ TORNILLO M4 x 1 $\frac{1}{4}$ " LENGTH		28 PCS

### LIST OF PARTS AND HARDWARE/ LISTE DES PIÈCES ET DU MATÉRIEL/ LISTA DE PIEZAS Y HARDWARE

NO#/ NOMBRE/ NÚMERO	DESCRIPTION/ DESCRIPTION/ DESCRIPCIÓN		QUANTITY/ QUANTITÉ/ CANTIDAD
1	HEADBOARD/ TÊTE DE LIT/ CABECERA		1 PC
2	KD LEFT HEADBOARD LEG/ JAMBE GAUCHE DE TÊTE DE LIT KD/ PATA IZQUIERDA KD PARA CABEZERA		1 PC
3	KD RIGHT HEADBOARD LEG/ JAMBE DROITE DE TÊTE DE LIT KD/ PATA DERECHA KD PARA CABEZERA		1 PC
4	WOOD MENDING PLATE/ PLAQUE DE RÉPARATION/ PLACA DE REPARACIÓN		2 PCS
5	BOTTOM RAIL/ RAIL INFÉRIEUR/ RIEL INFERIOR		1 PC
6	FOOTBOARD/ PIED DE LIT/ ESTRIBO		1 PC
7	SIDE RAIL / RAIL LATÉRAL / CARRIL LATERAL		2 PCS
8	SLAT ROLL/ ROULEAU DE LATTES/ ROLLO DE LISTONES		13 PCS
9	BOTTOM SLAT "A"/ LATTE INFÉRIEURE "A"/ LISTÓN INFERIOR "A"		2 PCS
10	BOTTOM SLAT "B"/ LATTE INFÉRIEURE "B"/ LISTÓN INFERIOR "B"		2 PCS
11	SLAT SUPPORT LEG/ JAMBE D'APPUI/ PIERNA DE APOYO		6 PCS
12	BULB HOLDER/ PORTE-AMPOULE/ PORTALÁMPARAS		2 PCS
13	LAMP SHADE/ FORME DE LA LAMPE/ PANTALLA DE LÁMPARA		2 PCS
14	(OUTPUT: 12V-MAX DC Bulb:3W with E26/E27 SOCKET) LIGHT BULB/ AMPOULE/ BOMBILLA (NOT PROVIDED)		2 PCS

NOTE:  
SPIRIT LEVELER NOT INCLUDED BUT NEEDED TO EVEN THE FLOOR.  
SPIRIT LEVELER NON INCLUS MAIS NÉCESSAIRE MÊME LE SOL.  
NIVELADOR DE ESPÍRITU NO INCLUIDO PERO ES NECESARIO PARA INCLUSO EL PISO.

# ASSEMBLY INSTRUCTIONS INSTRUCTIONS DE MONTAGE INSTRUCCIONES DE MONTAJE

## QUEEN PANEL BED

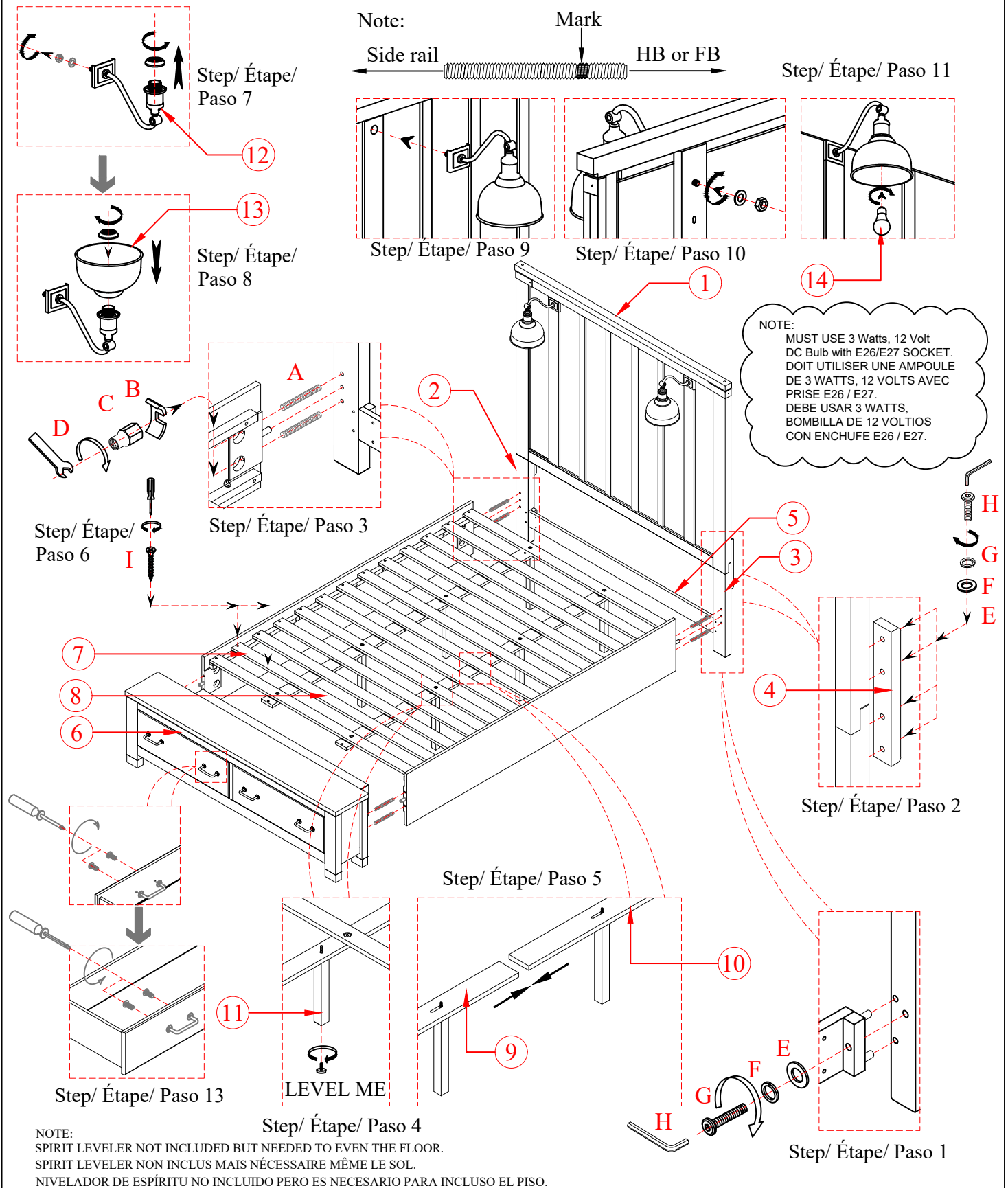

# ASSEMBLY INSTRUCTIONS INSTRUCTIONS DE MONTAGE INSTRUCCIONES DE MONTAJE

## QUEEN PANEL BED

### WIRING DIAGRAM

Step/ Étape/ Paso 11

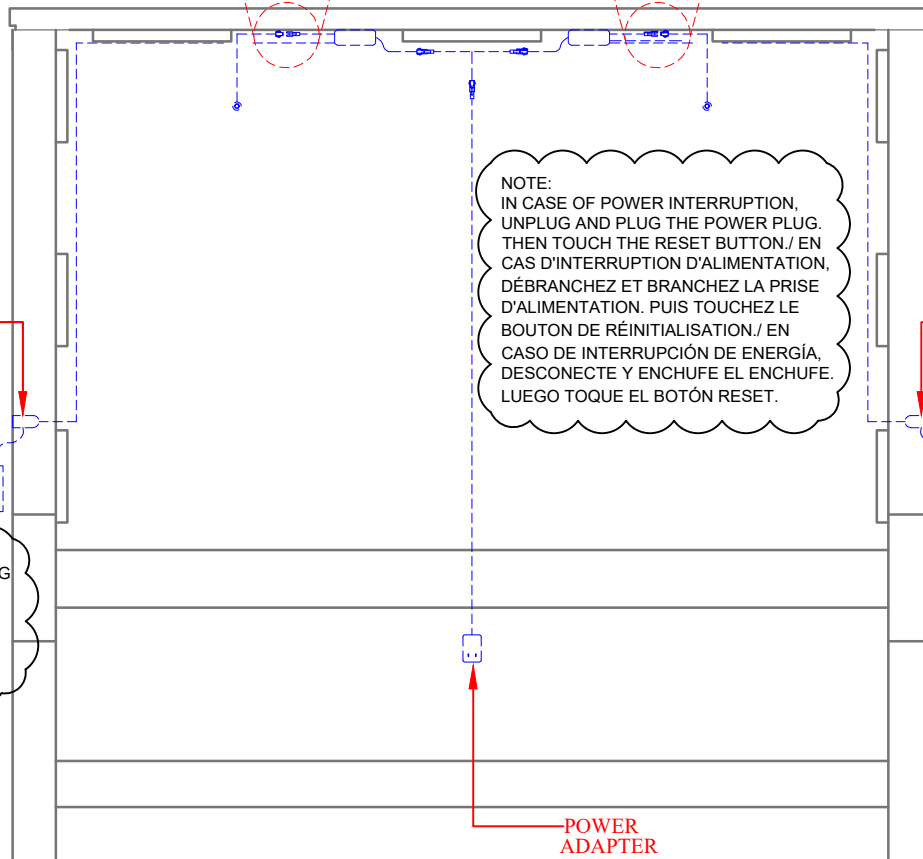
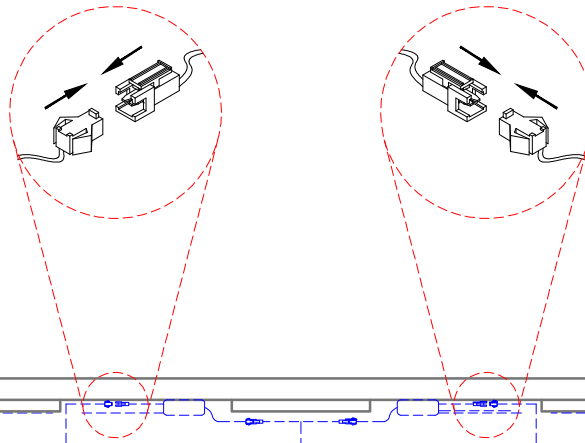

NOTE:  
IN CASE OF POWER INTERRUPTION,  
UNPLUG AND PLUG THE POWER PLUG.  
THEN TOUCH THE RESET BUTTON./ EN  
CAS D'INTERRUPTION D'ALIMENTATION,  
DÉBRANCHEZ ET BRANCHEZ LA PRISE  
D'ALIMENTATION. PUIS TOUCHEZ LE  
BOUTON DE RÉINITIALISATION./ EN  
CASO DE INTERRUPCIÓN DE ENERGÍA,  
DESCONECTE Y ENCHUFE EL ENCHUFE.  
LUEGO TOQUE EL BOTÓN RESET.

NOTE:  
DO NOT REMOVE THE HANG  
TAG/ NE PAS RETIRER  
L'ÉTIQUETTE DE  
SUSPENSION/  
NO RETIRE LA ETIQUETA  
COLGANTE

NOTE:  
DO NOT REMOVE THE HANG  
TAG/ NE PAS RETIRER  
L'ÉTIQUETTE DE  
SUSPENSION/  
NO RETIRE LA ETIQUETA  
COLGANTE

NOTE:  
SPIRIT LEVELER NOT INCLUDED BUT NEEDED TO EVEN THE FLOOR.  
SPIRIT LEVELER NON INCLUS MAIS NÉCESSAIRE MÊME LE SOL.  
NIVELADOR DE ESPÍRITU NO INCLUIDO PERO ES NECESARIO PARA INCLUSO EL PISO.

# ASSEMBLY INSTRUCTIONS INSTRUCTIONS DE MONTAGE INSTRUCCIONES DE MONTAJE

## QUEEN PANEL BED WITH METAL HEADBOARD

**CAUTION:** PLEASE READ ALL INSTRUCTIONS BEFORE STARTING THE ASSEMBLY OF THIS PRODUCT. THESE PIECES ARE HEAVY. IN ORDER TO PREVENT PERSONAL INJURY AND ENSURE THAT THIS PRODUCT IS NOT DAMAGED DURING THE ASSEMBLY PROCESS, IT IS STRONGLY RECOMMENDED TO ENLIST THE ASSISTANCE OF ONE OR MORE PERSONS. IN CASE OF EXCESS STAIN, WIPE THE BOTTOM OF THE UNIT BEFORE PLACING ON ANY SURFACE.

**ATTENTION:** VEUILLEZ LIRE TOUTES LES INSTRUCTIONS AVANT DE COMMENCER L'ASSEMBLAGE DE CE PRODUIT. LES PIECES SONT LOURDES. POUR EVITER TOUTE BLESSURE ET POUR VOUS. ASSURER QUE LE PRODUIT N'EST PAS ENDOMMAGE' PENDANT L'ASSEMBLAGE, NOUS VOUS RECOMMANDONS DE FAIRE APPEL A UNE OU PLUSIEURS AUTRES PERSONNES. EN CAS DE TACHE EXCESSIVE, ESSUYEZ LE FOND DE L'UNITE' AVANT LE PLACEMENT SUR N'IMPORTE QUELLE SURFACE.

**CUIDADO:** FAVOR DE LEER TODAS LAS INSTRUCCIONES ANTES DE ENSAMBLAR SU PRODUCTO, ESTAS. PIEZAS SON PESADAS. PARA PREVENIR HERIDAS PERSONALES Y ASEGURAR QUE SU PRODUCTO NO SEA DAN ADO MIENTRAS ES ENSAMBLADO. SE RECOMIENDA LA ASISTENCIA DE UNA O MAUS PERSONAS.

**WARNING:** PROTECTIVE GLIDE IS PLACED UNDER EACH LEG OF THE FURNITURE TO RESIST SCRATCHES ON FLOOR SURFACE. SOME FLOOR SURFACES CAN BE EXTRA SENSITIVE TO SCRATCHES AND MARKINGS, IF YOU ARE NOT SURE CONSULT WITH YOUR DEALER.  
AVERTISSEMENT. LES PIEDS DES MEUBLES SONT MUNIS DE PATINS DESTINES A PROTEGER LE PLANCHER. CERTAINS REVETEMENTS DE SOL PEUVENT ETRE TRES FRAGILES. EN CAS DE DOUTE. CONSULTER LE MARCHAND.

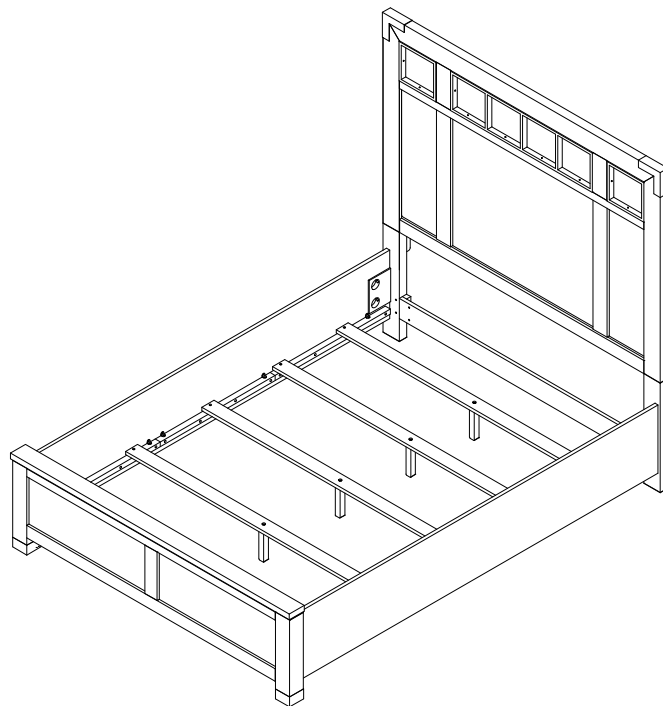









NOTE:  
ASSEMBLE UNIT ON A SOFT SURFACE.  
ASSEMBLEZ L'UNITÉ SUR UNE SURFACE MOLLE.  
ENSAMBLE LA UNIDAD EN UNA SUPERFICIE PLANA Y SUAVE.

DO NOT TIGHTEN BOLTS UNTIL **ALL PARTS AND HARDWARE OF** THE UNIT ARE ASSEMBLED.  
NE SERREZ PAS LES BOULONS JUSQU'À CE QUE L'UNITÉ SOIT COMPLÈTEMENT ASSEMBLÉE.  
NO APRIETE LOS TORNILLOS HASTA QUE LA UNIDAD ESTE COMPLETAMENTE ENSAMBLADA.









# ASSEMBLY INSTRUCTIONS INSTRUCTIONS DE MONTAGE INSTRUCCIONES DE MONTAJE

## QUEEN PANEL BED WITH METAL HEADBOARD

### LIST OF PARTS AND HARDWARE/ LISTE DES PIÈCES ET DU MATÉRIEL/ LISTA DE PIEZAS Y HARDWARE

NO#/ NOMBRE/ NÚMERO	DESCRIPTION/ DESCRIPTION/ DESCRIPCIÓN		QUANTITY/ QUANTITÉ/ CANTIDAD
A	BOLT/ BOULON/ TORNILLO 5/16" DIAMETER x 4 1/2" LENGTH		8 PCS
B	LOCK WASHER "C"/ RONDELLE DE BLOCAGE "C"/ ARANDELA DE BLOQUEO "C" 5/16" DIAMETER		8 PCS
C	NUT/ ÉCROU/ NUEZ 5/16" DIAMETER		8 PCS
D	WRENCH/ CLÉ/ LLAVE INGLESA 1/2"		1 PC
E	FLAT WASHER/ RONDELLE PLATE/ ARANDELA PLANA 5/16" DIAMETER x 3/4" x 1/16"		10 PCS
F	LOCK WASHER/ RONDELLE DE BLOCAGE/ ARANDELA DE BLOQUEO 5/16" DIAMETER x 1/2" x 1/16"		10 PCS
G	BOLT/ BOULON/ TORNILLO 5/16" DIAMETER x 1 3/4" LENGTH		10 PCS
H	ALLEN KEY/ CLÉ ALLEN/ LLAVE INGLESA ALLEN 3/16"		1 PC
I	SCREW/ VIS/ TORNILLO M4 x 1 1/4" LENGTH		8 PCS

### LIST OF PARTS AND HARDWARE/ LISTE DES PIÈCES ET DU MATÉRIEL/ LISTA DE PIEZAS Y HARDWARE

NO#/ NOMBRE/ NÚMERO	DESCRIPTION/ DESCRIPTION/ DESCRIPCIÓN		QUANTITY/ QUANTITÉ/ CANTIDAD
1	HEADBOARD/ TÊTE DE LIT/ CABECERA		1 PC
2	KD LEFT HEADBOARD LEG/ JAMBE GAUCHE DE TÊTE DE LIT KD/ PATA IZQUIERDA KD PARA CABEZERA		1 PC
3	KD RIGHT HEADBOARD LEG/ JAMBE DROITE DE TÊTE DE LIT KD/ PATA DERECHA KD PARA CABEZERA		1 PC
4	WOOD MENDING PLATE/ PLAQUE DE RÉPARATION/ PLACA DE REPARACIÓN		2 PCS
5	BOTTOM RAIL/ RAIL INFÉRIEUR/ RIEL INFERIOR		1 PC
6	FOOTBOARD/ PIED DE LIT/ ESTRIBO		1 PC
7	SIDE RAIL / RAIL LATÉRAL / CARRIL LATERAL		2 PCS
8	SLAT/ LATTE/ LISTÓN		4 PCS
9	SLAT SUPPORT LEG/ JAMBE D'APPUI/ PIERNA DE APOYO		4 PCS

NOTE:  
SPIRIT LEVELER NOT INCLUDED BUT NEEDED TO EVEN THE FLOOR.  
SPIRIT LEVELER NON INCLUS MAIS NÉCESSAIRE MÊME LE SOL.  
NIVELADOR DE ESPÍRITU NO INCLUIDO PERO ES NECESARIO PARA INCLUSO EL PISO.

# ASSEMBLY INSTRUCTIONS INSTRUCTIONS DE MONTAGE INSTRUCCIONES DE MONTAJE

## QUEEN PANEL BED WITH METAL HEADBOARD

Note:

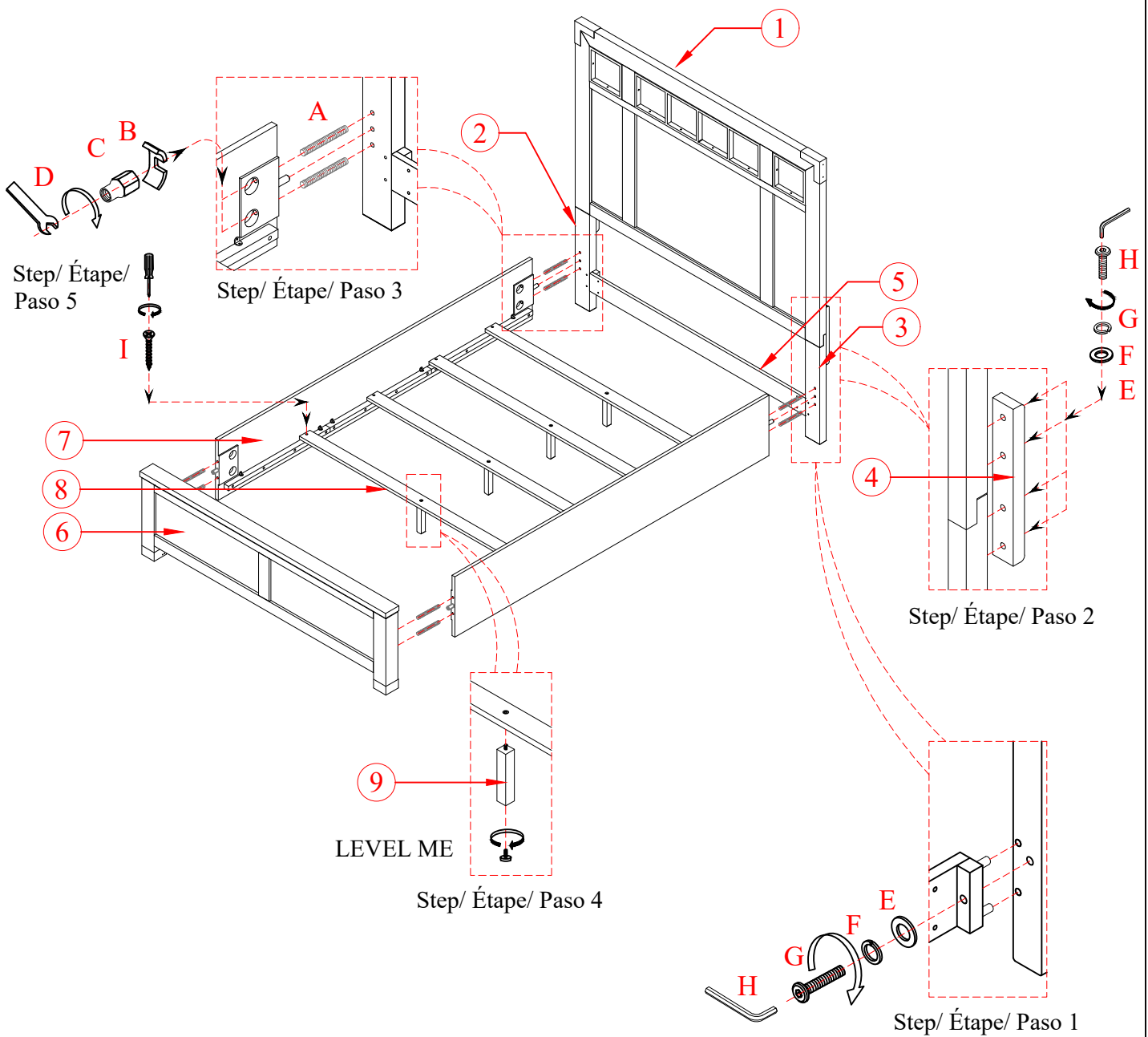

NOTE:  
SPIRIT LEVELER NOT INCLUDED BUT NEEDED TO EVEN THE FLOOR.  
SPIRIT LEVELER NON INCLUS MAIS NÉCESSAIRE MÊME LE SOL.  
NIVELADOR DE ESPÍRITU NO INCLUIDO PERO ES NECESARIO PARA INCLUSO EL PISO.

# ASSEMBLY INSTRUCTIONS INSTRUCTIONS DE MONTAGE INSTRUCCIONES DE MONTAJE

## QUEEN PANEL BED WITH METAL HEADBOARD

**CAUTION:** PLEASE READ ALL INSTRUCTIONS BEFORE STARTING THE ASSEMBLY OF THIS PRODUCT. THESE PIECES ARE HEAVY. IN ORDER TO PREVENT PERSONAL INJURY AND ENSURE THAT THIS PRODUCT IS NOT DAMAGED DURING THE ASSEMBLY PROCESS, IT IS STRONGLY RECOMMENDED TO ENLIST THE ASSISTANCE OF ONE OR MORE PERSONS. IN CASE OF EXCESS STAIN, WIPE THE BOTTOM OF THE UNIT BEFORE PLACING ON ANY SURFACE.

**ATTENTION:** VEUILLEZ LIRE TOUTES LES INSTRUCTIONS AVANT DE COMMENCER L'ASSEMBLAGE DE CE PRODUIT. LES PIECES SONT LOURDES. POUR EVITER TOUTE BLESSURE ET POUR VOUS. ASSURER QUE LE PRODUIT N'EST PAS ENDOMMAGE' PENDANT L'ASSEMBLAGE, NOUS VOUS RECOMMANDONS DE FAIRE APPEL A UNE OU PLUSIEURS AUTRES PERSONNES. EN CAS DE TACHE EXCESSIVE, ESSUYEZ LE FOND DE L'UNITE' AVANT LE PLACEMENT SUR N'IMPORTE QUELLE SURFACE.

**CUIDADO:** FAVOR DE LEER TODAS LAS INSTRUCCIONES ANTES DE ENSAMBLAR SU PRODUCTO, ESTAS. PIEZAS SON PESADAS. PARA PREVENIR HERIDAS PERSONALES Y ASEGURAR QUE SU PRODUCTO NO SEA DAN ADO MIENTRAS ES ENSAMBLADO. SE RECOMIENDA LA ASISTENCIA DE UNA O MAUS PERSONAS.

**WARNING:** PROTECTIVE GLIDE IS PLACED UNDER EACH LEG OF THE FURNITURE TO RESIST SCRATCHES ON FLOOR SURFACE. SOME FLOOR SURFACES CAN BE EXTRA SENSITIVE TO SCRATCHES AND MARKINGS, IF YOU ARE NOT SURE CONSULT WITH YOUR DEALER.  
AVERTISSEMENT. LES PIEDS DES MEUBLES SONT MUNIS DE PATINS DESTINES A PROTEGER LE PLANCHER. CERTAINS REVETEMENTS DE SOL PEUVENT ETRE TRES FRAGILES. EN CAS DE DOUTE. CONSULTER LE MARCHAND.

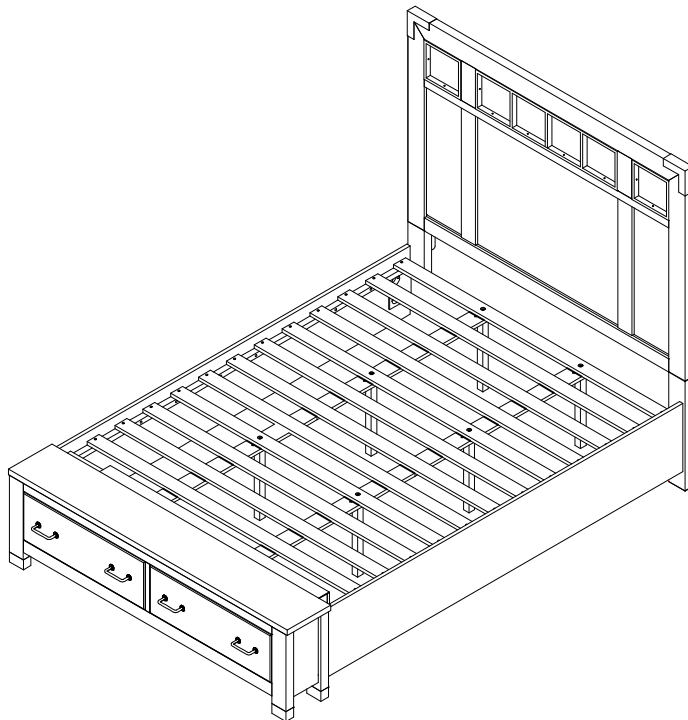









NOTE:  
ASSEMBLE UNIT ON A SOFT SURFACE.  
ASSEMBLEZ L'UNITÉ SUR UNE SURFACE MOLLE.  
ENSAMBLE LA UNIDAD EN UNA SUPERFICIE PLANA Y SUAVE.

DO NOT TIGHTEN BOLTS UNTIL **ALL PARTS AND HARDWARE OF** THE UNIT ARE ASSEMBLED.  
NE SERREZ PAS LES BOULONS JUSQU'À CE QUE L'UNITÉ SOIT COMPLÈTEMENT ASSEMBLÉE.  
NO APRIETE LOS TORNILLOS HASTA QUE LA UNIDAD ESTE COMPLETAMENTE ENSAMBLADA.











# ASSEMBLY INSTRUCTIONS INSTRUCTIONS DE MONTAGE INSTRUCCIONES DE MONTAJE

## QUEEN PANEL BED WITH METAL HEADBOARD

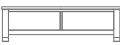
### LIST OF PARTS AND HARDWARE/ LISTE DES PIÈCES ET DU MATÉRIEL/ LISTA DE PIEZAS Y HARDWARE

NO#/ NOMBRE/ NÚMERO	DESCRIPTION/ DESCRIPTION/ DESCRIPCIÓN		QUANTITY/ QUANTITÉ/ CANTIDAD
A	BOLT/ BOULON/ TORNILLO 5/16" DIAMETER x 4 1/2" LENGTH		8 PCS
B	LOCK WASHER "C"/ RONDELLE DE BLOCAGE "C"/ ARANDELA DE BLOQUEO "C" 5/16" DIAMETER		8 PCS
C	NUT/ ÉCROU/ NUEZ 5/16" DIAMETER		8 PCS
D	WRENCH/ CLÉ/ LLAVE INGLESA 1/2"		1 PC
E	FLAT WASHER/ RONDELLE PLATE/ ARANDELA PLANA 5/16" DIAMETER x 3/4" x 1/16"		10 PCS
F	LOCK WASHER/ RONDELLE DE BLOCAGE/ ARANDELA DE BLOQUEO 5/16" DIAMETER x 1/2" x 1/16"		10 PCS
G	BOLT/ BOULON/ TORNILLO 5/16" DIAMETER x 1 3/4" LENGTH		10 PCS
H	ALLEN KEY/ CLÉ ALLEN/ LLAVE INGLESA ALLEN 3/16"		1 PC
I	SCREW/ VIS/ TORNILLO M4 x 1 1/4" LENGTH		28 PCS

### LIST OF PARTS AND HARDWARE/ LISTE DES PIÈCES ET DU MATÉRIEL/ LISTA DE PIEZAS Y HARDWARE

NO#/ NOMBRE/ NÚMERO	DESCRIPTION/ DESCRIPTION/ DESCRIPCIÓN		QUANTITY/ QUANTITÉ/ CANTIDAD
1	HEADBOARD/ TÊTE DE LIT/ CABECERA		1 PC
2	KD LEFT HEADBOARD LEG/ JAMBE GAUCHE DE TÊTE DE LIT KD/ PATA IZQUIERDA KD PARA CABEZERA		1 PC
3	KD RIGHT HEADBOARD LEG/ JAMBE DROITE DE TÊTE DE LIT KD/ PATA DERECHA KD PARA CABEZERA		1 PC
4	WOOD MENDING PLATE/ PLAQUE DE RÉPARATION/ PLACA DE REPARACIÓN		2 PCS
5	BOTTOM RAIL/ RAIL INFÉRIEUR/ RIEL INFERIOR		1 PC
6	FOOTBOARD/ PIED DE LIT/ ESTRIBO		1 PC
7	SIDE RAIL / RAIL LATÉRAL / CARRIL LATERAL		2 PCS
8	SLAT ROLL/ ROULEAU DE LATTES/ ROLLO DE LISTONES		13 PCS
9	BOTTOM SLAT "A"/ LATTE INFÉRIEURE "A"/ LISTÓN INFERIOR "A"		2 PCS
10	BOTTOM SLAT "B"/ LATTE INFÉRIEURE "B"/ LISTÓN INFERIOR "B"		2 PCS
11	SLAT SUPPORT LEG/ JAMBE D'APPUI/ PIERNA DE APOYO		6 PCS

NOTE:  
SPIRIT LEVELER NOT INCLUDED BUT NEEDED TO EVEN THE FLOOR.  
SPIRIT LEVELER NON INCLUS MAIS NÉCESSAIRE MÊME LE SOL.  
NIVELADOR DE ESPÍRITU NO INCLUIDO PERO ES NECESARIO PARA INCLUSO EL PISO.

# ASSEMBLY INSTRUCTIONS INSTRUCTIONS DE MONTAGE INSTRUCCIONES DE MONTAJE

## QUEEN PANEL BED WITH METAL HEADBOARD

Note:

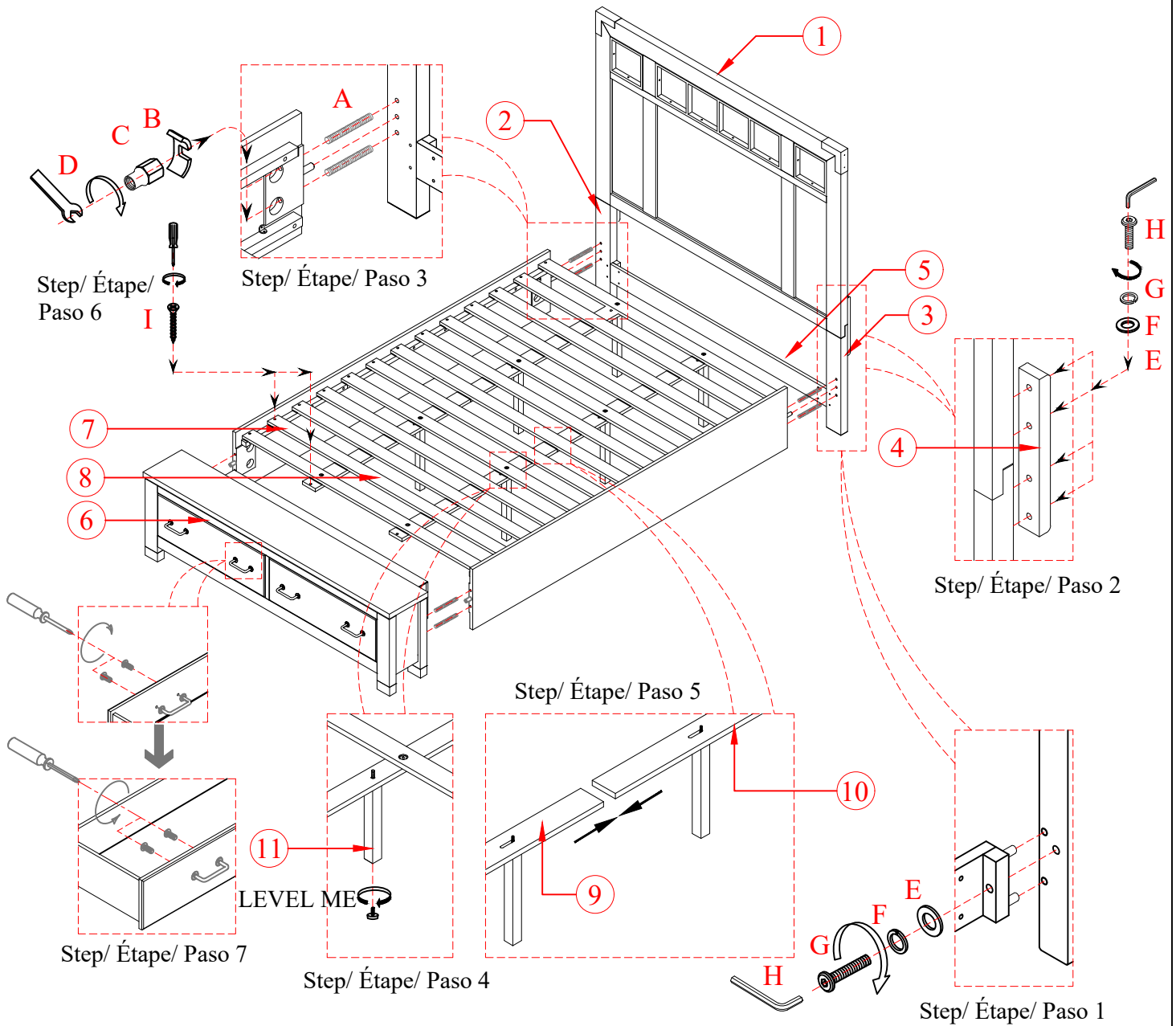
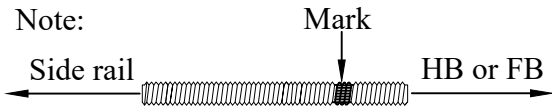

NOTE:  
SPIRIT LEVELER NOT INCLUDED BUT NEEDED TO EVEN THE FLOOR.  
SPIRIT LEVELER NON INCLUS MAIS NÉCESSAIRE MÊME LE SOL.  
NIVELADOR DE ESPÍRITU NO INCLUIDO PERO ES NECESARIO PARA INCLUSO EL PISO.

# ASSEMBLY INSTRUCTIONS INSTRUCTIONS DE MONTAGE INSTRUCCIONES DE MONTAJE

## KING PANEL BED

**CAUTION:** PLEASE READ ALL INSTRUCTIONS BEFORE STARTING THE ASSEMBLY OF THIS PRODUCT. THESE PIECES ARE HEAVY. IN ORDER TO PREVENT PERSONAL INJURY AND ENSURE THAT THIS PRODUCT IS NOT DAMAGED DURING THE ASSEMBLY PROCESS, IT IS STRONGLY RECOMMENDED TO ENLIST THE ASSISTANCE OF ONE OR MORE PERSONS. IN CASE OF EXCESS STAIN, WIPE THE BOTTOM OF THE UNIT BEFORE PLACING ON ANY SURFACE.

**ATTENTION:** VEUILLEZ LIRE TOUTES LES INSTRUCTIONS AVANT DE COMMENCER L'ASSEMBLAGE DE CE PRODUIT. LES PIECES SONT LOURDES. POUR EVITER TOUTE BLESSURE ET POUR VOUS ASSURER QUE LE PRODUIT N'EST PAS ENDOMMAGE' PENDANT L'ASSEMBLAGE, NOUS VOUS RECOMMANDONS DE FAIRE APPEL A UNE OU PLUSIEURS AUTRES PERSONNES. EN CAS DE TACHE EXCESSIVE, ESSUYEZ LE FOND DE L'UNITE' AVANT LE PLACEMENT SUR N'IMPORTE QUELLE SURFACE.

**CUIDADO:** FAVOR DE LEER TODAS LAS INSTRUCCIONES ANTES DE ENSAMBLAR SU PRODUCTO, ESTAS PIEZAS SON PESADAS. PARA PREVENIR HERIDAS PERSONALES Y ASEGURAR QUE SU PRODUCTO NO SEA DANADO MIENTRAS ES ENSAMBLADO. SE RECOMIENDA LA ASISTENCIA DE UNA O MAS PERSONAS.

**WARNING:** PROTECTIVE GLIDE IS PLACED UNDER EACH LEG OF THE FURNITURE TO RESIST SCRATCHES ON FLOOR SURFACE. SOME FLOOR SURFACES CAN BE EXTRA SENSITIVE TO SCRATCHES AND MARKINGS, IF YOU ARE NOT SURE CONSULT WITH YOUR DEALER. AVERTISSEMENT. LES PIEDS DES MEUBLES SONT MUNIS DE PATINS DESTINES A PROTEGER LE PLANCHER. CERTAINS REVETEMENTS DE SOL PEUVENT ETRE TRES FRAGILES. EN CAS DE DOUTE. CONSULTER LE MARCHAND.

**NOTE:**

MUST USE 3 Watts, 12 Volt DC Bulb with E26/E27 SOCKET.  
DOIT UTILISER UNE AMPOULE DE 3 WATTS, 12 VOLTS DC AVEC PRISE E26 / E27.  
DEBE USAR 3 WATTS, BOMBILLA DE 12 VOLTIOS DC CON ENCHUFE E26 / E27.

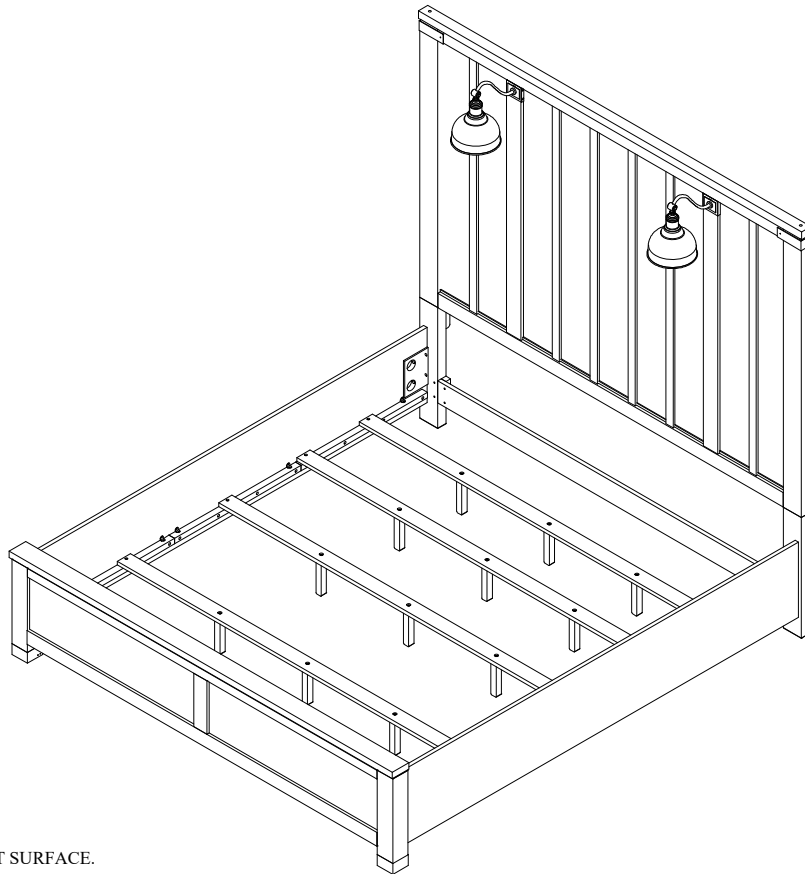









**NOTE:**  
ASSEMBLE UNIT ON A SOFT SURFACE.  
ASSEMBLEZ L'UNITE' SUR UNE SURFACE MOLLE.  
ENSAMBLE LA UNIDAD EN UNA SUPERFICIE PLANA Y SUAVE.

DO NOT TIGHTEN BOLTS UNTIL ALL PARTS AND HARDWARE OF THE UNIT ARE ASSEMBLED.  
NE SERREZ PAS LES BOULONS JUSQU'À CE QUE L'UNITE' SOIT COMPLÈTEMENT ASSEMBLÉE.  
NO APRIETE LOS TORNILLOS HASTA QUE LA UNIDAD ESTE COMPLETAMENTE ENSAMBLADA.











# ASSEMBLY INSTRUCTIONS INSTRUCTIONS DE MONTAGE INSTRUCCIONES DE MONTAJE

## KING PANEL BED

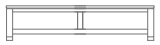
### LIST OF PARTS AND HARDWARE/ LISTE DES PIÈCES ET DU MATÉRIEL/ LISTA DE PIEZAS Y HARDWARE

NO#/ NOMBRE/ NÚMERO	DESCRIPTION/ DESCRIPTION/ DESCRIPCIÓN		QUANTITY/ QUANTITÉ/ CANTIDAD
A	BOLT/ BOULON/ TORNILLO $\frac{5}{16}$ " DIAMETER x 4 $\frac{1}{2}$ " LENGTH		8 PCS
B	LOCK WASHER "C"/ RONDELLE DE BLOCAGE "C"/ ARANDELA DE BLOQUEO "C" $\frac{5}{16}$ " DIAMETER		8 PCS
C	NUT/ ÉCROU/ NUEZ $\frac{5}{16}$ " DIAMETER		8 PCS
D	WRENCH/ CLÉ/ LLAVE INGLESA $\frac{1}{2}$ "		1 PC
E	FLAT WASHER/ RONDELLE PLATE/ ARANDELA PLANA $\frac{5}{16}$ " DIAMETER x $\frac{3}{4}$ " x $\frac{1}{16}$ "		10 PCS
F	LOCK WASHER/ RONDELLE DE BLOCAGE/ ARANDELA DE BLOQUEO $\frac{5}{16}$ " DIAMETER x $\frac{1}{2}$ " x $\frac{1}{16}$ "		10 PCS
G	BOLT/ BOULON/ TORNILLO $\frac{5}{16}$ " DIAMETER x 1 $\frac{3}{4}$ " LENGTH		10 PCS
H	ALLEN KEY/ CLÉ ALLEN/ LLAVE INGLESA ALLEN $\frac{3}{16}$ "		1 PC
I	SCREW/ VIS/ TORNILLO M4 x 1 $\frac{1}{4}$ " LENGTH		8 PCS

### LIST OF PARTS AND HARDWARE/ LISTE DES PIÈCES ET DU MATÉRIEL/ LISTA DE PIEZAS Y HARDWARE

NO#/ NOMBRE/ NÚMERO	DESCRIPTION/ DESCRIPTION/ DESCRIPCIÓN		QUANTITY/ QUANTITÉ/ CANTIDAD
1	HEADBOARD/ TÊTE DE LIT/ CABECERA		1 PC
2	KD LEFT HEADBOARD LEG/ JAMBE GAUCHE DE TÊTE DE LIT KD/ PATA IZQUIERDA KD PARA CABEZERA		1 PC
3	KD RIGHT HEADBOARD LEG/ JAMBE DROITE DE TÊTE DE LIT KD/ PATA DERECHA KD PARA CABEZERA		1 PC
4	WOOD MENDING PLATE/ PLAQUE DE RÉPARATION/ PLACA DE REPARACIÓN		2 PCS
5	BOTTOM RAIL/ RAIL INFÉRIEUR/ RIEL INFERIOR		1 PC
6	FOOTBOARD/ PIED DE LIT/ ESTRIBO		1 PC
7	SIDE RAIL / RAIL LATÉRAL / CARRIL LATERAL		2 PCS
8	SLAT/ LATTE/ LISTÓN		4 PCS
9	SLAT SUPPORT LEG/ JAMBE D'APPUI/ PIERNA DE APOYO		12 PCS
10	BULB HOLDER/ PORTE-AMPOULE/ PORTALÁMPARAS		2 PCS
11	LAMP SHADE/ FORME DE LA LAMPE/ PANTALLA DE LÁMPARA		2 PCS
12	(OUTPUT: 12V-MAX DC Bulb:3W with E26/E27 SOCKET) LIGHT BULB/ AMPOULE/ BOMBILLA (NOT PROVIDED)		2 PCS

NOTE:  
SPIRIT LEVELER NOT INCLUDED BUT NEEDED TO EVEN THE FLOOR.  
SPIRIT LEVELER NON INCLUS MAIS NÉCESSAIRE MÊME LE SOL.  
NIVELADOR DE ESPÍRITU NO INCLUIDO PERO ES NECESARIO PARA INCLUSO EL PISO.

# ASSEMBLY INSTRUCTIONS INSTRUCTIONS DE MONTAGE INSTRUCCIONES DE MONTAJE

## KING PANEL BED

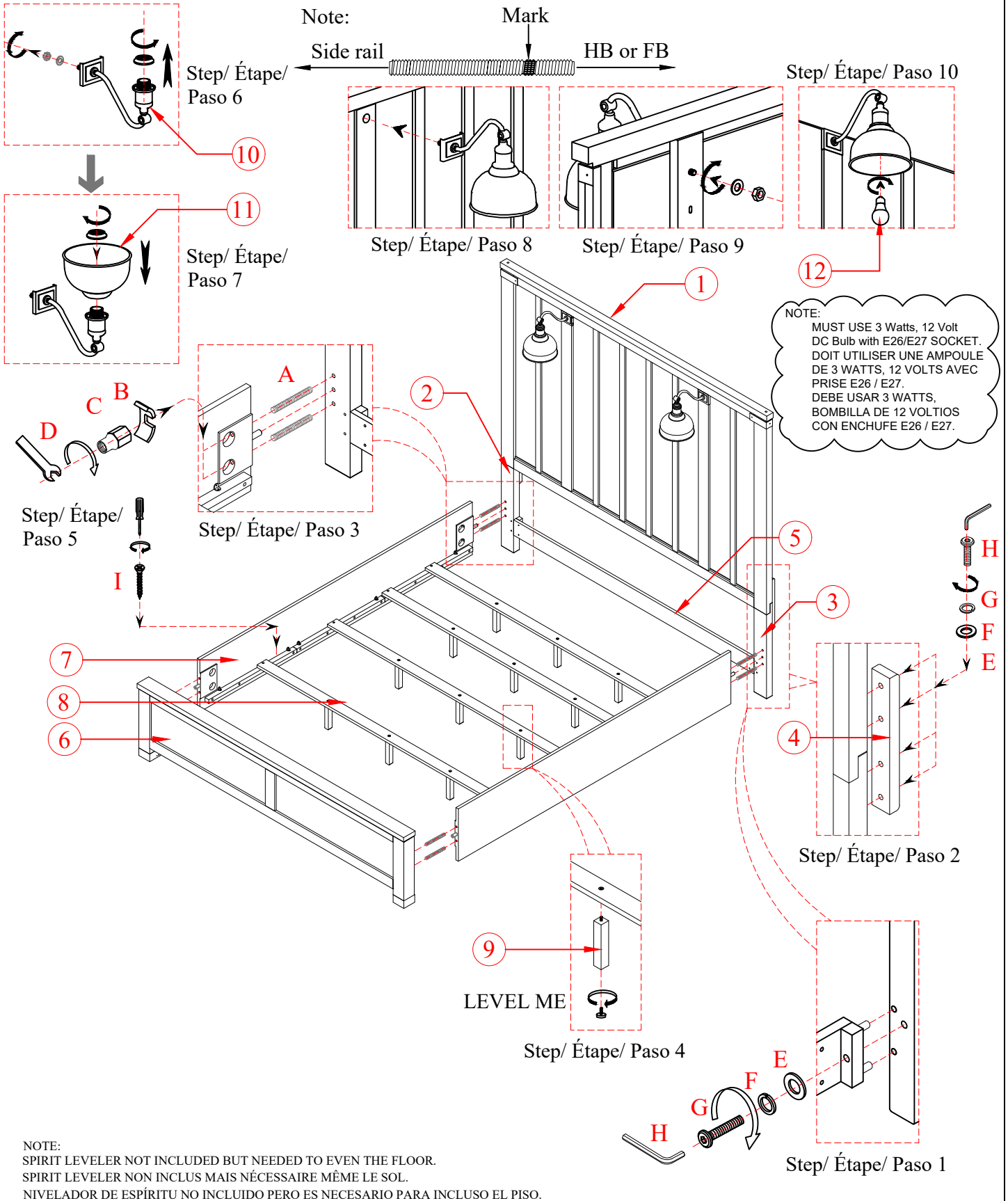

# ASSEMBLY INSTRUCTIONS INSTRUCTIONS DE MONTAGE INSTRUCCIONES DE MONTAJE

## KING PANEL BED

### WIRING DIAGRAM

Step/ Étape/ Paso 11

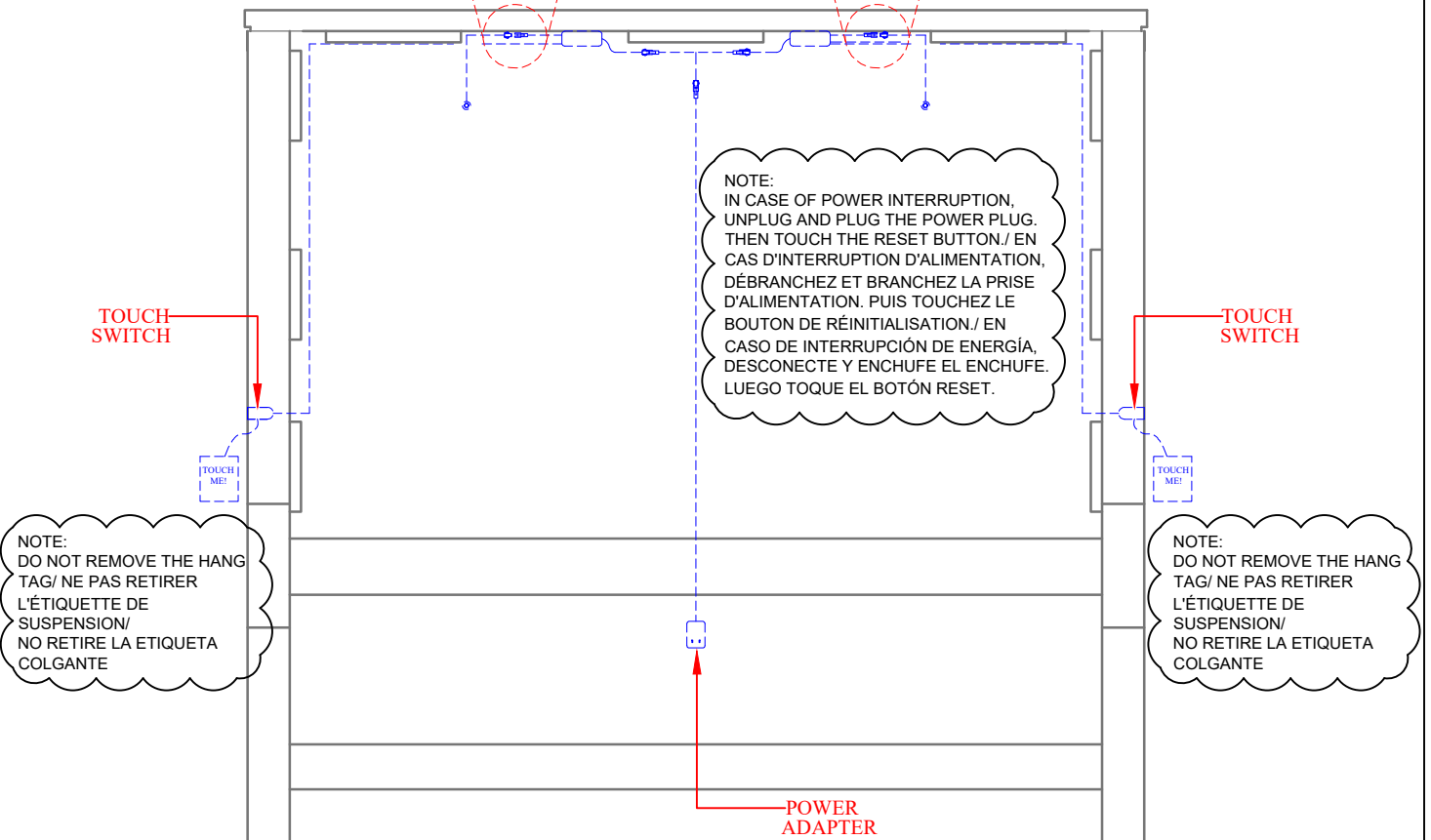
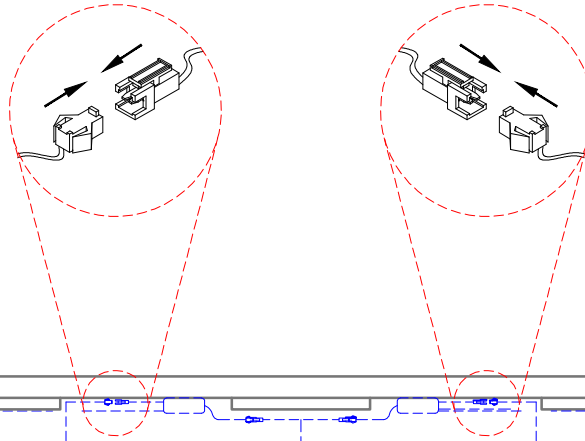

NOTE:  
SPIRIT LEVELER NOT INCLUDED BUT NEEDED TO EVEN THE FLOOR.  
SPIRIT LEVELER NON INCLUS MAIS NÉCESSAIRE MÊME LE SOL.  
NIVELADOR DE ESPÍRITU NO INCLUIDO PERO ES NECESARIO PARA INCLUSO EL PISO.

# ASSEMBLY INSTRUCTIONS INSTRUCTIONS DE MONTAGE INSTRUCCIONES DE MONTAJE

## KING PANEL BED

**CAUTION:** PLEASE READ ALL INSTRUCTIONS BEFORE STARTING THE ASSEMBLY OF THIS PRODUCT. THESE PIECES ARE HEAVY. IN ORDER TO PREVENT PERSONAL INJURY AND ENSURE THAT THIS PRODUCT IS NOT DAMAGED DURING THE ASSEMBLY PROCESS, IT IS STRONGLY RECOMMENDED TO ENLIST THE ASSISTANCE OF ONE OR MORE PERSONS. IN CASE OF EXCESS STAIN, WIPE THE BOTTOM OF THE UNIT BEFORE PLACING ON ANY SURFACE.

**ATTENTION:** VEUILLEZ LIRE TOUTES LES INSTRUCTIONS AVANT DE COMMENCER L'ASSEMBLAGE DE CE PRODUIT. LES PIECES SONT LOURDES. POUR EVITER TOUTE BLESSURE ET POUR VOUS ASSURER QUE LE PRODUIT N'EST PAS ENDOMMAGE' PENDANT L'ASSEMBLAGE, NOUS VOUS RECOMMANDONS DE FAIRE APPEL A UNE OU PLUSIEURS AUTRES PERSONNES. EN CAS DE TACHE EXCESSIVE, ESSUYEZ LE FOND DE L'UNITE' AVANT LE PLACEMENT SUR N'IMPORTE QUELLE SURFACE.

**CUIDADO:** FAVOR DE LEER TODAS LAS INSTRUCCIONES ANTES DE ENSAMBLAR SU PRODUCTO, ESTAS PIEZAS SON PESADAS. PARA PREVENIR HERIDAS PERSONALES Y ASEGURAR QUE SU PRODUCTO NO SEA DAN ADO MIENTRAS ES ENSAMBLADO. SE RECOMIENDA LA ASISTENCIA DE UNA O MAUS PERSONAS.

**WARNING:** PROTECTIVE GLIDE IS PLACED UNDER EACH LEG OF THE FURNITURE TO RESIST SCRATCHES ON FLOOR SURFACE. SOME FLOOR SURFACES CAN BE EXTRA SENSITIVE TO SCRATCHES AND MARKINGS, IF YOU ARE NOT SURE CONSULT WITH YOUR DEALER.  
AVERTISSEMENT. LES PIEDS DES MEUBLES SONT MUNIS DE PATINS DESTINES A PROTEGER LE PLANCHER. CERTAINS REVETEMENTS DE SOL PEUVENT ETRE TRES FRAGILES. EN CAS DE DOUTE. CONSULTER LE MARCHAND.

**NOTE:**

MUST USE 3 Watts, 12 Volt DC Bulb with E26/E27 SOCKET.  
DOIT UTILISER UNE AMPOULE DE 3 WATTS, 12 VOLTS DC AVEC PRISE E26 / E27.  
DEBE USAR 3 WATTS, BOMBILLA DE 12 VOLTIOS DC CON ENCHUFE E26 / E27.

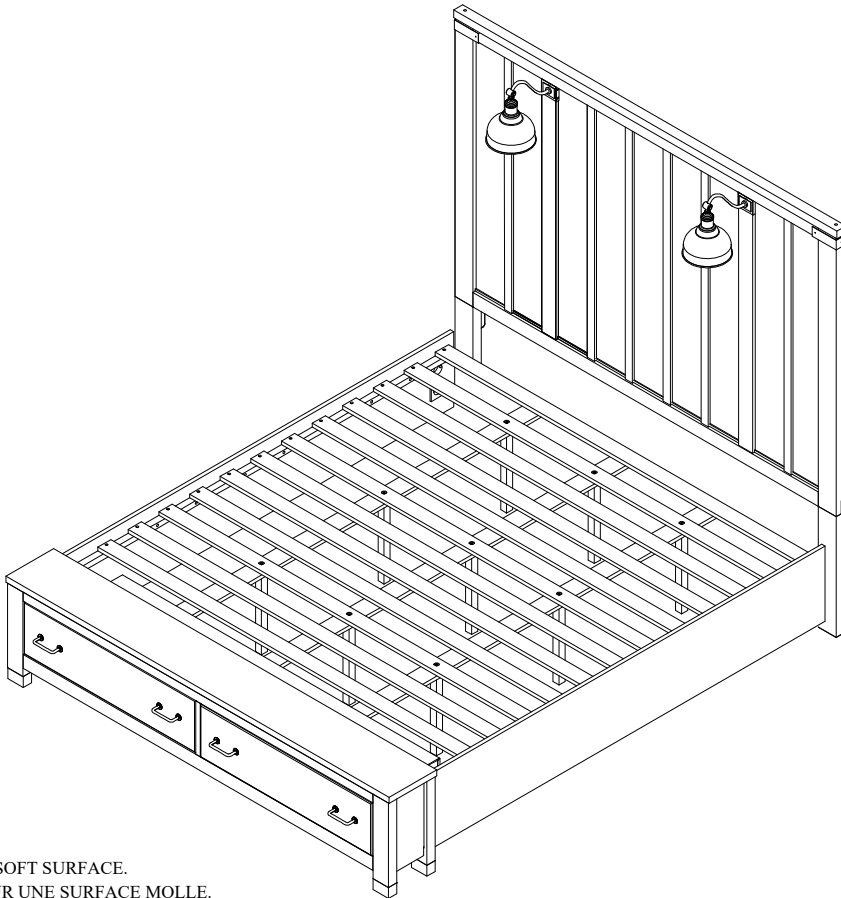









**NOTE:**  
ASSEMBLE UNIT ON A SOFT SURFACE.  
ASSEMBLEZ L'UNITE' SUR UNE SURFACE MOLLE.  
ENSAMBLE LA UNIDAD EN UNA SUPERFICIE PLANA Y SUAVE.

DO NOT TIGHTEN BOLTS UNTIL ALL PARTS AND HARDWARE OF THE UNIT ARE ASSEMBLED.  
NE SERREZ PAS LES BOULONS JUSQU'À CE QUE L'UNITE' SOIT COMPLÈTEMENT ASSEMBLÉE.  
NO APRIETE LOS TORNILLOS HASTA QUE LA UNIDAD ESTE COMPLETAMENTE ENSAMBLADA.











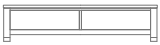

# ASSEMBLY INSTRUCTIONS INSTRUCTIONS DE MONTAGE INSTRUCCIONES DE MONTAJE

## KING PANEL BED

### LIST OF PARTS AND HARDWARE/ LISTE DES PIÈCES ET DU MATÉRIEL/ LISTA DE PIEZAS Y HARDWARE

NO#/ NOMBRE/ NÚMERO	DESCRIPTION/ DESCRIPTION/ DESCRIPCIÓN		QUANTITY/ QUANTITÉ/ CANTIDAD
A	BOLT/ BOULON/ TORNILLO $\frac{5}{16}$ " DIAMETER x 4 $\frac{1}{2}$ " LENGTH		8 PCS
B	LOCK WASHER "C"/ RONDELLE DE BLOCAGE "C"/ ARANDELA DE BLOQUEO "C" $\frac{5}{16}$ " DIAMETER		8 PCS
C	NUT/ ÉCROU/ NUEZ $\frac{5}{16}$ " DIAMETER		8 PCS
D	WRENCH/ CLÉ/ LLAVE INGLESA $\frac{1}{2}$ "		1 PC
E	FLAT WASHER/ RONDELLE PLATE/ ARANDELA PLANA $\frac{5}{16}$ " DIAMETER x $\frac{3}{4}$ " x $\frac{1}{16}$ "		10 PCS
F	LOCK WASHER/ RONDELLE DE BLOCAGE/ ARANDELA DE BLOQUEO $\frac{5}{16}$ " DIAMETER x $\frac{1}{2}$ " x $\frac{1}{16}$ "		10 PCS
G	BOLT/ BOULON/ TORNILLO $\frac{5}{16}$ " DIAMETER x 1 $\frac{3}{4}$ " LENGTH		10 PCS
H	ALLEN KEY/ CLÉ ALLEN/ LLAVE INGLESA ALLEN $\frac{3}{16}$ "		1 PC
I	SCREW/ VIS/ TORNILLO M4 x 1 $\frac{1}{4}$ " LENGTH		29 PCS

### LIST OF PARTS AND HARDWARE/ LISTE DES PIÈCES ET DU MATÉRIEL/ LISTA DE PIEZAS Y HARDWARE

NO#/ NOMBRE/ NÚMERO	DESCRIPTION/ DESCRIPTION/ DESCRIPCIÓN		QUANTITY/ QUANTITÉ/ CANTIDAD
1	HEADBOARD/ TÊTE DE LIT/ CABECERA		1 PC
2	KD LEFT HEADBOARD LEG/ JAMBE GAUCHE DE TÊTE DE LIT KD/ PATA IZQUIERDA KD PARA CABEZERA		1 PC
3	KD RIGHT HEADBOARD LEG/ JAMBE DROITE DE TÊTE DE LIT KD/ PATA DERECHA KD PARA CABEZERA		1 PC
4	WOOD MENDING PLATE/ PLAQUE DE RÉPARATION/ PLACA DE REPARACIÓN		2 PCS
5	BOTTOM RAIL/ RAIL INFÉRIEUR/ RIEL INFERIOR		1 PC
6	FOOTBOARD/ PIED DE LIT/ ESTRIBO		1 PC
7	SIDE RAIL / RAIL LATÉRAL / CARRIL LATERAL		2 PCS
8	SLAT ROLL/ ROULEAU DE LATTES/ ROLLO DE LISTONES		13 PCS
9	BOTTOM SLAT "A"/ LATTE INFÉRIEURE "A"/ LISTÓN INFERIOR "A"		2 PCS
10	BOTTOM SLAT "B"/ LATTE INFÉRIEURE "B"/ LISTÓN INFERIOR "B"		2 PCS
11	SLAT SUPPORT LEG/ JAMBE D'APPUI/ PIERNA DE APOYO		6 PCS
12	BULB HOLDER/ PORTE-AMPOULE/ PORTALÁMPARAS		2 PCS
13	LAMP SHADE/ FORME DE LA LAMPE/ PANTALLA DE LÁMPARA		2 PCS
14	(OUTPUT: 12V-MAX DC Bulb:3W with E26/E27 SOCKET) LIGHT BULB/ AMPOULE/ BOMBILLA (NOT PROVIDED)		2 PCS

NOTE:  
SPIRIT LEVELER NOT INCLUDED BUT NEEDED TO EVEN THE FLOOR.  
SPIRIT LEVELER NON INCLUS MAIS NÉCESSAIRE MÊME LE SOL.  
NIVELADOR DE ESPÍRITU NO INCLUIDO PERO ES NECESARIO PARA INCLUSO EL PISO.

# ASSEMBLY INSTRUCTIONS INSTRUCTIONS DE MONTAGE INSTRUCCIONES DE MONTAJE

## KING PANEL BED

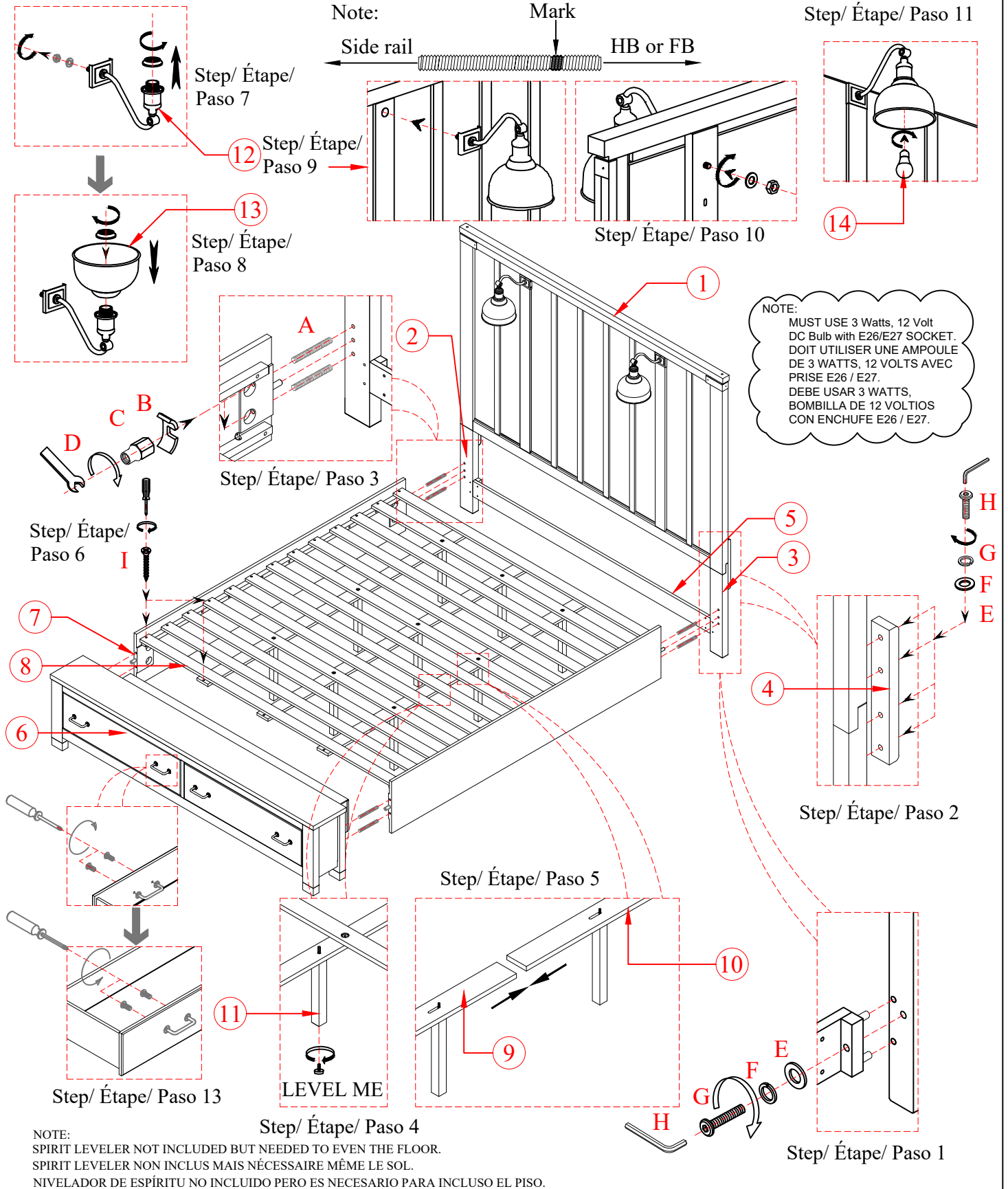

# ASSEMBLY INSTRUCTIONS INSTRUCTIONS DE MONTAGE INSTRUCCIONES DE MONTAJE

## KING PANEL BED

### WIRING DIAGRAM

Step/ Étape/ Paso 11

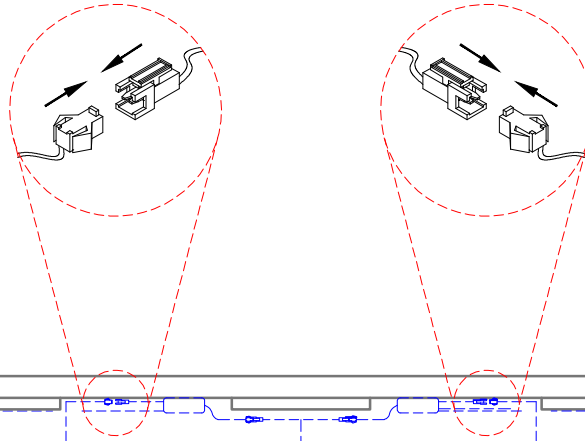

NOTE:  
IN CASE OF POWER INTERRUPTION,  
UNPLUG AND PLUG THE POWER PLUG.  
THEN TOUCH THE RESET BUTTON./ EN  
CAS D'INTERRUPTION D'ALIMENTATION,  
DÉBRANCHEZ ET BRANCHEZ LA PRISE  
D'ALIMENTATION. PUIS TOUCHEZ LE  
BOUTON DE RÉINITIALISATION./ EN  
CASO DE INTERRUPCIÓN DE ENERGÍA,  
DESCONECTE Y ENCHUFE EL ENCHUFE.  
LUEGO TOQUE EL BOTÓN RESET.

NOTE:  
DO NOT REMOVE THE HANG  
TAG/ NE PAS RETIRER  
L'ÉTIQUETTE DE  
SUSPENSION/  
NO RETIRE LA ETIQUETA  
COLGANTE

NOTE:  
DO NOT REMOVE THE HANG  
TAG/ NE PAS RETIRER  
L'ÉTIQUETTE DE  
SUSPENSION/  
NO RETIRE LA ETIQUETA  
COLGANTE

NOTE:  
SPIRIT LEVELER NOT INCLUDED BUT NEEDED TO EVEN THE FLOOR.  
SPIRIT LEVELER NON INCLUS MAIS NÉCESSAIRE MÊME LE SOL.  
NIVELADOR DE ESPÍRITU NO INCLUIDO PERO ES NECESARIO PARA INCLUSO EL PISO.

# ASSEMBLY INSTRUCTIONS INSTRUCTIONS DE MONTAGE INSTRUCCIONES DE MONTAJE

## KING PANEL BED WITH METAL HEADBOARD

**CAUTION:** PLEASE READ ALL INSTRUCTIONS BEFORE STARTING THE ASSEMBLY OF THIS PRODUCT. THESE PIECES ARE HEAVY. IN ORDER TO PREVENT PERSONAL INJURY AND ENSURE THAT THIS PRODUCT IS NOT DAMAGED DURING THE ASSEMBLY PROCESS, IT IS STRONGLY RECOMMENDED TO ENLIST THE ASSISTANCE OF ONE OR MORE PERSONS. IN CASE OF EXCESS STAIN, WIPE THE BOTTOM OF THE UNIT BEFORE PLACING ON ANY SURFACE.

**ATTENTION:** VEUILLEZ LIRE TOUTES LES INSTRUCTIONS AVANT DE COMMENCER L'ASSEMBLAGE DE CE PRODUIT. LES PIECES SONT LOURDES. POUR EVITER TOUTE BLESSURE ET POUR VOUS ASSURER QUE LE PRODUIT N'EST PAS ENDOMMAGE' PENDANT L'ASSEMBLAGE, NOUS VOUS RECOMMANDONS DE FAIRE APPEL A UNE OU PLUSIEURS AUTRES PERSONNES. EN CAS DE TACHE EXCESSIVE, ESSUYEZ LE FOND DE L'UNITE' AVANT LE PLACEMENT SUR N'IMPORTE QUELLE SURFACE.

**CUIDADO:** FAVOR DE LEER TODAS LAS INSTRUCCIONES ANTES DE ENSAMBLAR SU PRODUCTO, ESTAS PIEZAS SON PESADAS. PARA PREVENIR HERIDAS PERSONALES Y ASEGURAR QUE SU PRODUCTO NO SEA DANADO MIENTRAS ES ENSAMBLADO. SE RECOMIENDA LA ASISTENCIA DE UNA O MAS PERSONAS.

**WARNING:** PROTECTIVE GLIDE IS PLACED UNDER EACH LEG OF THE FURNITURE TO RESIST SCRATCHES ON FLOOR SURFACE. SOME FLOOR SURFACES CAN BE EXTRA SENSITIVE TO SCRATCHES AND MARKINGS, IF YOU ARE NOT SURE CONSULT WITH YOUR DEALER. AVERTISSEMENT. LES PIEDS DES MEUBLES SONT MUNIS DE PATINS DESTINES A PROTEGER LE PLANCHER. CERTAINS REVETEMENTS DE SOL PEUVENT ETRE TRES FRAGILES. EN CAS DE DOUTE. CONSULTER LE MARCHAND.

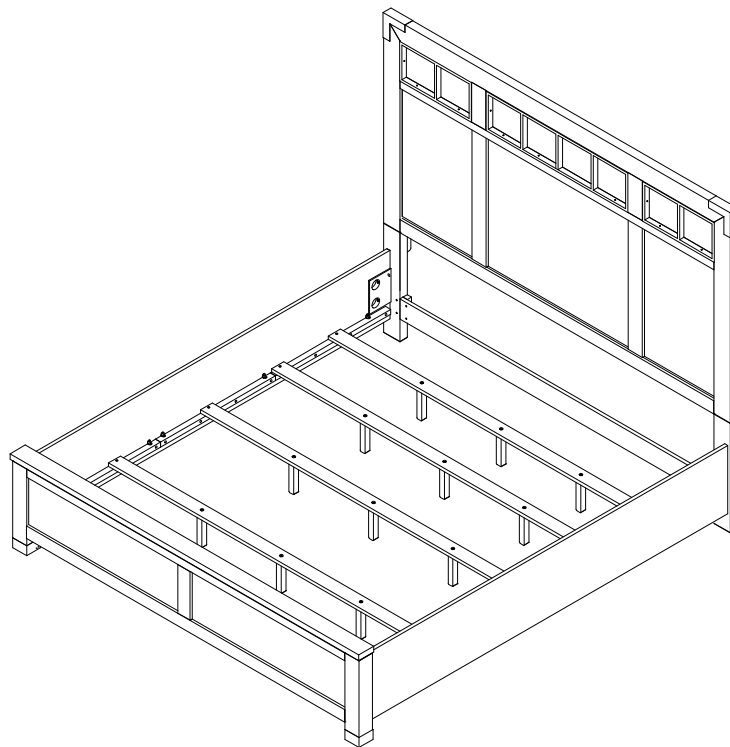









NOTE:  
ASSEMBLE UNIT ON A SOFT SURFACE.  
ASSEMBLEZ L'UNITÉ SUR UNE SURFACE MOLLE.  
ENSAMBLE LA UNIDAD EN UNA SUPERFICIE PLANA Y SUAVE.

DO NOT TIGHTEN BOLTS UNTIL ALL PARTS AND HARDWARE OF THE UNIT ARE ASSEMBLED.  
NE SERREZ PAS LES BOULONS JUSQU'À CE QUE L'UNITÉ SOIT COMPLÈTEMENT ASSEMBLÉE.  
NO APRIETE LOS TORNILLOS HASTA QUE LA UNIDAD ESTE COMPLETAMENTE ENSAMBLADA.









# ASSEMBLY INSTRUCTIONS INSTRUCTIONS DE MONTAGE INSTRUCCIONES DE MONTAJE

## KING PANEL BED WITH METAL HEADBOARD

### LIST OF PARTS AND HARDWARE/ LISTE DES PIÈCES ET DU MATÉRIEL/ LISTA DE PIEZAS Y HARDWARE

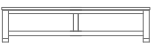
NO#/ NOMBRE/ NÚMERO	DESCRIPTION/ DESCRIPTION/ DESCRIPCIÓN		QUANTITY/ QUANTITÉ/ CANTIDAD
A	BOLT/ BOULON/ TORNILLO $\frac{5}{16}$ " DIAMETER x $4\frac{1}{2}$ " LENGTH		8 PCS
B	LOCK WASHER "C"/ RONDELLE DE BLOCAGE "C"/ ARANDELA DE BLOQUEO "C" $\frac{5}{16}$ " DIAMETER		8 PCS
C	NUT/ ÉCROU/ NUEZ $\frac{5}{16}$ " DIAMETER		8 PCS
D	WRENCH/ CLÉ/ LLAVE INGLESA $\frac{1}{2}$ "		1 PC
E	FLAT WASHER/ RONDELLE PLATE/ ARANDELA PLANA $\frac{5}{16}$ " DIAMETER x $\frac{3}{4}$ " x $\frac{1}{16}$ "		10 PCS
F	LOCK WASHER/ RONDELLE DE BLOCAGE/ ARANDELA DE BLOQUEO $\frac{5}{16}$ " DIAMETER x $\frac{1}{2}$ " x $\frac{1}{16}$ "		10 PCS
G	BOLT/ BOULON/ TORNILLO $\frac{5}{16}$ " DIAMETER x $1\frac{3}{4}$ " LENGTH		10 PCS
H	ALLEN KEY/ CLÉ ALLEN/ LLAVE INGLESA ALLEN $\frac{3}{16}$ "		1 PC
I	SCREW/ VIS/ TORNILLO M4 x $1\frac{1}{4}$ " LENGTH		8 PCS

### LIST OF PARTS AND HARDWARE/ LISTE DES PIÈCES ET DU MATÉRIEL/ LISTA DE PIEZAS Y HARDWARE

NO#/ NOMBRE/ NÚMERO	DESCRIPTION/ DESCRIPTION/ DESCRIPCIÓN		QUANTITY/ QUANTITÉ/ CANTIDAD
1	HEADBOARD/ TÊTE DE LIT/ CABECERA		1 PC
2	KD LEFT HEADBOARD LEG/ JAMBE GAUCHE DE TÊTE DE LIT KD/ PATA IZQUIERDA KD PARA CABEZERA		1 PC
3	KD RIGHT HEADBOARD LEG/ JAMBE DROITE DE TÊTE DE LIT KD/ PATA DERECHA KD PARA CABEZERA		1 PC
4	WOOD MENDING PLATE/ PLAQUE DE RÉPARATION/ PLACA DE REPARACIÓN		2 PCS
5	BOTTOM RAIL/ RAIL INFÉRIEUR/ RIEL INFERIOR		1 PC
6	FOOTBOARD/ PIED DE LIT/ ESTRIBO		1 PC
7	SIDE RAIL / RAIL LATÉRAL / CARRIL LATERAL		2 PCS
8	SLAT/ LATTE/ LISTÓN		4 PCS
9	SLAT SUPPORT LEG/ JAMBE D'APPUI/ PIERNA DE APOYO		12 PCS

NOTE:  
SPIRIT LEVELER NOT INCLUDED BUT NEEDED TO EVEN THE FLOOR.  
SPIRIT LEVELER NON INCLUS MAIS NÉCESSAIRE MÊME LE SOL.  
NIVELADOR DE ESPÍRITU NO INCLUIDO PERO ES NECESARIO PARA INCLUSO EL PISO.

# ASSEMBLY INSTRUCTIONS INSTRUCTIONS DE MONTAGE INSTRUCCIONES DE MONTAJE

## KING PANEL BED WITH METAL HEADBOARD

Note:

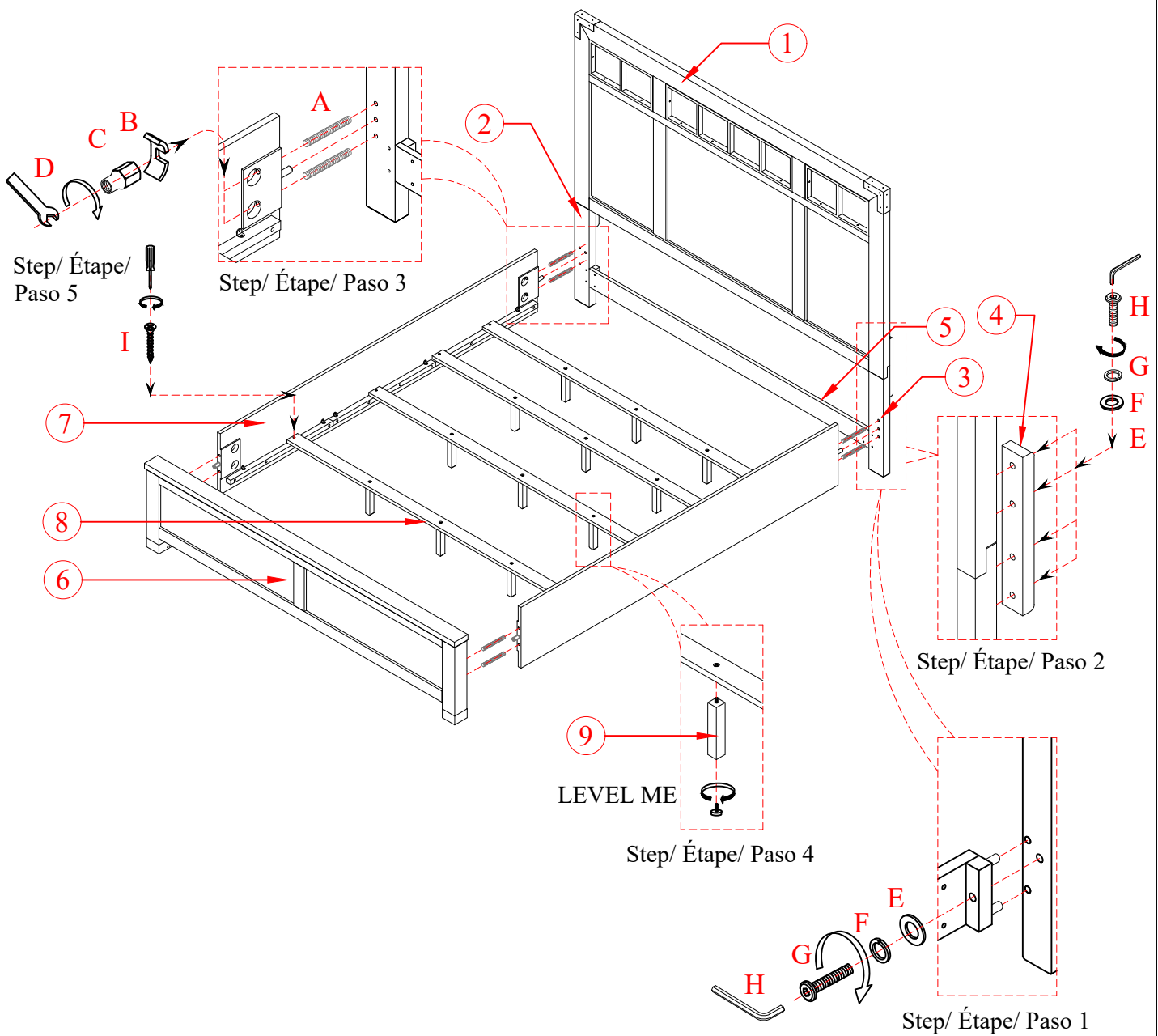

NOTE:  
SPIRIT LEVELER NOT INCLUDED BUT NEEDED TO EVEN THE FLOOR.  
SPIRIT LEVELER NON INCLUS MAIS NÉCESSAIRE MÊME LE SOL.  
NIVELADOR DE ESPÍRITU NO INCLUIDO PERO ES NECESARIO PARA INCLUSO EL PISO.

# ASSEMBLY INSTRUCTIONS INSTRUCTIONS DE MONTAGE INSTRUCCIONES DE MONTAJE

## KING PANEL BED WITH METAL HEADBOARD

**CAUTION:** PLEASE READ ALL INSTRUCTIONS BEFORE STARTING THE ASSEMBLY OF THIS PRODUCT. THESE PIECES ARE HEAVY. IN ORDER TO PREVENT PERSONAL INJURY AND ENSURE THAT THIS PRODUCT IS NOT DAMAGED DURING THE ASSEMBLY PROCESS, IT IS STRONGLY RECOMMENDED TO ENLIST THE ASSISTANCE OF ONE OR MORE PERSONS. IN CASE OF EXCESS STAIN, WIPE THE BOTTOM OF THE UNIT BEFORE PLACING ON ANY SURFACE.

**ATTENTION:** VEUILLEZ LIRE TOUTES LES INSTRUCTIONS AVANT DE COMMENCER L'ASSEMBLAGE DE CE PRODUIT. LES PIECES SONT LOURDES. POUR EVITER TOUTE BLESSURE ET POUR VOUS. ASSURER QUE LE PRODUIT N'EST PAS ENDOMMAGE' PENDANT L'ASSEMBLAGE, NOUS VOUS RECOMMANDONS DE FAIRE APPEL A UNE OU PLUSIEURS AUTRES PERSONNES. EN CAS DE TACHE EXCESSIVE, ESSUYEZ LE FOND DE L'UNITE' AVANT LE PLACEMENT SUR N'IMPORTE QUELLE SURFACE.

**CUIDADO:** FAVOR DE LEER TODAS LAS INSTRUCCIONES ANTES DE ENSAMBLAR SU PRODUCTO, ESTAS. PIEZAS SON PESADAS. PARA PREVENIR HERIDAS PERSONALES Y ASEGURAR QUE SU PRODUCTO NO SEA DAN ADO MIENTRAS ES ENSAMBLADO. SE RECOMIENDA LA ASISTENCIA DE UNA O MAUS PERSONAS.

**WARNING:** PROTECTIVE GLIDE IS PLACED UNDER EACH LEG OF THE FURNITURE TO RESIST SCRATCHES ON FLOOR SURFACE. SOME FLOOR SURFACES CAN BE EXTRA SENSITIVE TO SCRATCHES AND MARKINGS, IF YOU ARE NOT SURE CONSULT WITH YOUR DEALER.  
AVERTISSEMENT. LES PIEDS DES MEUBLES SONT MUNIS DE PATINS DESTINES A PROTEGER LE PLANCHER. CERTAINS REVETEMENTS DE SOL PEUVENT ETRE TRES FRAGILES. EN CAS DE DOUTE. CONSULTER LE MARCHAND.

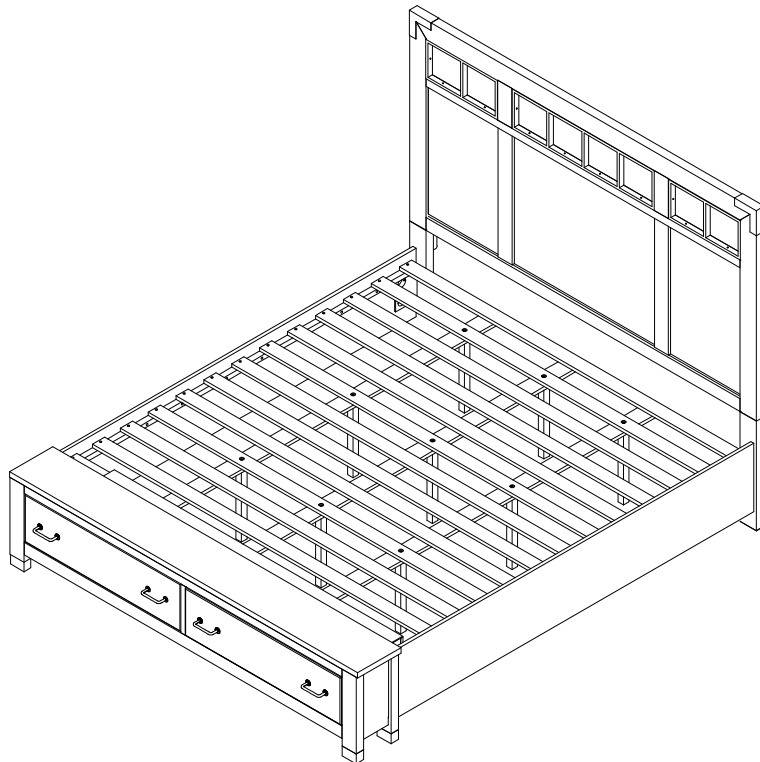









NOTE:  
ASSEMBLE UNIT ON A SOFT SURFACE.  
ASSEMBLEZ L'UNITÉ SUR UNE SURFACE MOLLE.  
ENSAMBLE LA UNIDAD EN UNA SUPERFICIE PLANA Y SUAVE.

DO NOT TIGHTEN BOLTS UNTIL ALL PARTS AND HARDWARE OF THE UNIT ARE ASSEMBLED.  
NE SERREZ PAS LES BOULONS JUSQU'À CE QUE L'UNITÉ SOIT COMPLÈTEMENT ASSEMBLÉE.  
NO APRIETE LOS TORNILLOS HASTA QUE LA UNIDAD ESTE COMPLETAMENTE ENSAMBLADA.











# ASSEMBLY INSTRUCTIONS INSTRUCTIONS DE MONTAGE INSTRUCCIONES DE MONTAJE

## KING PANEL BED WITH METAL HEADBOARD

### LIST OF PARTS AND HARDWARE/ LISTE DES PIÈCES ET DU MATÉRIEL/ LISTA DE PIEZAS Y HARDWARE

NO#/ NOMBRE/ NÚMERO	DESCRIPTION/ DESCRIPTION/ DESCRIPCIÓN		QUANTITY/ QUANTITÉ/ CANTIDAD
A	BOLT/ BOULON/ TORNILLO $\frac{5}{16}$ " DIAMETER x 4 $\frac{1}{2}$ " LENGTH		8 PCS
B	LOCK WASHER "C"/ RONDELLE DE BLOCAGE "C"/ ARANDELA DE BLOQUEO "C" $\frac{5}{16}$ " DIAMETER		8 PCS
C	NUT/ ÉCROU/ NUEZ $\frac{5}{16}$ " DIAMETER		8 PCS
D	WRENCH/ CLÉ/ LLAVE INGLESA $\frac{1}{2}$ "		1 PC
E	FLAT WASHER/ RONDELLE PLATE/ ARANDELA PLANA $\frac{5}{16}$ " DIAMETER x $\frac{3}{4}$ " x $\frac{1}{16}$ "		10 PCS
F	LOCK WASHER/ RONDELLE DE BLOCAGE/ ARANDELA DE BLOQUEO $\frac{5}{16}$ " DIAMETER x $\frac{1}{2}$ " x $\frac{1}{16}$ "		10 PCS
G	BOLT/ BOULON/ TORNILLO $\frac{5}{16}$ " DIAMETER x 1 $\frac{3}{4}$ " LENGTH		10 PCS
H	ALLEN KEY/ CLÉ ALLEN/ LLAVE INGLESA ALLEN $\frac{3}{16}$ "		1 PC
I	SCREW/ VIS/ TORNILLO M4 x 1 $\frac{1}{4}$ " LENGTH		29 PCS

### LIST OF PARTS AND HARDWARE/ LISTE DES PIÈCES ET DU MATÉRIEL/ LISTA DE PIEZAS Y HARDWARE

NO#/ NOMBRE/ NÚMERO	DESCRIPTION/ DESCRIPTION/ DESCRIPCIÓN		QUANTITY/ QUANTITÉ/ CANTIDAD
1	HEADBOARD/ TÊTE DE LIT/ CABECERA		1 PC
2	KD LEFT HEADBOARD LEG/ JAMBE GAUCHE DE TÊTE DE LIT KD/ PATA IZQUIERDA KD PARA CABEZERA		1 PC
3	KD RIGHT HEADBOARD LEG/ JAMBE DROITE DE TÊTE DE LIT KD/ PATA DERECHA KD PARA CABEZERA		1 PC
4	WOOD MENDING PLATE/ PLAQUE DE RÉPARATION/ PLACA DE REPARACIÓN		2 PCS
5	BOTTOM RAIL/ RAIL INFÉRIEUR/ RIEL INFERIOR		1 PC
6	FOOTBOARD/ PIED DE LIT/ ESTRIBO		1 PC
7	SIDE RAIL / RAIL LATÉRAL / CARRIL LATERAL		2 PCS
8	SLAT ROLL/ ROULEAU DE LATTES/ ROLLO DE LISTONES		13 PCS
9	BOTTOM SLAT "A"/ LATTE INFÉRIEURE "A"/ LISTÓN INFERIOR "A"		2 PCS
10	BOTTOM SLAT "B"/ LATTE INFÉRIEURE "B"/ LISTÓN INFERIOR "B"		2 PCS
11	SLAT SUPPORT LEG/ JAMBE D'APPUI/ PIERNA DE APOYO		6 PCS

NOTE:  
SPIRIT LEVELER NOT INCLUDED BUT NEEDED TO EVEN THE FLOOR.  
SPIRIT LEVELER NON INCLUS MAIS NÉCESSAIRE MÊME LE SOL.  
NIVELADOR DE ESPÍRITU NO INCLUIDO PERO ES NECESARIO PARA INCLUSO EL PISO.

# ASSEMBLY INSTRUCTIONS INSTRUCTIONS DE MONTAGE INSTRUCCIONES DE MONTAJE

## KING PANEL BED WITH METAL HEADBOARD

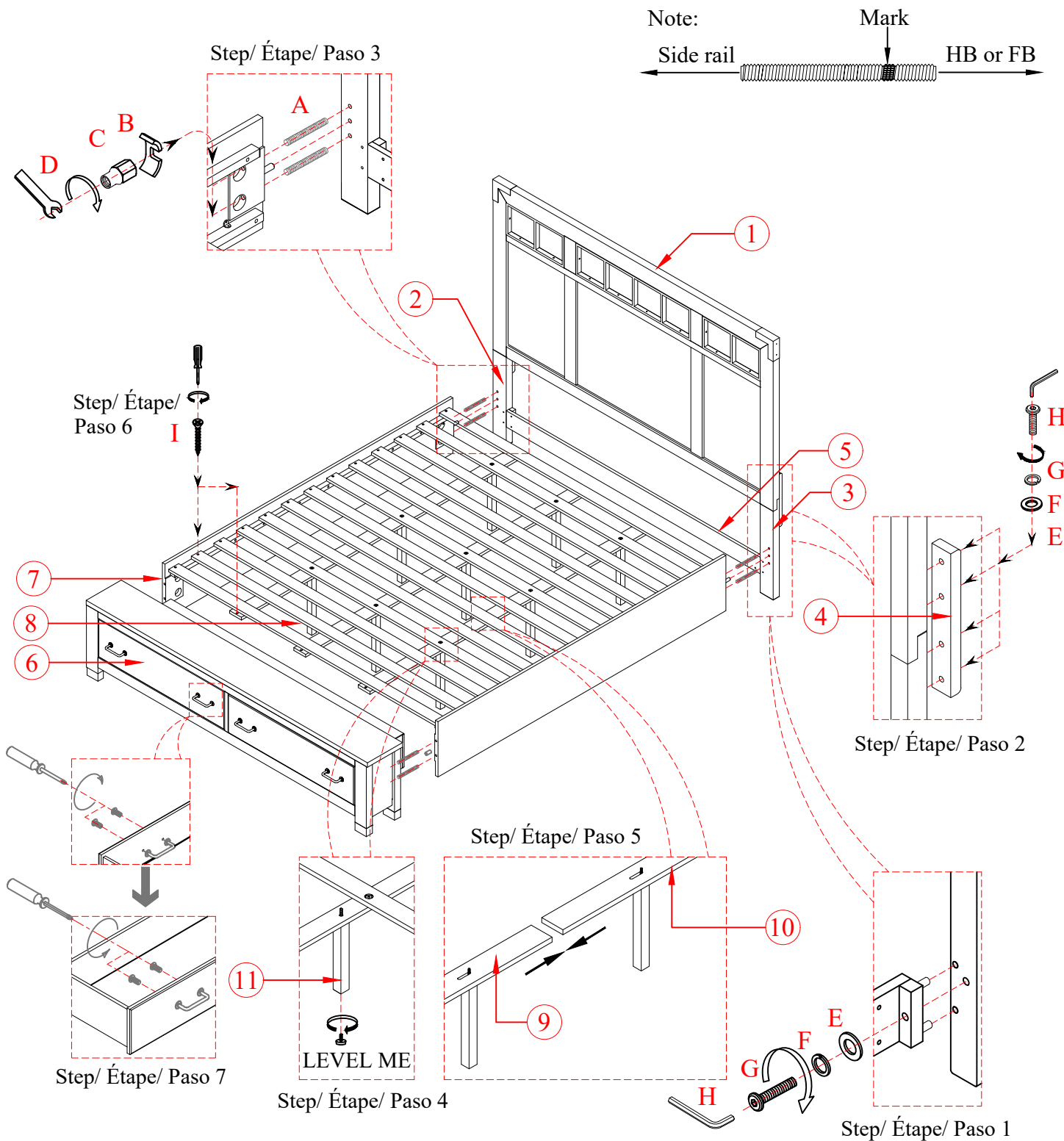

NOTE:  
SPIRIT LEVELER NOT INCLUDED BUT NEEDED TO EVEN THE FLOOR.  
SPIRIT LEVELER NON INCLUS MAIS NÉCESSAIRE MÊME LE SOL.  
NIVELADOR DE ESPÍRITU NO INCLUIDO PERO ES NECESARIO PARA INCLUSO EL PISO.

# ASSEMBLY INSTRUCTIONS INSTRUCTIONS DE MONTAGE INSTRUCCIONES DE MONTAJE

## CAL KING PANEL BED

**CAUTION:** PLEASE READ ALL INSTRUCTIONS BEFORE STARTING THE ASSEMBLY OF THIS PRODUCT. THESE PIECES ARE HEAVY. IN ORDER TO PREVENT PERSONAL INJURY AND ENSURE THAT THIS PRODUCT IS NOT DAMAGED DURING THE ASSEMBLY PROCESS, IT IS STRONGLY RECOMMENDED TO ENLIST THE ASSISTANCE OF ONE OR MORE PERSONS. IN CASE OF EXCESS STAIN, WIPE THE BOTTOM OF THE UNIT BEFORE PLACING ON ANY SURFACE.

**ATTENTION:** VEUILLEZ LIRE TOUTES LES INSTRUCTIONS AVANT DE COMMENCER L'ASSEMBLAGE DE CE PRODUIT. LES PIECES SONT LOURDES. POUR EVITER TOUTE BLESSURE ET POUR VOUS ASSURER QUE LE PRODUIT N'EST PAS ENDOMMAGE' PENDANT L'ASSEMBLAGE, NOUS VOUS RECOMMANDONS DE FAIRE APPEL A UNE OU PLUSIEURS AUTRES PERSONNES. EN CAS DE TACHE EXCESSIVE, ESSUYEZ LE FOND DE L'UNITE' AVANT LE PLACEMENT SUR N'IMPORTE QUELLE SURFACE.

**CUIDADO:** FAVOR DE LEER TODAS LAS INSTRUCCIONES ANTES DE ENSAMBLAR SU PRODUCTO, ESTAS PIEZAS SON PESADAS. PARA PREVENIR HERIDAS PERSONALES Y ASEGURAR QUE SU PRODUCTO NO SEA DANADO MIENTRAS ES ENSAMBLADO. SE RECOMIENDA LA ASISTENCIA DE UNA O MAS PERSONAS.

**WARNING:** PROTECTIVE GLIDE IS PLACED UNDER EACH LEG OF THE FURNITURE TO RESIST SCRATCHES ON FLOOR SURFACE. SOME FLOOR SURFACES CAN BE EXTRA SENSITIVE TO SCRATCHES AND MARKINGS, IF YOU ARE NOT SURE CONSULT WITH YOUR DEALER.  
AVERTISSEMENT. LES PIEDS DES MEUBLES SONT MUNIS DE PATINS DESTINES A PROTEGER LE PLANCHER. CERTAINS REVETEMENTS DE SOL PEUVENT ETRE TRES FRAGILES. EN CAS DE DOUTE. CONSULTER LE MARCHAND.

**NOTE:**

MUST USE 3 Watts, 12 Volt DC Bulb with E26/E27 SOCKET.  
DOIT UTILISER UNE AMPOULE DE 3 WATTS, 12 VOLTS DC AVEC PRISE E26 / E27.  
DEBE USAR 3 WATTS, BOMBILLA DE 12 VOLTIOS DC CON ENCHUFE E26 / E27.

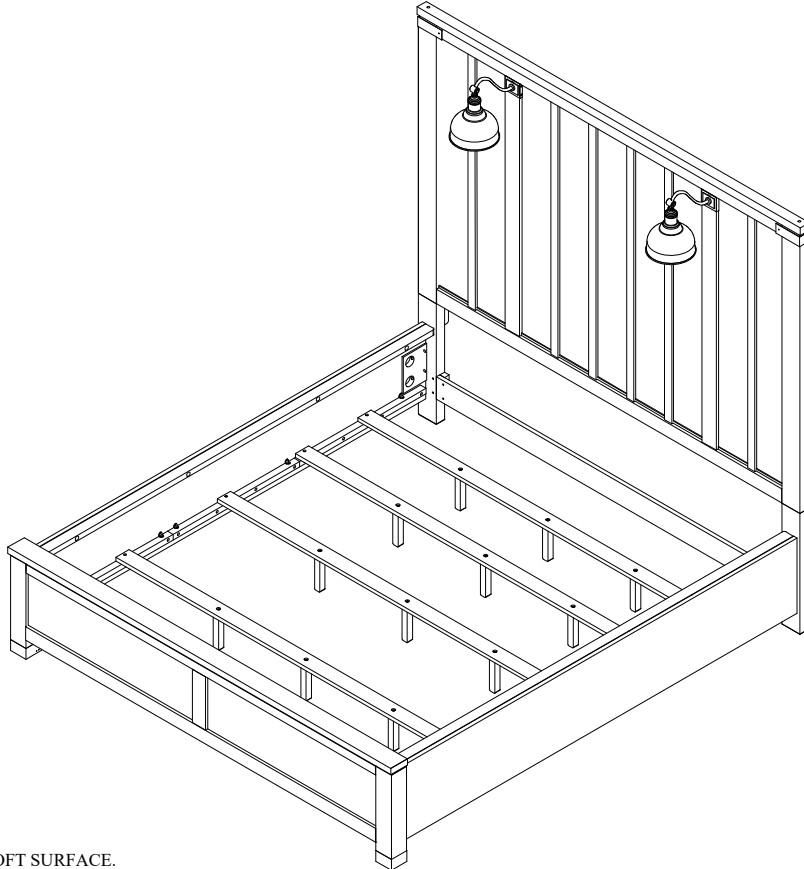













**NOTE:**  
ASSEMBLE UNIT ON A SOFT SURFACE.  
ASSEMBLEZ L'UNITE' SUR UNE SURFACE MOLLE.  
ENSAMBLE LA UNIDAD EN UNA SUPERFICIE PLANA Y SUAVE.

DO NOT TIGHTEN BOLTS UNTIL ALL PARTS AND HARDWARE OF THE UNIT ARE ASSEMBLED.  
NE SERREZ PAS LES BOULONS JUSQU'À CE QUE L'UNITE' SOIT COMPLÈTEMENT ASSEMBLÉE.  
NO APRIETE LOS TORNILLOS HASTA QUE LA UNIDAD ESTE COMPLETAMENTE ENSAMBLADA.













# ASSEMBLY INSTRUCTIONS INSTRUCTIONS DE MONTAGE INSTRUCCIONES DE MONTAJE

## CAL KING PANEL BED

### LIST OF PARTS AND HARDWARE/ LISTE DES PIÈCES ET DU MATÉRIEL/ LISTA DE PIEZAS Y HARDWARE

NO#/ NOMBRE/ NÚMERO	DESCRIPTION/ DESCRIPTION/ DESCRIPCIÓN		QUANTITY/ QUANTITÉ/ CANTIDAD
A	BOLT/ BOULON/ TORNILLO $\frac{5}{16}$ " DIAMETER x 4 $\frac{1}{2}$ " LENGTH		8 PCS
B	LOCK WASHER "C"/ RONDELLE DE BLOCAGE "C"/ ARANDELA DE BLOQUEO "C" $\frac{5}{16}$ " DIAMETER		8 PCS
C	NUT/ ÉCROU/ NUEZ $\frac{5}{16}$ " DIAMETER		8 PCS
D	WRENCH/ CLÉ/ LLAVE INGLESA $\frac{1}{2}$ "		1 PC
E	FLAT WASHER/ RONDELLE PLATE/ ARANDELA PLANA $\frac{5}{16}$ " DIAMETER x $\frac{3}{4}$ " x $\frac{1}{16}$ "		10 PCS
F	LOCK WASHER/ RONDELLE DE BLOCAGE/ ARANDELA DE BLOQUEO $\frac{5}{16}$ " DIAMETER x $\frac{1}{2}$ " x $\frac{1}{16}$ "		10 PCS
G	BOLT/ BOULON/ TORNILLO $\frac{5}{16}$ " DIAMETER x 1 $\frac{3}{4}$ " LENGTH		10 PCS
H	ALLEN KEY/ CLÉ ALLEN/ LLAVE INGLESA ALLEN $\frac{3}{16}$ "		1 PC
I	SCREW/ VIS/ TORNILLO M4 x 1 $\frac{1}{4}$ " LENGTH		16 PCS
J	BOLT/ BOULON/ TORNILLO $\frac{1}{4}$ " DIAMETER x 2" LENGTH		10 PCS
K	FLAT WASHER/ RONDELLE PLATE/ ARANDELA PLANA $\frac{1}{4}$ " DIAMETER x $\frac{3}{4}$ " x $\frac{1}{16}$ "		10 PCS
L	LOCK WASHER/ RONDELLE DE BLOCAGE/ ARANDELA DE BLOQUEO $\frac{1}{4}$ " DIAMETER x $\frac{1}{2}$ " x $\frac{1}{16}$ "		10 PCS

### LIST OF PARTS AND HARDWARE/ LISTE DES PIÈCES ET DU MATÉRIEL/ LISTA DE PIEZAS Y HARDWARE

NO#/ NOMBRE/ NÚMERO	DESCRIPTION/ DESCRIPTION/ DESCRIPCIÓN		QUANTITY/ QUANTITÉ/ CANTIDAD
1	HEADBOARD/ TÊTE DE LIT/ CABECERA		1 PC
2	KD LEFT HEADBOARD LEG/ JAMBE GAUCHE DE TÊTE DE LIT KD/ PATA IZQUIERDA KD PARA CABEZERA		1 PC
3	KD RIGHT HEADBOARD LEG/ JAMBE DROITE DE TÊTE DE LIT KD/ PATA DERECHA KD PARA CABEZERA		1 PC
4	WOOD MENDING PLATE/ PLAQUE DE RÉPARATION/ PLACA DE REPARACIÓN		2 PCS
5	BOTTOM RAIL/ RAIL INFÉRIEUR/ RIEL INFERIOR		1 PC
6	FOOTBOARD/ PIED DE LIT/ ESTRIBO		1 PC
7	SIDE RAIL / RAIL LATÉRAL / CARRIL LATERAL		2 PCS
8	SLAT/ LATTE/ LISTÓN		4 PCS
9	SLAT SUPPORT LEG/ JAMBE D'APPUI/ PIERNA DE APOYO		12 PCS
10	SIDE RAIL CLEAT/ PINCE DE RAIL LATÉRAL/ CALA LATERAL DEL CARRIL		2 PCS
11	BULB HOLDER/ PORTE-AMPOULE/ PORTALÁMPARAS		2 PCS
12	LAMP SHADE/ FORME DE LA LAMPE/ PANTALLA DE LÁMPARA		2 PCS
13	(OUTPUT: 12V-MAX DC Bulb:3W with E26/E27 SOCKET) LIGHT BULB/ AMPOULE/ BOMBILLA (NOT PROVIDED)		2 PCS

NOTE:  
SPIRIT LEVELER NOT INCLUDED BUT NEEDED TO EVEN THE FLOOR.  
SPIRIT LEVELER NON INCLUS MAIS NÉCESSAIRE MÊME LE SOL.  
NIVELADOR DE ESPÍRITU NO INCLUIDO PERO ES NECESARIO PARA INCLUSO EL PISO.

# ASSEMBLY INSTRUCTIONS INSTRUCTIONS DE MONTAGE INSTRUCCIONES DE MONTAJE

## CAL KING PANEL BED

Note: Side rail      Mark      HB or FB

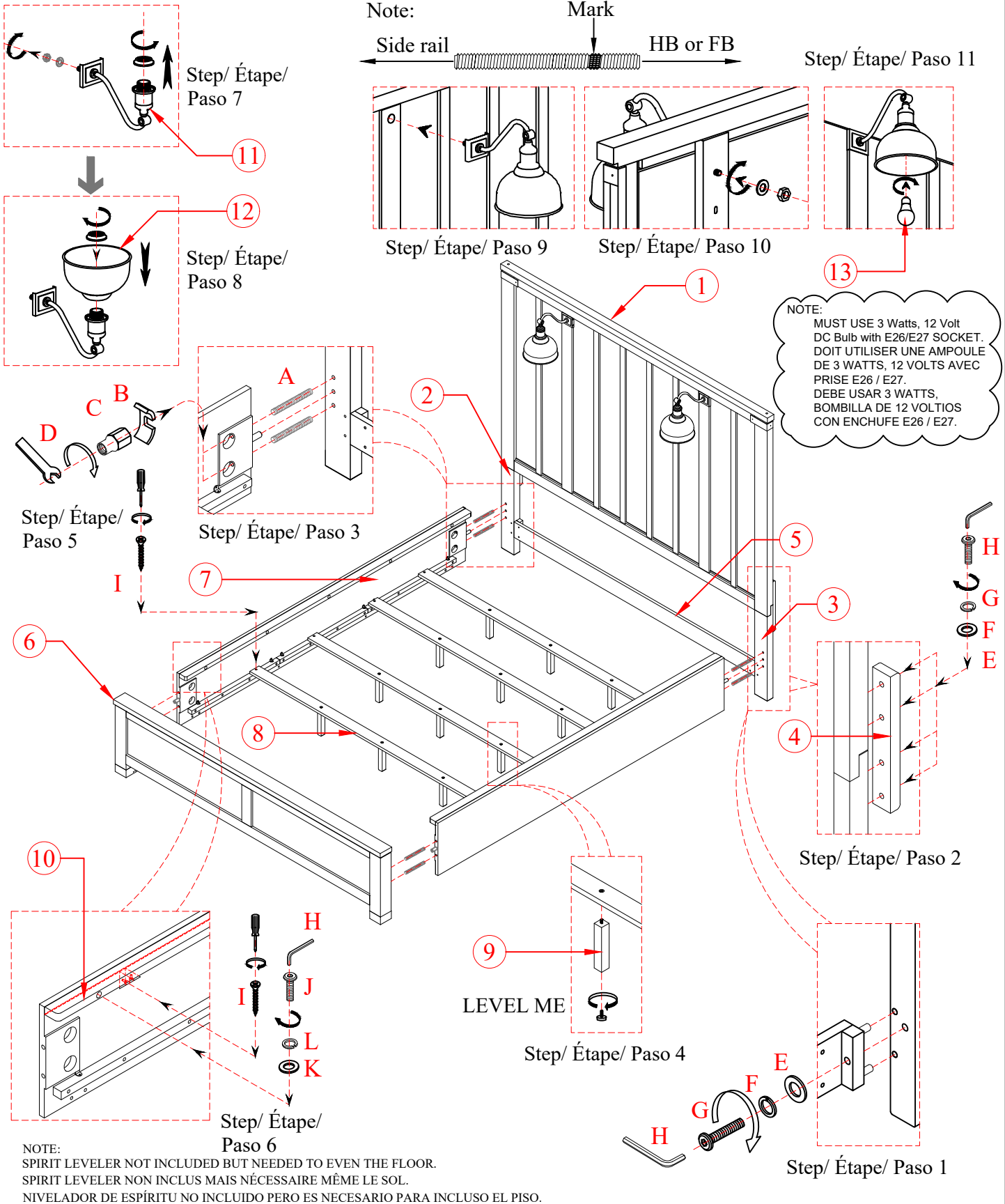

# ASSEMBLY INSTRUCTIONS INSTRUCTIONS DE MONTAGE INSTRUCCIONES DE MONTAJE

## CAL KING PANEL BED

### WIRING DIAGRAM

Step/ Étape/ Paso 11

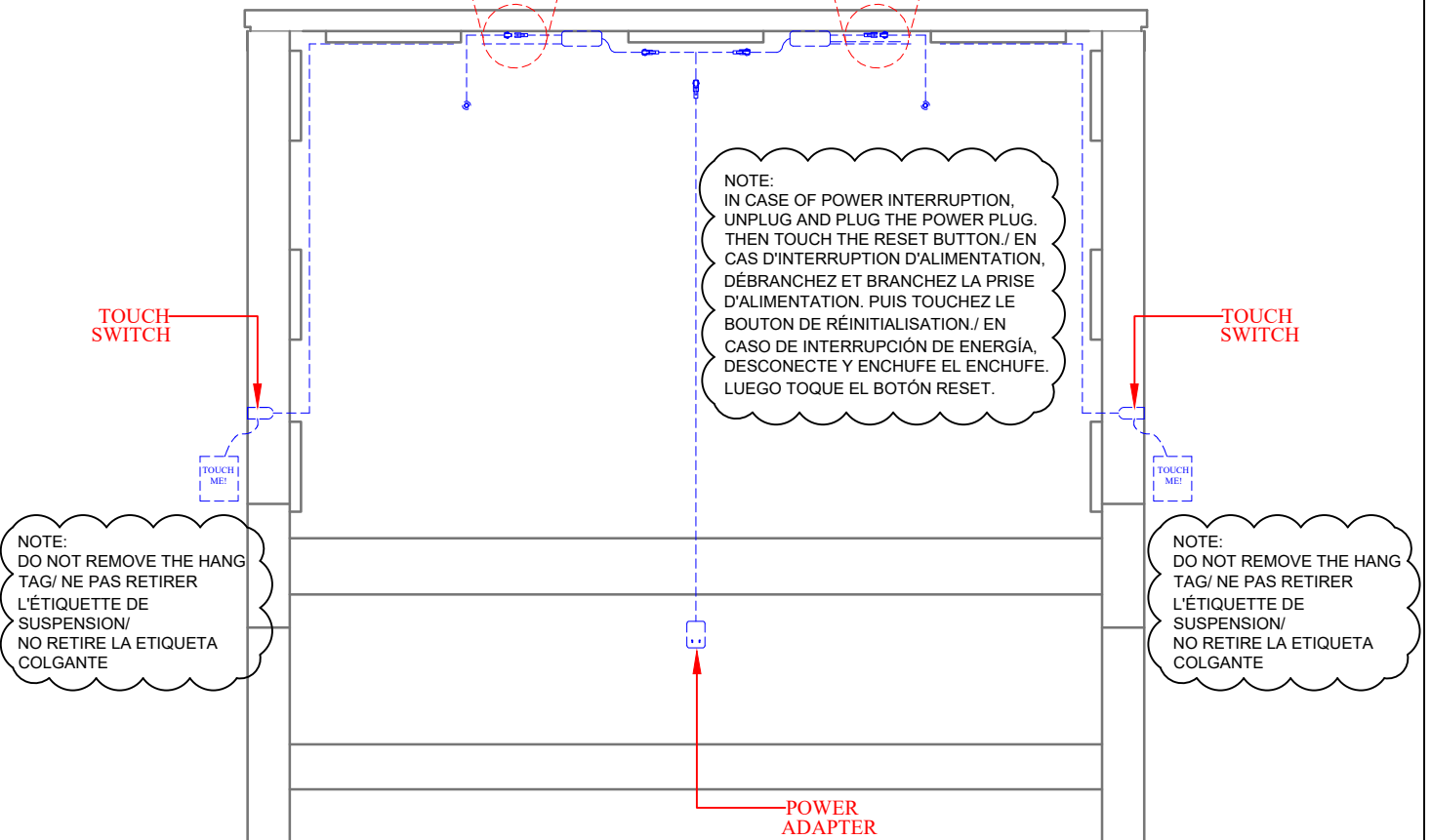
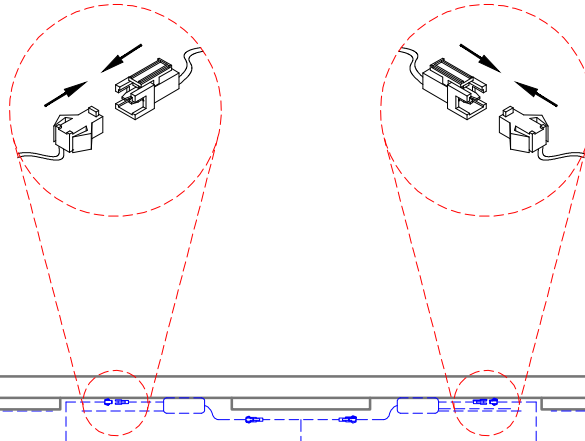

NOTE:  
SPIRIT LEVELER NOT INCLUDED BUT NEEDED TO EVEN THE FLOOR.  
SPIRIT LEVELER NON INCLUS MAIS NÉCESSAIRE MÊME LE SOL.  
NIVELADOR DE ESPÍRITU NO INCLUIDO PERO ES NECESARIO PARA INCLUSO EL PISO.

# ASSEMBLY INSTRUCTIONS INSTRUCTIONS DE MONTAGE INSTRUCCIONES DE MONTAJE

## CAL KING PANEL BED

**CAUTION:** PLEASE READ ALL INSTRUCTIONS BEFORE STARTING THE ASSEMBLY OF THIS PRODUCT. THESE PIECES ARE HEAVY. IN ORDER TO PREVENT PERSONAL INJURY AND ENSURE THAT THIS PRODUCT IS NOT DAMAGED DURING THE ASSEMBLY PROCESS, IT IS STRONGLY RECOMMENDED TO ENLIST THE ASSISTANCE OF ONE OR MORE PERSONS. IN CASE OF EXCESS STAIN, WIPE THE BOTTOM OF THE UNIT BEFORE PLACING ON ANY SURFACE.

**ATTENTION:** VEUILLEZ LIRE TOUTES LES INSTRUCTIONS AVANT DE COMMENCER L'ASSEMBLAGE DE CE PRODUIT. LES PIECES SONT LOURDES. POUR EVITER TOUTE BLESSURE ET POUR VOUS ASSURER QUE LE PRODUIT N'EST PAS ENDOMMAGE' PENDANT L'ASSEMBLAGE, NOUS VOUS RECOMMANDONS DE FAIRE APPEL A UNE OU PLUSIEURS AUTRES PERSONNES. EN CAS DE TACHE EXCESSIVE, ESSUYEZ LE FOND DE L'UNITE' AVANT LE PLACEMENT SUR N'IMPORTE QUELLE SURFACE.

**CUIDADO:** FAVOR DE LEER TODAS LAS INSTRUCCIONES ANTES DE ENSAMBLAR SU PRODUCTO, ESTAS PIEZAS SON PESADAS. PARA PREVENIR HERIDAS PERSONALES Y ASEGURAR QUE SU PRODUCTO NO SEA DANADO MIENTRAS ES ENSAMBLADO. SE RECOMIENDA LA ASISTENCIA DE UNA O MAUS PERSONAS.

**WARNING:** PROTECTIVE GLIDE IS PLACED UNDER EACH LEG OF THE FURNITURE TO RESIST SCRATCHES ON FLOOR SURFACE. SOME FLOOR SURFACES CAN BE EXTRA SENSITIVE TO SCRATCHES AND MARKINGS, IF YOU ARE NOT SURE CONSULT WITH YOUR DEALER. AVERTISSEMENT. LES PIEDS DES MEUBLES SONT MUNIS DE PATINS DESTINES A PROTEGER LE PLANCHER. CERTAINS REVETEMENTS DE SOL PEUVENT ETRE TRES FRAGILES. EN CAS DE DOUTE. CONSULTER LE MARCHAND.

**NOTE:**

MUST USE 3 Watts, 12 Volt DC Bulb with E26/E27 SOCKET.  
DOIT UTILISER UNE AMPOULE DE 3 WATTS, 12 VOLTS DC AVEC PRISE E26 / E27.  
DEBE USAR 3 WATTS, BOMBILLA DE 12 VOLTIOS DC CON ENCHUFE E26 / E27.

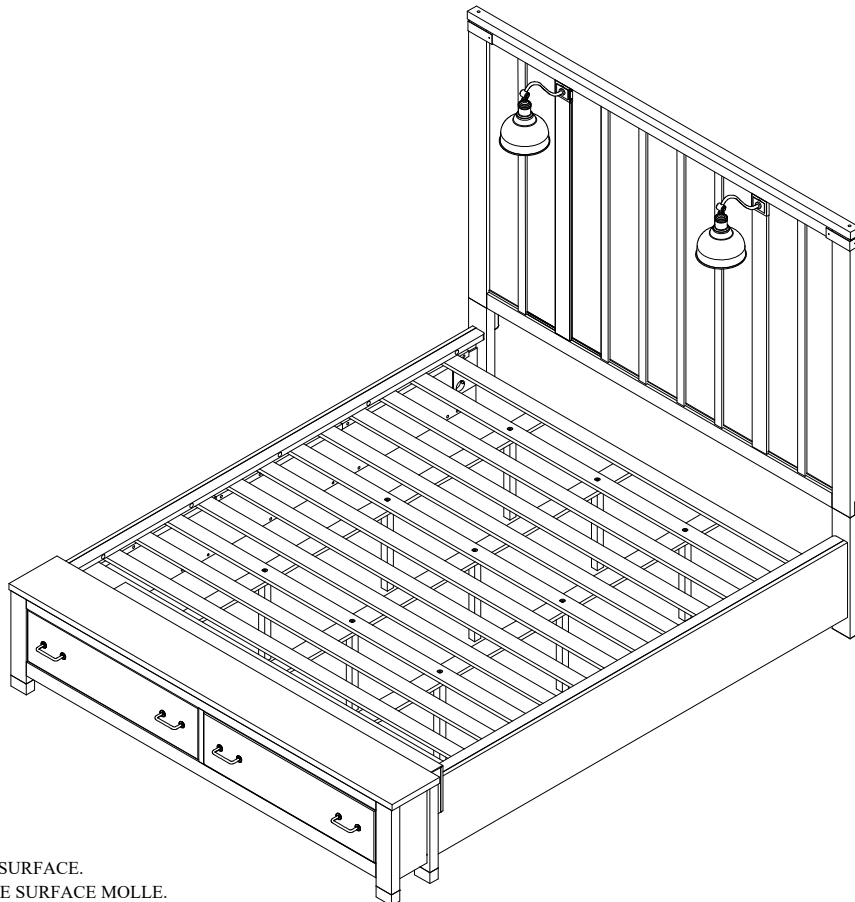













**NOTE:**  
ASSEMBLE UNIT ON A SOFT SURFACE.  
ASSEMBLEZ L'UNITE' SUR UNE SURFACE MOLLE.  
ENSAMBLE LA UNIDAD EN UNA SUPERFICIE PLANA Y SUAVE.

DO NOT TIGHTEN BOLTS UNTIL ALL PARTS AND HARDWARE OF THE UNIT ARE ASSEMBLED.  
NE SERREZ PAS LES BOULONS JUSQU'À CE QUE L'UNITE' SOIT COMPLÈTEMENT ASSEMBLÉE.  
NO APRIETE LOS TORNILLOS HASTA QUE LA UNIDAD ESTE COMPLETAMENTE ENSAMBLADA.















# ASSEMBLY INSTRUCTIONS INSTRUCTIONS DE MONTAGE INSTRUCCIONES DE MONTAJE

## CAL KING PANEL BED

### LIST OF PARTS AND HARDWARE/ LISTE DES PIÈCES ET DU MATÉRIEL/ LISTA DE PIEZAS Y HARDWARE

NO#/ NOMBRE/ NÚMERO	DESCRIPTION/ DESCRIPTION/ DESCRIPCIÓN		QUANTITY/ QUANTITÉ/ CANTIDAD
A	BOLT/ BOULON/ TORNILLO $\frac{5}{16}$ " DIAMETER x 4 $\frac{1}{2}$ " LENGTH		8 PCS
B	LOCK WASHER "C"/ RONDELLE DE BLOCAGE "C"/ ARANDELA DE BLOQUEO "C" $\frac{5}{16}$ " DIAMETER		8 PCS
C	NUT/ ÉCROU/ NUEZ $\frac{5}{16}$ " DIAMETER		8 PCS
D	WRENCH/ CLÉ/ LLAVE INGLESA $\frac{1}{2}$ "		1 PC
E	FLAT WASHER/ RONDELLE PLATE/ ARANDELA PLANA $\frac{5}{16}$ " DIAMETER x $\frac{3}{4}$ " x $\frac{1}{16}$ "		12 PCS
F	LOCK WASHER/ RONDELLE DE BLOCAGE/ ARANDELA DE BLOQUEO $\frac{5}{16}$ " DIAMETER x $\frac{1}{2}$ " x $\frac{1}{16}$ "		12 PCS
G	BOLT/ BOULON/ TORNILLO $\frac{5}{16}$ " DIAMETER x 1 $\frac{3}{4}$ " LENGTH		12 PCS
H	ALLEN KEY/ CLÉ ALLEN/ LLAVE INGLESA ALLEN $\frac{3}{16}$ "		1 PC
I	SCREW/ VIS/ TORNILLO M4 x 1 $\frac{1}{4}$ " LENGTH		29 PCS
J	BOLT/ BOULON/ TORNILLO $\frac{1}{4}$ " DIAMETER x 2" LENGTH		10 PCS
K	FLAT WASHER/ RONDELLE PLATE/ ARANDELA PLANA $\frac{1}{4}$ " DIAMETER x $\frac{3}{4}$ " x $\frac{1}{16}$ "		10 PCS
L	LOCK WASHER/ RONDELLE DE BLOCAGE/ ARANDELA DE BLOQUEO $\frac{1}{4}$ " DIAMETER x $\frac{1}{2}$ " x $\frac{1}{16}$ "		10 PCS

### LIST OF PARTS AND HARDWARE/ LISTE DES PIÈCES ET DU MATÉRIEL/ LISTA DE PIEZAS Y HARDWARE

NO#/ NOMBRE/ NÚMERO	DESCRIPTION/ DESCRIPTION/ DESCRIPCIÓN		QUANTITY/ QUANTITÉ/ CANTIDAD
1	HEADBOARD/ TÊTE DE LIT/ CABECERA		1 PC
2	KD LEFT HEADBOARD LEG/ JAMBE GAUCHE DE TÊTE DE LIT KD/ PATA IZQUIERDA KD PARA CABEZERA		1 PC
3	KD RIGHT HEADBOARD LEG/ JAMBE DROITE DE TÊTE DE LIT KD/ PATA DERECHA KD PARA CABEZERA		1 PC
4	WOOD MENDING PLATE/ PLAQUE DE RÉPARATION/ PLACA DE REPARACIÓN		2 PCS
5	BOTTOM RAIL/ RAIL INFÉRIEUR/ RIEL INFERIOR		1 PC
6	FOOTBOARD/ PIED DE LIT/ ESTRIBO		1 PC
7	SIDE RAIL / RAIL LATÉRAL / CARRIL LATERAL		2 PCS
8	SLAT ROLL/ ROULEAU DE LATTES/ ROLLO DE LISTONES		13 PCS
9	BOTTOM SLAT "A"/ LATTE INFÉRIEURE "A"/ LISTÓN INFERIOR "A"		2 PCS
10	BOTTOM SLAT "B"/ LATTE INFÉRIEURE "B"/ LISTÓN INFERIOR "B"		2 PCS
11	SLAT SUPPORT LEG/ JAMBE D'APPUI/ PIERNA DE APOYO		6 PCS
12	SIDE RAIL CLEAT/ PINCE DE RAIL LATÉRAL/ CALA LATERAL DEL CARRIL		2 PCS
13	BULB HOLDER/ PORTE-AMPOULE/ PORTALÁMPARAS		2 PCS
14	LAMP SHADE/ FORME DE LA LAMPE/ PANTALLA DE LÁMPARA		2 PCS
15	(OUTPUT: 12V-MAX DC Bulb:3W with E26/E27 SOCKET) LIGHT BULB/ AMPOULE/ BOMBILLA (NOT PROVIDED)		2 PCS

NOTE:  
SPIRIT LEVELER NOT INCLUDED BUT NEEDED TO EVEN THE FLOOR.  
SPIRIT LEVELER NON INCLUS MAIS NÉCESSAIRE MÊME LE SOL.  
NIVELADOR DE ESPÍRITU NO INCLUIDO PERO ES NECESARIO PARA INCLUSO EL PISO.

# ASSEMBLY INSTRUCTIONS INSTRUCTIONS DE MONTAGE INSTRUCCIONES DE MONTAJE

## CAL KING PANEL BED

Note: Mark  
Side rail HB or FB

Step/ Étape/ Paso 12

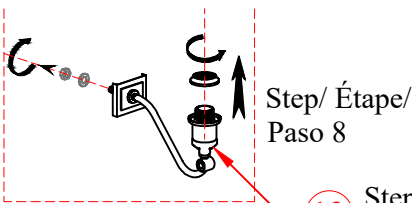

13 Step/ Étape/ Paso 10

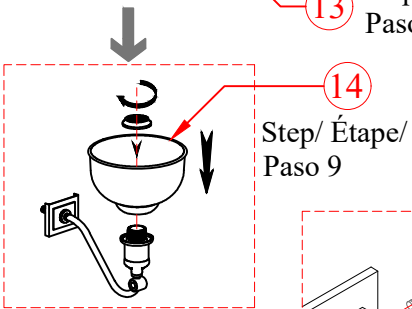
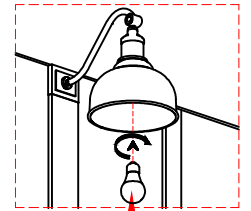
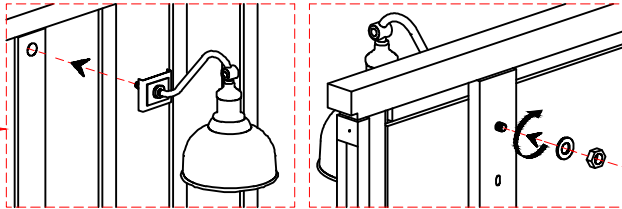

NOTE:  
MUST USE 3 Watts, 12 Volt DC Bulb with E26/E27 SOCKET.  
DOIT UTILISER UNE AMPOULE DE 3 WATTS, 12 VOLTS AVEC PRISE E26 / E27.  
DEBE USAR 3 WATTS, BOMBILLA DE 12 VOLTIOS CON ENCHUFE E26 / E27.

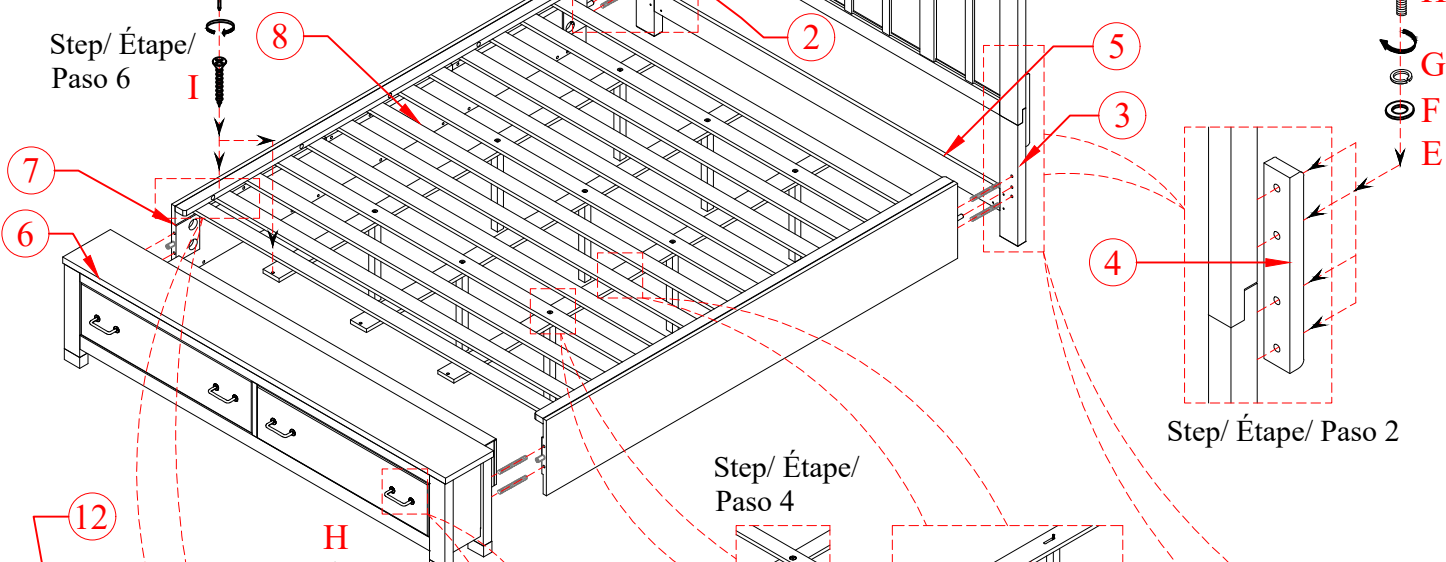
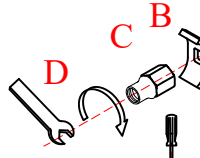
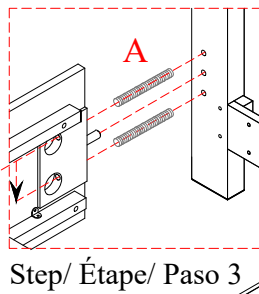

Step/ Étape/ Paso 2

Step/ Étape/ Paso 4

11 LEVEL ME

9 Step/ Étape/ Paso 5

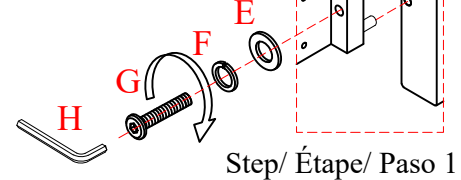
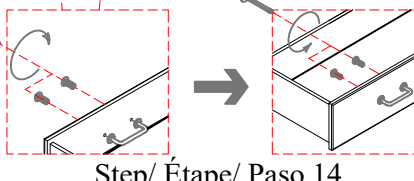
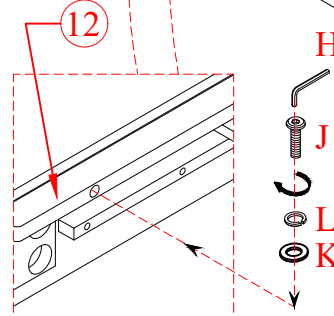

NOTE:  
SPIRIT LEVELER NOT INCLUDED BUT NEEDED TO EVEN THE FLOOR.  
SPIRIT LEVELER NON INCLUS MAIS NÉCESSAIRE MÊME LE SOL.  
NIVELADOR DE ESPÍRITU NO INCLUIDO PERO ES NECESARIO PARA INCLUSO EL PISO.

# ASSEMBLY INSTRUCTIONS INSTRUCTIONS DE MONTAGE INSTRUCCIONES DE MONTAJE

## CAL KING PANEL BED

### WIRING DIAGRAM

Step/ Étape/ Paso 11

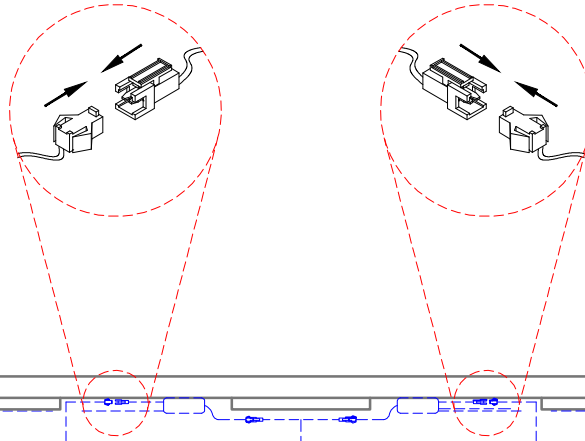

NOTE:  
IN CASE OF POWER INTERRUPTION,  
UNPLUG AND PLUG THE POWER PLUG.  
THEN TOUCH THE RESET BUTTON./ EN  
CAS D'INTERRUPTION D'ALIMENTATION,  
DÉBRANCHEZ ET BRANCHEZ LA PRISE  
D'ALIMENTATION. PUIS TOUCHEZ LE  
BOUTON DE RÉINITIALISATION./ EN  
CASO DE INTERRUPCIÓN DE ENERGÍA,  
DESCONECTE Y ENCHUFE EL ENCHUFE.  
LUEGO TOQUE EL BOTÓN RESET.

NOTE:  
DO NOT REMOVE THE HANG  
TAG/ NE PAS RETIRER  
L'ÉTIQUETTE DE  
SUSPENSION/  
NO RETIRE LA ETIQUETA  
COLGANTE

NOTE:  
DO NOT REMOVE THE HANG  
TAG/ NE PAS RETIRER  
L'ÉTIQUETTE DE  
SUSPENSION/  
NO RETIRE LA ETIQUETA  
COLGANTE

NOTE:  
SPIRIT LEVELER NOT INCLUDED BUT NEEDED TO EVEN THE FLOOR.  
SPIRIT LEVELER NON INCLUS MAIS NÉCESSAIRE MÊME LE SOL.  
NIVELADOR DE ESPÍRITU NO INCLUIDO PERO ES NECESARIO PARA INCLUSO EL PISO.

# ASSEMBLY INSTRUCTIONS INSTRUCTIONS DE MONTAGE INSTRUCCIONES DE MONTAJE

## CAL KING PANEL BED WITH METAL HEADBOARD

**CAUTION:** PLEASE READ ALL INSTRUCTIONS BEFORE STARTING THE ASSEMBLY OF THIS PRODUCT. THESE PIECES ARE HEAVY. IN ORDER TO PREVENT PERSONAL INJURY AND ENSURE THAT THIS PRODUCT IS NOT DAMAGED DURING THE ASSEMBLY PROCESS, IT IS STRONGLY RECOMMENDED TO ENLIST THE ASSISTANCE OF ONE OR MORE PERSONS. IN CASE OF EXCESS STAIN, WIPE THE BOTTOM OF THE UNIT BEFORE PLACING ON ANY SURFACE.

**ATTENTION:** VEUILLEZ LIRE TOUTES LES INSTRUCTIONS AVANT DE COMMENCER L'ASSEMBLAGE DE CE PRODUIT. LES PIECES SONT LOURDES. POUR EVITER TOUTE BLESSURE ET POUR VOUS. ASSURER QUE LE PRODUIT N'EST PAS ENDOMMAGE' PENDANT L'ASSEMBLAGE, NOUS VOUS RECOMMANDONS DE FAIRE APPEL A UNE OU PLUSIEURS AUTRES PERSONNES. EN CAS DE TACHE EXCESSIVE, ESSUYEZ LE FOND DE L'UNITE' AVANT LE PLACEMENT SUR N'IMPORTE QUELLE SURFACE.

**CUIDADO:** FAVOR DE LEER TODAS LAS INSTRUCCIONES ANTES DE ENSAMBLAR SU PRODUCTO, ESTAS. PIEZAS SON PESADAS. PARA PREVENIR HERIDAS PERSONALES Y ASEGURAR QUE SU PRODUCTO NO SEA DAN ADO MIENTRAS ES ENSAMBLADO. SE RECOMIENDA LA ASISTENCIA DE UNA O MAUS PERSONAS.

**WARNING:** PROTECTIVE GLIDE IS PLACED UNDER EACH LEG OF THE FURNITURE TO RESIST SCRATCHES ON FLOOR SURFACE. SOME FLOOR SURFACES CAN BE EXTRA SENSITIVE TO SCRATCHES AND MARKINGS, IF YOU ARE NOT SURE CONSULT WITH YOUR DEALER.  
AVERTISSEMENT. LES PIEDS DES MEUBLES SONT MUNIS DE PATINS DESTINES A PROTEGER LE PLANCHER. CERTAINS REVETEMENTS DE SOL PEUVENT ETRE TRES FRAGILES. EN CAS DE DOUTE. CONSULTER LE MARCHAND.

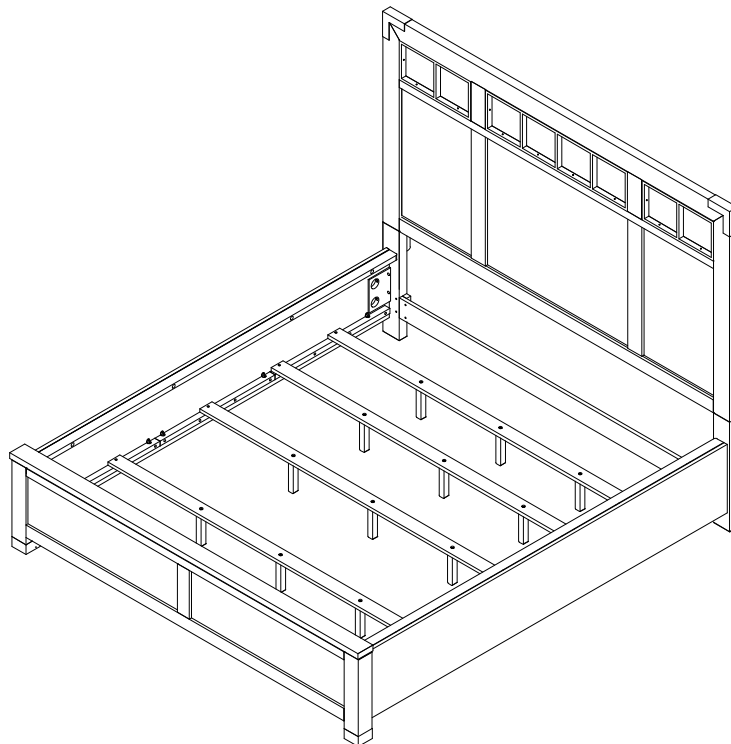













NOTE:  
ASSEMBLE UNIT ON A SOFT SURFACE.  
ASSEMBLEZ L'UNITÉ SUR UNE SURFACE MOLLE.  
ENSAMBLE LA UNIDAD EN UNA SUPERFICIE PLANA Y SUAVE.

DO NOT TIGHTEN BOLTS UNTIL **ALL PARTS AND HARDWARE OF** THE UNIT ARE ASSEMBLED.  
NE SERREZ PAS LES BOULONS JUSQU'À CE QUE L'UNITÉ SOIT COMPLÈTEMENT ASSEMBLÉE.  
NO APRIETE LOS TORNILLOS HASTA QUE LA UNIDAD ESTE COMPLETAMENTE ENSAMBLADA.









# ASSEMBLY INSTRUCTIONS INSTRUCTIONS DE MONTAGE INSTRUCCIONES DE MONTAJE

## CAL KING PANEL BED WITH METAL HEADBOARD

### LIST OF PARTS AND HARDWARE/ LISTE DES PIÈCES ET DU MATÉRIEL/ LISTA DE PIEZAS Y HARDWARE

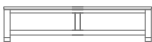
NO#/ NOMBRE/ NÚMERO	DESCRIPTION/ DESCRIPTION/ DESCRIPCIÓN		QUANTITY/ QUANTITÉ/ CANTIDAD
A	BOLT/ BOULON/ TORNILLO $\frac{5}{16}$ " DIAMETER x $4\frac{1}{2}$ " LENGTH		8 PCS
B	LOCK WASHER "C"/ RONDELLE DE BLOCAGE "C"/ ARANDELA DE BLOQUEO "C" $\frac{5}{16}$ " DIAMETER		8 PCS
C	NUT/ ÉCROU/ NUEZ $\frac{5}{16}$ " DIAMETER		8 PCS
D	WRENCH/ CLÉ/ LLAVE INGLESA $\frac{1}{2}$ "		1 PC
E	FLAT WASHER/ RONDELLE PLATE/ ARANDELA PLANA $\frac{5}{16}$ " DIAMETER x $\frac{3}{4}$ " x $\frac{1}{16}$ "		10 PCS
F	LOCK WASHER/ RONDELLE DE BLOCAGE/ ARANDELA DE BLOQUEO $\frac{5}{16}$ " DIAMETER x $\frac{1}{2}$ " x $\frac{1}{16}$ "		10 PCS
G	BOLT/ BOULON/ TORNILLO $\frac{5}{16}$ " DIAMETER x $1\frac{3}{4}$ " LENGTH		10 PCS
H	ALLEN KEY/ CLÉ ALLEN/ LLAVE INGLESA ALLEN $\frac{3}{16}$ "		1 PC
I	SCREW/ VIS/ TORNILLO M4 x $1\frac{1}{4}$ " LENGTH		16 PCS
J	BOLT/ BOULON/ TORNILLO $\frac{1}{4}$ " DIAMETER x 2" LENGTH		10 PCS
K	FLAT WASHER/ RONDELLE PLATE/ ARANDELA PLANA $\frac{1}{4}$ " DIAMETER x $\frac{3}{4}$ " x $\frac{1}{16}$ "		10 PCS
L	LOCK WASHER/ RONDELLE DE BLOCAGE/ ARANDELA DE BLOQUEO $\frac{1}{4}$ " DIAMETER x $\frac{1}{2}$ " x $\frac{1}{16}$ "		10 PCS

### LIST OF PARTS AND HARDWARE/ LISTE DES PIÈCES ET DU MATÉRIEL/ LISTA DE PIEZAS Y HARDWARE

NO#/ NOMBRE/ NÚMERO	DESCRIPTION/ DESCRIPTION/ DESCRIPCIÓN		QUANTITY/ QUANTITÉ/ CANTIDAD
1	HEADBOARD/ TÊTE DE LIT/ CABECERA		1 PC
2	KD LEFT HEADBOARD LEG/ JAMBE GAUCHE DE TÊTE DE LIT KD/ PATA IZQUIERDA KD PARA CABEZERA		1 PC
3	KD RIGHT HEADBOARD LEG/ JAMBE DROITE DE TÊTE DE LIT KD/ PATA DERECHA KD PARA CABEZERA		1 PC
4	WOOD MENDING PLATE/ PLAQUE DE RÉPARATION/ PLACA DE REPARACIÓN		2 PCS
5	BOTTOM RAIL/ RAIL INFÉRIEUR/ RIEL INFERIOR		1 PC
6	FOOTBOARD/ PIED DE LIT/ ESTRIBO		1 PC
7	SIDE RAIL / RAIL LATÉRAL / CARRIL LATERAL		2 PCS
8	SLAT/ LATTE/ LISTÓN		4 PCS
9	SLAT SUPPORT LEG/ JAMBE D'APPUI/ PIERNA DE APOYO		12 PCS
10	SIDE RAIL CLEAT/ PINCE DE RAIL LATÉRAL/ CALA LATERAL DEL CARRIL		2 PCS

NOTE:  
SPIRIT LEVELER NOT INCLUDED BUT NEEDED TO EVEN THE FLOOR.  
SPIRIT LEVELER NON INCLUS MAIS NÉCESSAIRE MÊME LE SOL.  
NIVELADOR DE ESPÍRITU NO INCLUIDO PERO ES NECESARIO PARA INCLUSO EL PISO.

# ASSEMBLY INSTRUCTIONS INSTRUCTIONS DE MONTAGE INSTRUCCIONES DE MONTAJE

## CAL KING PANEL BED WITH METAL HEADBOARD

Note:

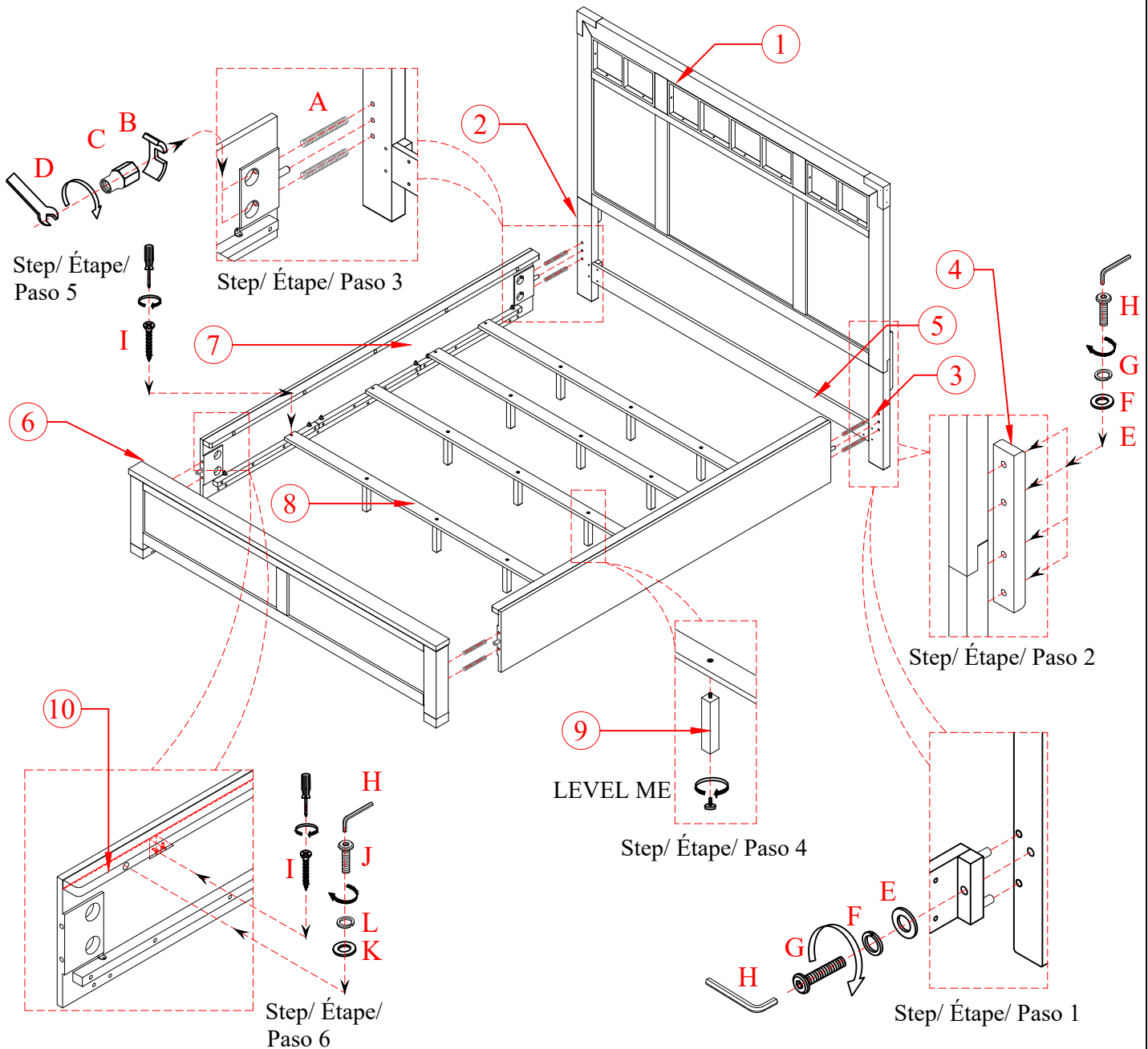
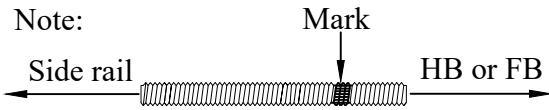

NOTE:  
SPIRIT LEVELER NOT INCLUDED BUT NEEDED TO EVEN THE FLOOR.  
SPIRIT LEVELER NON INCLUS MAIS NÉCESSAIRE MÊME LE SOL.  
NIVELADOR DE ESPÍRITU NO INCLUIDO PERO ES NECESARIO PARA INCLUSO EL PISO.

# ASSEMBLY INSTRUCTIONS INSTRUCTIONS DE MONTAGE INSTRUCCIONES DE MONTAJE

## CAL KING PANEL BED WITH METAL HEADBOARD

**CAUTION:** PLEASE READ ALL INSTRUCTIONS BEFORE STARTING THE ASSEMBLY OF THIS PRODUCT. THESE PIECES ARE HEAVY. IN ORDER TO PREVENT PERSONAL INJURY AND ENSURE THAT THIS PRODUCT IS NOT DAMAGED DURING THE ASSEMBLY PROCESS, IT IS STRONGLY RECOMMENDED TO ENLIST THE ASSISTANCE OF ONE OR MORE PERSONS. IN CASE OF EXCESS STAIN, WIPE THE BOTTOM OF THE UNIT BEFORE PLACING ON ANY SURFACE.

**ATTENTION:** VEUILLEZ LIRE TOUTES LES INSTRUCTIONS AVANT DE COMMENCER L'ASSEMBLAGE DE CE PRODUIT. LES PIECES SONT LOURDES. POUR EVITER TOUTE BLESSURE ET POUR VOUS. ASSURER QUE LE PRODUIT N'EST PAS ENDOMMAGE' PENDANT L'ASSEMBLAGE, NOUS VOUS RECOMMANDONS DE FAIRE APPEL A UNE OU PLUSIEURS AUTRES PERSONNES. EN CAS DE TACHE EXCESSIVE, ESSUYEZ LE FOND DE L'UNITE' AVANT LE PLACEMENT SUR N'IMPORTE QUELLE SURFACE.

**CUIDADO:** FAVOR DE LEER TODAS LAS INSTRUCCIONES ANTES DE ENSAMBLAR SU PRODUCTO, ESTAS. PIEZAS SON PESADAS. PARA PREVENIR HERIDAS PERSONALES Y ASEGURAR QUE SU PRODUCTO NO SEA DAN ADO MIENTRAS ES ENSAMBLADO. SE RECOMIENDA LA ASISTENCIA DE UNA O MAUS PERSONAS.

**WARNING:** PROTECTIVE GLIDE IS PLACED UNDER EACH LEG OF THE FURNITURE TO RESIST SCRATCHES ON FLOOR SURFACE. SOME FLOOR SURFACES CAN BE EXTRA SENSITIVE TO SCRATCHES AND MARKINGS, IF YOU ARE NOT SURE CONSULT WITH YOUR DEALER. AVERTISSEMENT. LES PIEDS DES MEUBLES SONT MUNIS DE PATINS DESTINES A PROTEGER LE PLANCHER. CERTAINS REVETEMENTS DE SOL PEUVENT ETRE TRES FRAGILES. EN CAS DE DOUTE. CONSULTER LE MARCHAND.

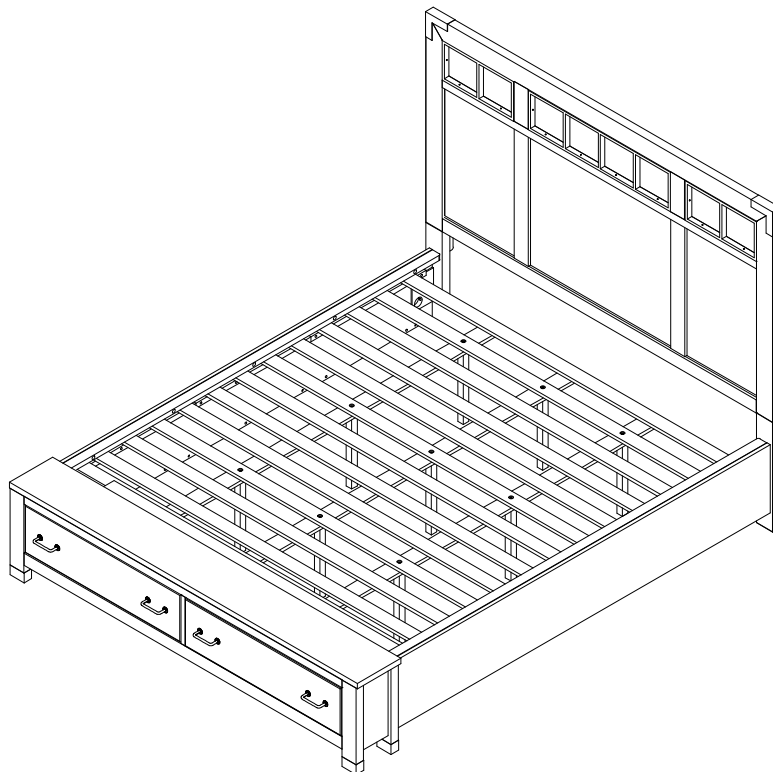

NOTE:  
ASSEMBLE UNIT ON A SOFT SURFACE.  
ASSEMBLEZ L'UNITÉ SUR UNE SURFACE MOLLE.  
ENSAMBLE LA UNIDAD EN UNA SUPERFICIE PLANA Y SUAVE.

DO NOT TIGHTEN BOLTS UNTIL **ALL PARTS AND HARDWARE OF** THE UNIT ARE ASSEMBLED.  
NE SERREZ PAS LES BOULONS JUSQU'À CE QUE L'UNITÉ SOIT COMPLÈTEMENT ASSEMBLÉE.  
NO APRIETE LOS TORNILLOS HASTA QUE LA UNIDAD ESTE COMPLETAMENTE ENSAMBLADA.













# ASSEMBLY INSTRUCTIONS

## INSTRUCTIONS DE MONTAGE













## INSTRUCCIONES DE MONTAJE

### CAL KING PANEL BED WITH METAL HEADBOARD

#### LIST OF PARTS AND HARDWARE/ LISTE DES PIÈCES ET DU MATÉRIEL/ LISTA DE PIEZAS Y HARDWARE

NO#/ NOMBRE/ NÚMERO	DESCRIPTION/ DESCRIPTION/ DESCRIPCIÓN		QUANTITY/ QUANTITÉ/ CANTIDAD
A	BOLT/ BOULON/ TORNILLO $\frac{5}{16}$ " DIAMETER x 4 $\frac{1}{2}$ " LENGTH		8 PCS
B	LOCK WASHER "C"/ RONDELLE DE BLOCAGE "C"/ ARANDELA DE BLOQUEO "C" $\frac{5}{16}$ " DIAMETER		8 PCS
C	NUT/ ÉCROU/ NUEZ $\frac{5}{16}$ " DIAMETER		8 PCS
D	WRENCH/ CLÉ/ LLAVE INGLESA $\frac{1}{2}$ "		1 PC
E	FLAT WASHER/ RONDELLE PLATE/ ARANDELA PLANA $\frac{5}{16}$ " DIAMETER x $\frac{3}{4}$ " x $\frac{1}{16}$ "		12 PCS
F	LOCK WASHER/ RONDELLE DE BLOCAGE/ ARANDELA DE BLOQUEO $\frac{5}{16}$ " DIAMETER x $\frac{1}{2}$ " x $\frac{1}{16}$ "		12 PCS
G	BOLT/ BOULON/ TORNILLO 5/16" DIAMETER x 1 $\frac{3}{4}$ " LENGTH		12 PCS
H	ALLEN KEY/ CLÉ ALLEN/ LLAVE INGLESA ALLEN $\frac{3}{16}$ "		1 PC
I	SCREW/ VIS/ TORNILLO M4 x 1 $\frac{1}{4}$ " LENGTH		29 PCS
J	BOLT/ BOULON/ TORNILLO $\frac{1}{4}$ " DIAMETER x 2" LENGTH		10 PCS
K	FLAT WASHER/ RONDELLE PLATE/ ARANDELA PLANA $\frac{1}{4}$ " DIAMETER x $\frac{3}{4}$ " x $\frac{1}{16}$ "		10 PCS
L	LOCK WASHER/ RONDELLE DE BLOCAGE/ ARANDELA DE BLOQUEO $\frac{1}{4}$ " DIAMETER x $\frac{1}{2}$ " x $\frac{1}{16}$ "		10 PCS

#### LIST OF PARTS AND HARDWARE/ LISTE DES PIÈCES ET DU MATÉRIEL/ LISTA DE PIEZAS Y HARDWARE

NO#/ NOMBRE/ NÚMERO	DESCRIPTION/ DESCRIPTION/ DESCRIPCIÓN		QUANTITY/ QUANTITÉ/ CANTIDAD
1	HEADBOARD/ TÊTE DE LIT/ CABECERA		1 PC
2	KD LEFT HEADBOARD LEG/ JAMBE GAUCHE DE TÊTE DE LIT KD/ PATA IZQUIERDA KD PARA CABEZERA		1 PC
3	KD RIGHT HEADBOARD LEG/ JAMBE DROITE DE TÊTE DE LIT KD/ PATA DERECHA KD PARA CABEZERA		1 PC
4	WOOD MENDING PLATE/ PLAQUE DE RÉPARATION/ PLACA DE REPARACIÓN		2 PCS
5	BOTTOM RAIL/ RAIL INFÉRIEUR/ RIEL INFERIOR		1 PC
6	FOOTBOARD/ PIED DE LIT/ ESTRIBO		1 PC
7	SIDE RAIL / RAIL LATÉRAL / CARRIL LATERAL		2 PCS
8	SLAT ROLL/ ROULEAU DE LATTES/ ROLLO DE LISTONES		13 PCS
9	BOTTOM SLAT "A"/ LATTE INFÉRIEURE "A"/ LISTÓN INFERIOR "A"		2 PCS
10	BOTTOM SLAT "B"/ LATTE INFÉRIEURE "B"/ LISTÓN INFERIOR "B"		2 PCS
11	SLAT SUPPORT LEG/ JAMBE D'APPUI/ PIERNA DE APOYO		6 PCS
12	SIDE RAIL CLEAT/ PINCE DE RAIL LATÉRAL/ CALA LATERAL DEL CARRIL		2 PCS

NOTE:  
SPIRIT LEVELER NOT INCLUDED BUT NEEDED TO EVEN THE FLOOR.  
SPIRIT LEVELER NON INCLUS MAIS NÉCESSAIRE MÊME LE SOL.  
NIVELADOR DE ESPÍRITU NO INCLUIDO PERO ES NECESARIO PARA INCLUSO EL PISO.

# ASSEMBLY INSTRUCTIONS INSTRUCTIONS DE MONTAGE INSTRUCCIONES DE MONTAJE

## CAL KING PANEL BED WITH METAL HEADBOARD

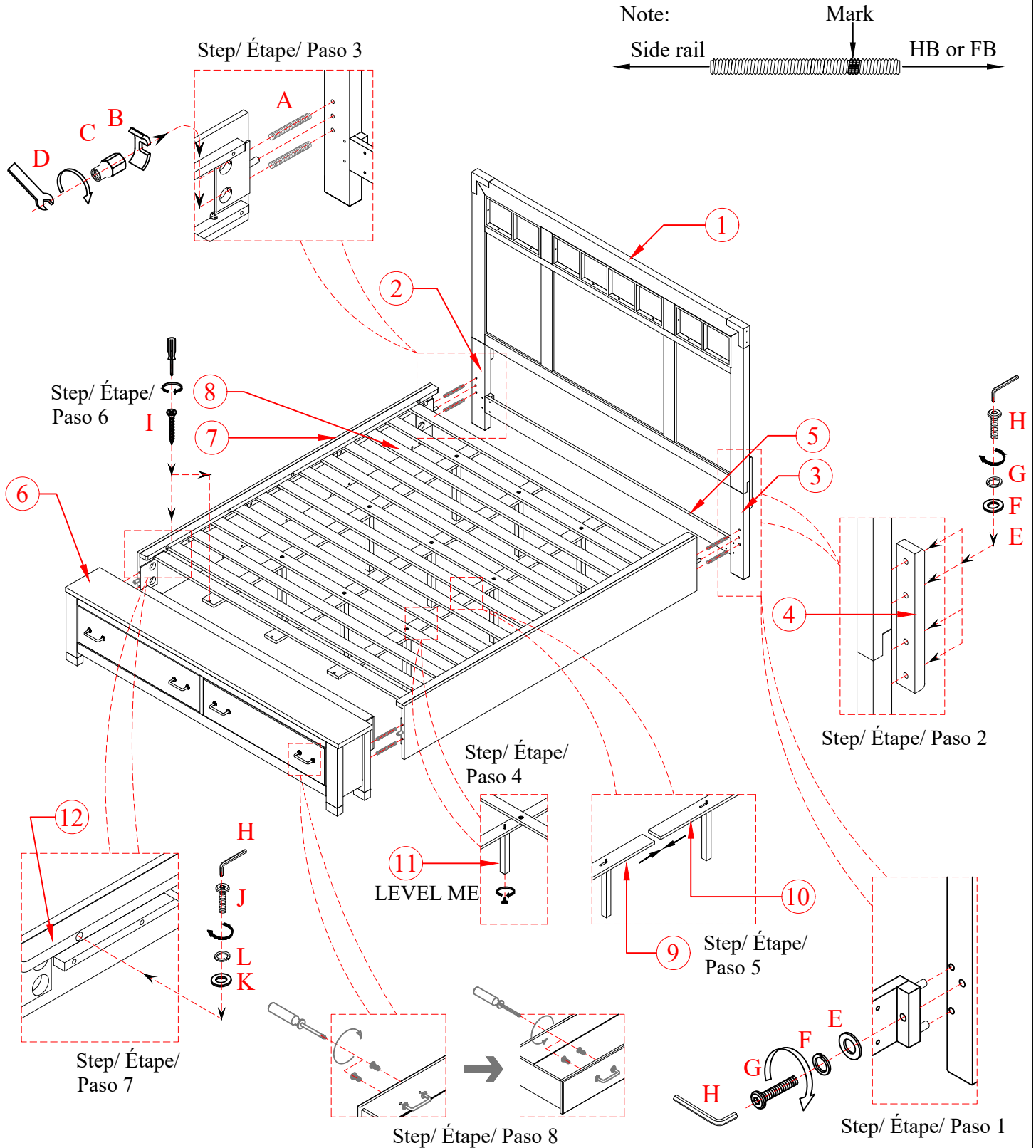

NOTE:  
SPIRIT LEVELER NOT INCLUDED BUT NEEDED TO EVEN THE FLOOR.  
SPIRIT LEVELER NON INCLUS MAIS NÉCESSAIRE MÊME LE SOL.  
NIVELADOR DE ESPÍRITU NO INCLUIDO PERO ES NECESARIO PARA INCLUSO EL PISO.