

ASSEMBLY INSTRUCTIONS



CAUTION

◆ Inspect the wire insulation for any cuts, abrasions, or exposed copper that may have resulted during shipping. If there is a defect in the wire, do not attempt installation.

◆ Before starting installation of this fixture or removal of a previous fixture, disconnect the power by turning off the circuit breaker or by removing the fuse at the fuse box.

TOOLS REQUIRED



Ladder



Safety glasses



Electrical tape



Phillips screwdriver



Flat blade screwdriver



Pliers

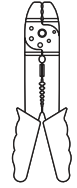

Wire strippers

* PARTS SHOWN MAY DIFFER SLIGHTLY PER LIGHT FIXTURE

HARDWARE INCLUDED

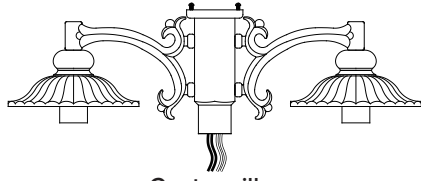

Center pillar
(Screws A)

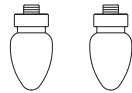

Decorative nut

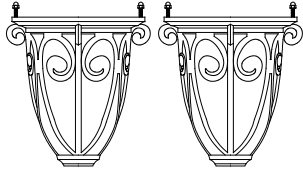

Cage
(Nuts, Screws B)

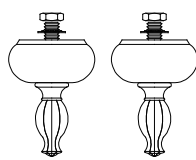

Finial
(Hex nuts A, Washer)



Cover

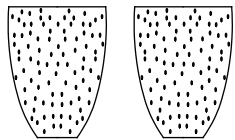

Glass shade



tabs

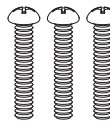

screws (Thick)

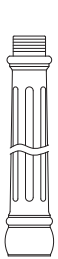

Decorative Pillar
(TOP)

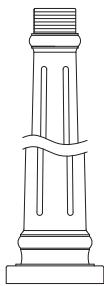

Decorative Pillar
(MIDDLE)

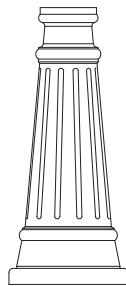

Decorative Pillar
(BOTTOM)

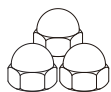

Big Cap Nuts



Electric Wire



Wire Nuts

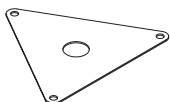

A Tripod

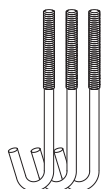

Iron Hook



Hex Nuts B

EXPLODED PARTS

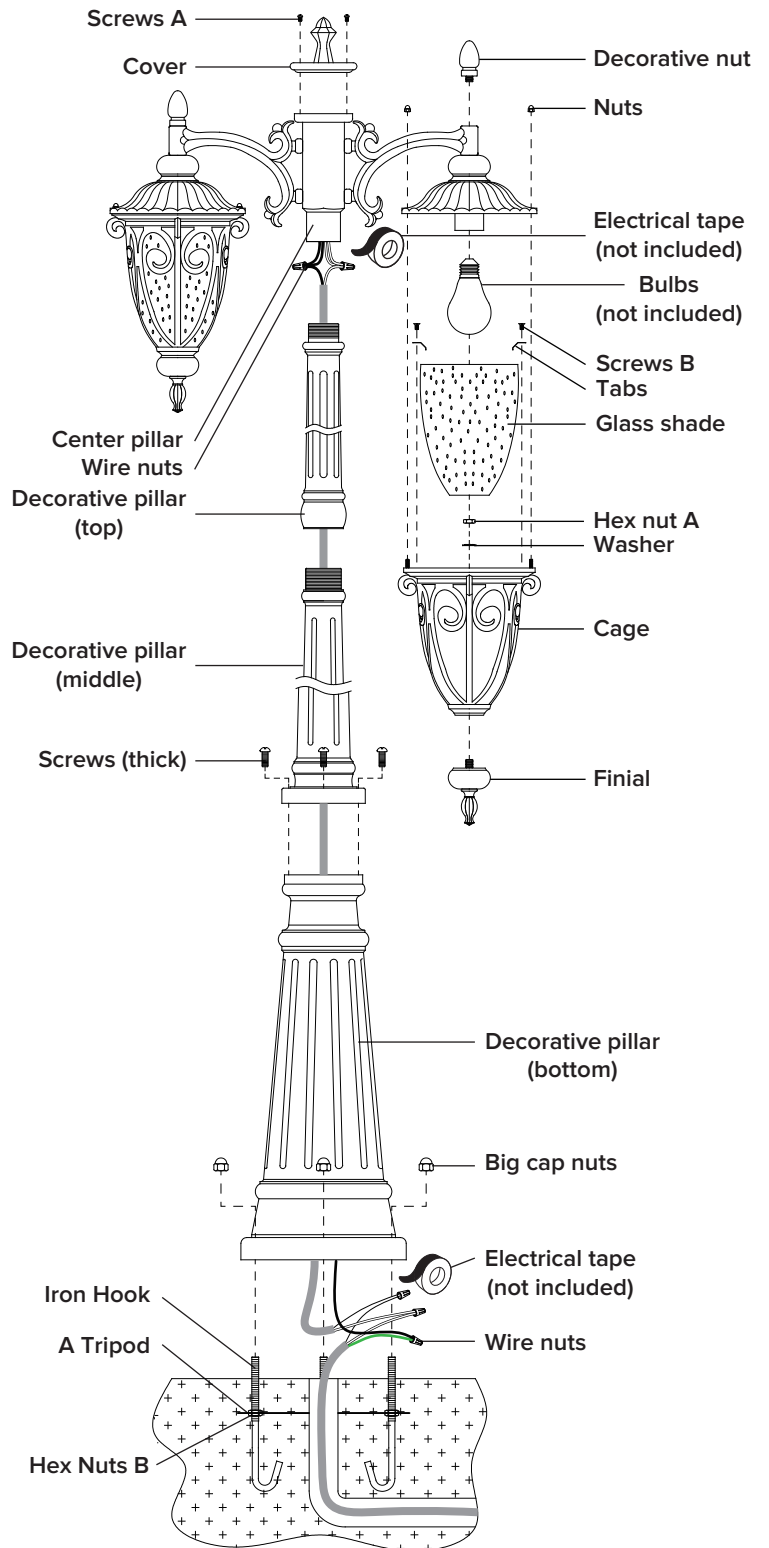

INSTALLATION

STEP 1

Install **iron hook** into the **a tripod** with the **hex nuts B** then embed the component in the ground level with concrete.

Note: the threaded nipple must protrude outward 1 5/8"(41 mm).

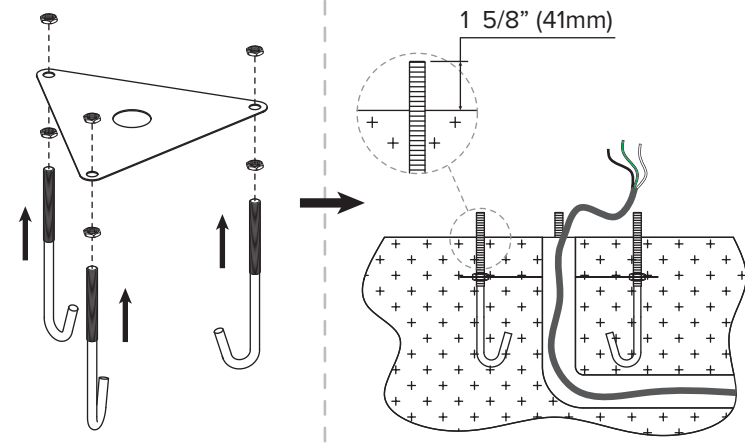

STEP 2

connect the black wire and white wire with the supplied wire nuts. Secure with electrical tape(not included). Then carefully tuck wires back into the **center pillar**.

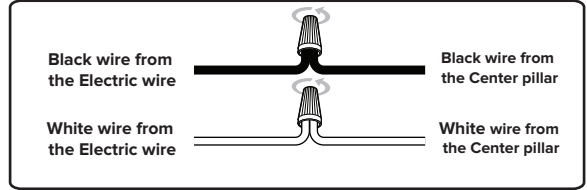
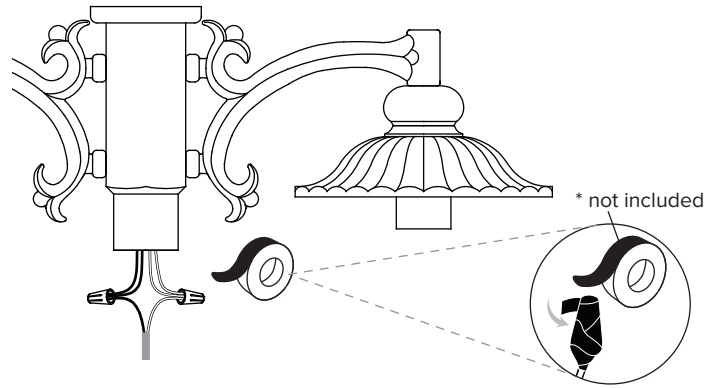

STEP 3

- 1.Remove the **screws A** from the **center pillar**.
- 2.Install the **cover** into **center pillar** and secure with **screws B**.

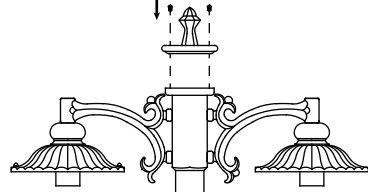

STEP 5

1. Remove the **hex nut A** and **washer** from the **finial**.
2. Use the **hex nut A** and **washer** to attach the **finial** to the **cage**.

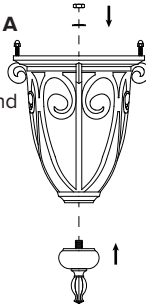

STEP 7

Install bulb (not included)

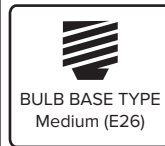
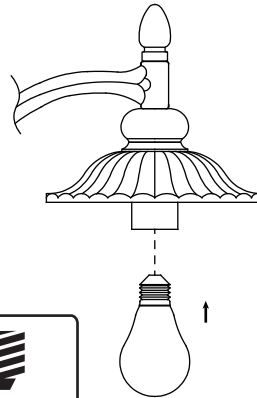

STEP 8

1. Remove the **nuts** from the **cage**.
2. Install the **cage** into **center pillar** and secure with **nuts**.

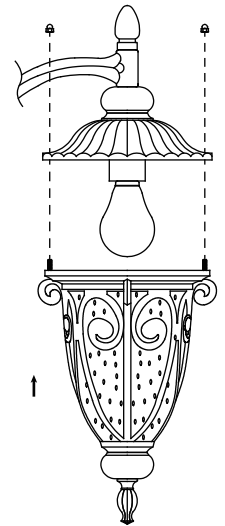

STEP 4

Install **decorative nut**.

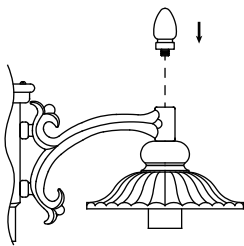

STEP 6

1. Remove the **screws B** from the **cage**.
2. Install the **Glass shade** into **cage** and secure with **screws B** and **tabs**.

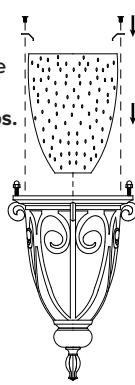

STEP 9

Pass through the **electric wire** into **decorative pillar(top)** and **decorative pillar(middle)**. Secure the **decorative pillar(top)** into **center pillar**,then secure the **decorative pillar(middle)** into **decorative pillar(bottom)**.

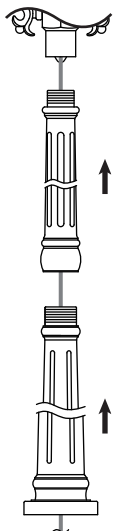

STEP 10

Pass through the **electric wire** into **decorative pillar(bottom)**, attach the **decorative pillar(bottom)** onto **decorative pillar(middle)** using **screws(thick)**.

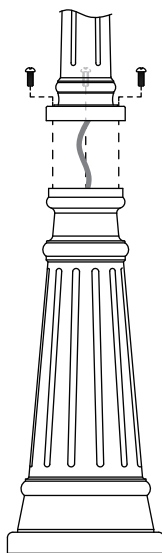

STEP 11

Connect the live wire, neutral wire and ground wire with the supplied **wire nuts**. Secure with electrical tape(not included).

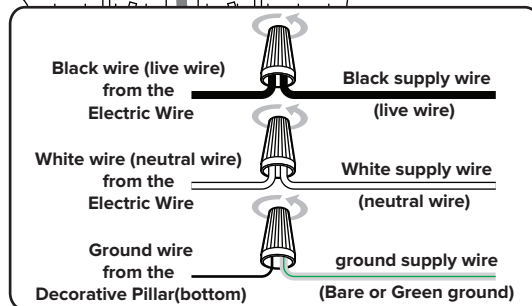
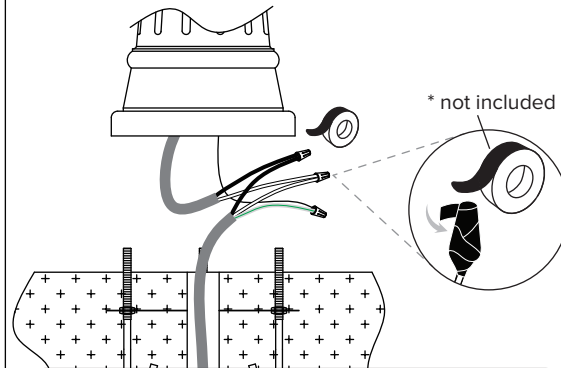

STEP 12

Attach the **decorative pillar to (bottom)** to the **iron hook** through screw holes, and secure it with **big cap nuts**.

