

Step:21

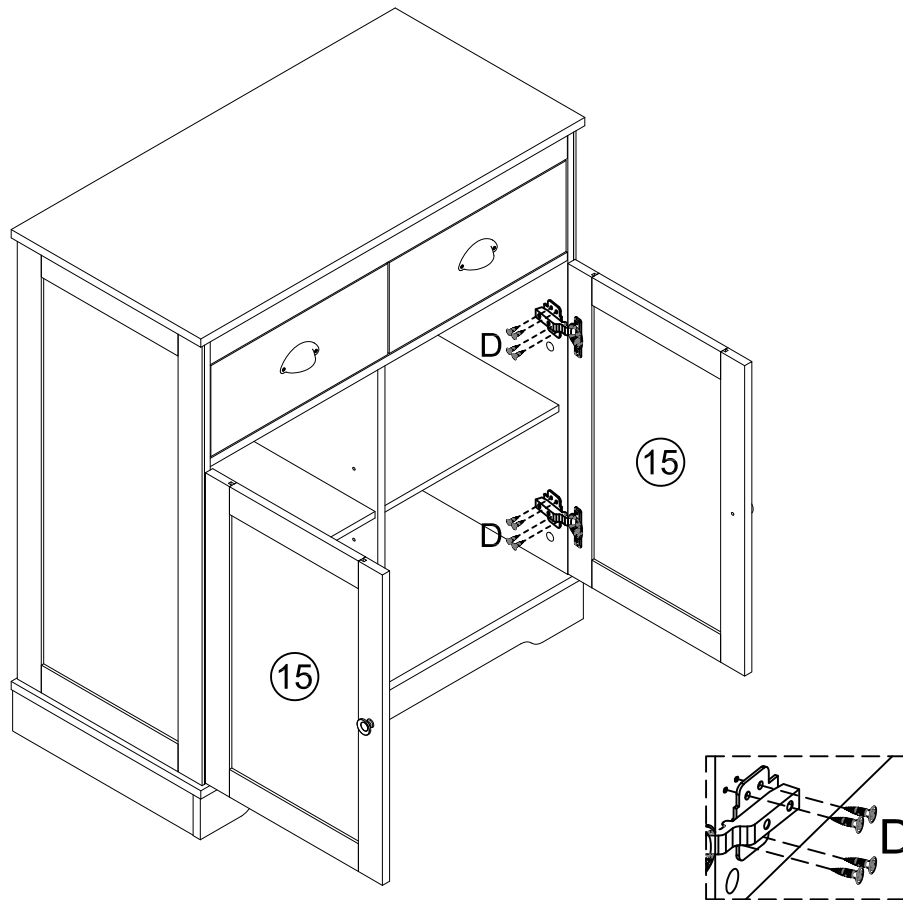

Installation method of hinge

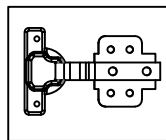

Tighten the lead holes

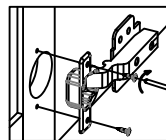

Align at the lead hole and don't twist it tightly

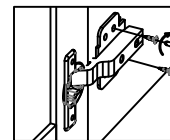

Adjustment of front and back

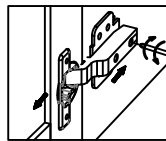

Adjustment of left and right

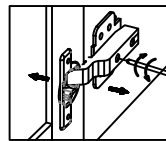

Tighten after proper adjustment up and down

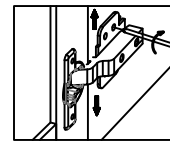

D x 16PCS