

INSTRUCTION MANUAL

Outdoor Side Table



Keep the Instructions for Future Reference.
If you purchased the furniture on-line and have any
questions or concerns please contact us with email.
Email: slhhomegarden@outlook.com

WARNING:

The table is not to be used for standing purposes and will not function as a step-ladder. Use on even surfaces only. The table tested for use at weight of 50 lbs. Improper use of this product or failure to use as directed may result in injury.

IMPORTANT:

Please read all the instructions and warnings before assembling. In order to make the whole product adjust to the best, please install all the screws on the product before fully tighten and note to put the washer to the screw before putting the screw into the screw hole.

SAFETY INFORMATION:

- Keep all children and pets away from assembly area. Children and pets should be supervised when they are in the area of the product construction.
- Keep assembly area at least 6 feet from any obstruction such as a fence, garage, house, overhanging branches, laundry line or electrical wires.
- Some parts may contain sharp edges. When assembling and using this product, basic safety precautions should always be followed to reduce the risk of personal injury and damage to the product. Please read all instructions before assembly and use.
- Check all bolts for tightness before use, IMPORTANT-check and tighten bolts often to keep them secure!
- The table is not to be used for standing purposes and will not function as a tool or step-ladder. Use on even surfaces only.

CARE & MAINTENANCE:

- **STAIN RESISTANT CUSHIONS CARE: KEEP THE CUSHIONS IN STORAGE IN RAINY DAYS**
- **SPILLS:** Immediately wipe up the spill using a white damp cloth. Repeat process if necessary until stain is gone. Allow cushion to air dry.
- **FABRIC CARE:** Hand wash only, non-chlorine bleach when needed, lay flat to dry. Cool iron if necessary. Do not dry clean.
- **RESIN WICKER PRODUCT CARE:** Before using, clean the product completely with a soft dry towel. When not in use, wipe free of any dirt or loose objects, wash with a mild solution of soap and water, rinse thoroughly and dry completely. Do not use strong detergent or abrasive cleaners. Over time nuts and bolts can loosen. Occasionally, check nuts and bolts on furniture, re-tighten if necessary.
- **RUST PREVENTION:** Use a waterproof furniture cover during rain or snow, or any shield that can be covered.

Part List ▼ |||

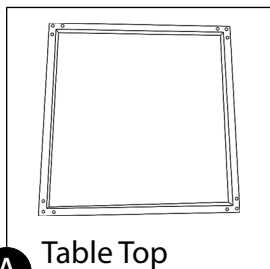

A Table Top
x 1

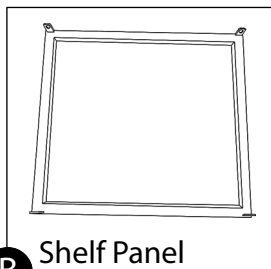

B Shelf Panel
x 1



C Table Leg 1
x 2



D Table Leg 2
x 2

Hardware ▼ |||

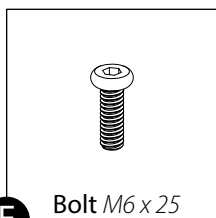

E Bolt M6 x 25
x 16

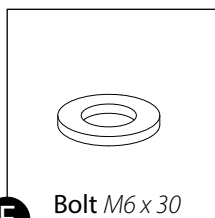

F Bolt M6 x 30
x 16

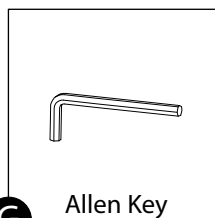

G Allen Key
x 1



1 Person Assembly

ASSEMBLY TIP:

Please screw the parts together at 80% loose, it will help you assemble them easily. When all the parts are assembled together, tighten the screws up 100% in the end to make the product stable.

STEP 1 • Attach Table Legs (C) & (D) to Table Top (A) using Bolts (E) and Washers (F) as shown.

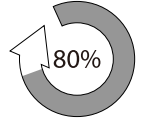
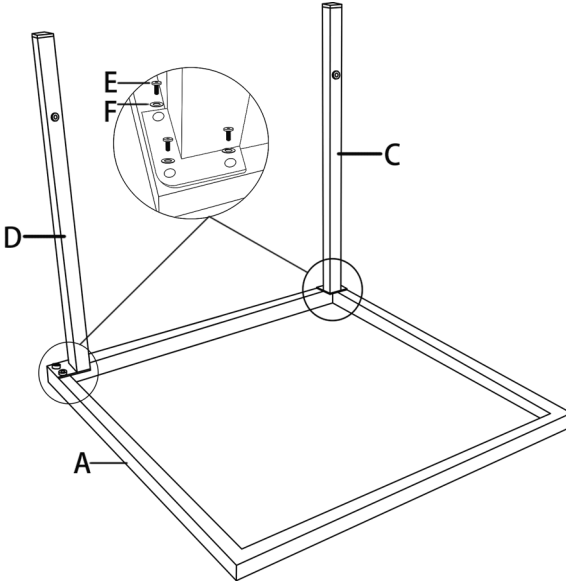

Tighten the bolts to 80% tightness

STEP 2 • Attach the Other Table Legs (C) & (D) to Table Top (A) using Bolts (E) and Washers (F) as shown.

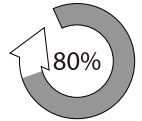
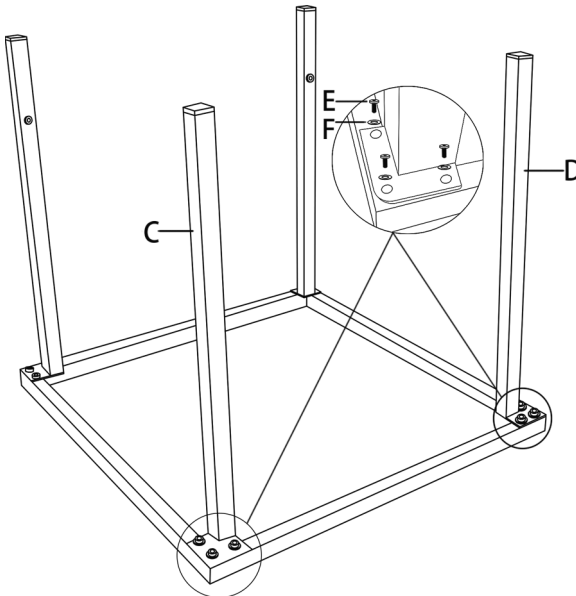

Tighten the bolts to 80% tightness

STEP
3

• Attach Shelf Panel (B) to Table Legs using Bolts (E) and Washers (F) as shown.

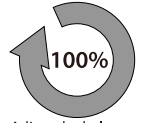
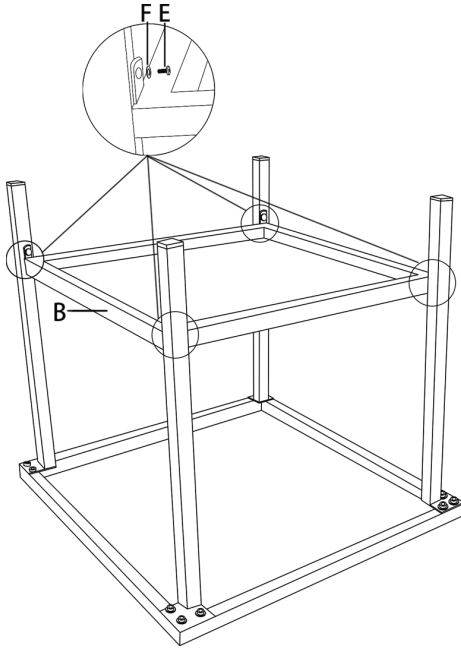

Adjust the balance
of the table and
tighten the bolts
to 100% tightness



